



Background

The components of a specific piece of air conditioning or refrigeration equipment have been engineered specifically around the properties of the refrigerant used. When replacement of that refrigerant becomes necessary for technical, regulatory, or economic reasons, the replacement refrigerant should have as many properties similar to the original refrigerant as possible. This will minimize hardware changes, controls adjustments, or other time consuming operations such as oil changes.

Since the late 1980s, the development of blends has focused on matching the properties of the original refrigerant in order to offer some advantage over the competing blends. Early R-12 blends focused on evaporator performance in refrigeration systems; however, it became clear that more R-12 was sold for use in automotive air conditioning rather than in refrigeration. Since these systems experience higher condenser temperatures, a second wave of blends came into the market that had lower head pressures.

Manufacturers introduced R-502 retrofit blends that simply removed the R-115, a CFC, and mixed HFC components with R-22. While this approach was very effective at reducing R-502 use during the transition away from CFCs in the mid 1990's, it now leaves equipment owners with the challenge of replacing the HCFC-based blends again.

As early as 1992, manufacturers and suppliers of R-22 based air conditioning equipment were looking for alternatives. While the focus was mainly on replacing R-22 for newly built equipment, several retrofit blends were also identified in the process.

Today

2010 begins the first year of restriction on the use of R-22 in new equipment. Although R-22 will still be available for servicing, available quantities will be more and more limited and the need for retrofitting will increase. Some market applications, such as residential and commercial air conditioning, have not had to deal with the product restrictions that have occurred over the last 15 years. They will now see many new products that behave dramatically different than R-22.

Blends Tutorial

The following information is designed to help technicians understand how blends are different from single-component refrigerants. Fractionation and temperature glide are explained in a way that shows the effect on system operation and controls. Actual products and their impact on the market are discussed, and retrofit procedures are provided for a variety of products and equipment.



Single Components vs. Blends

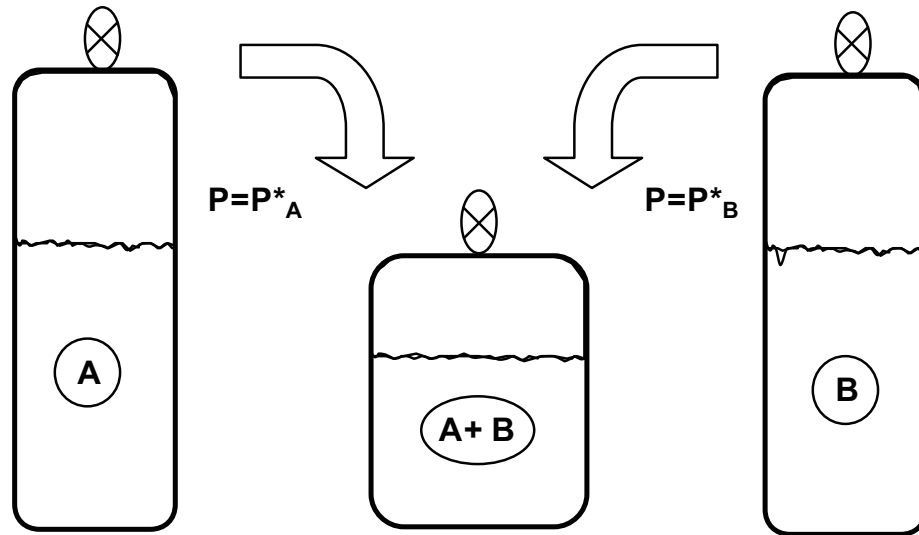

By Convention, Higher Pressure Component is First ($P^*_A > P^*_B$)

Blends are made up of two or more single component refrigerants. When mixing refrigerants, for example, refrigerant "A" and refrigerant "B", we generally speak about the higher pressure, higher capacity component first. For purposes of this tutorial, "A" will be the higher pressure product.

When two or more refrigerants are placed into the same container, one of two situations will occur, depending on how strongly the different molecules are attracted to each other:

Azeotrope: a blend that behaves like a single component refrigerant. When a blend forms an azeotrope, it displays unique and unexpected properties.

Zeotrope: a blend that behaves like a mixture of the individual components. Zeotropes have predictable properties based on combinations of the pure components' properties.

Two properties of concern are Fractionation and Temperature Glide. We can split the zeotropic blends into Low Fractionation Potential, which also exhibit Low Temperature Glide, and High Fractionation Potential, which also exhibit High Temperature Glide. Generally speaking, zeotropic blends with lower temperature glides do not show the same problems with fractionation that are seen with higher glide blends.



Pressure Temperature Curves for Refrigerant Blends

Azeotropic Behavior

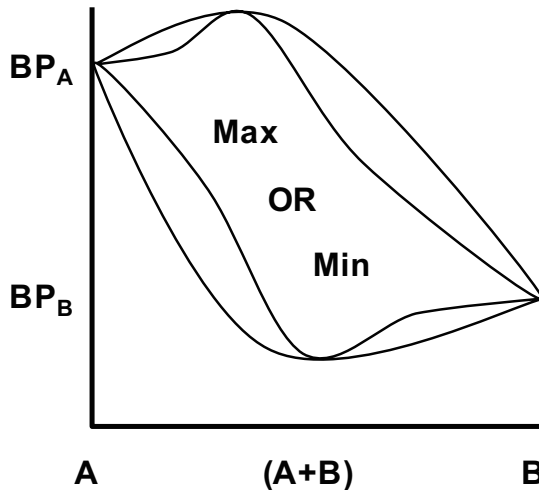

Zeotropic Behavior

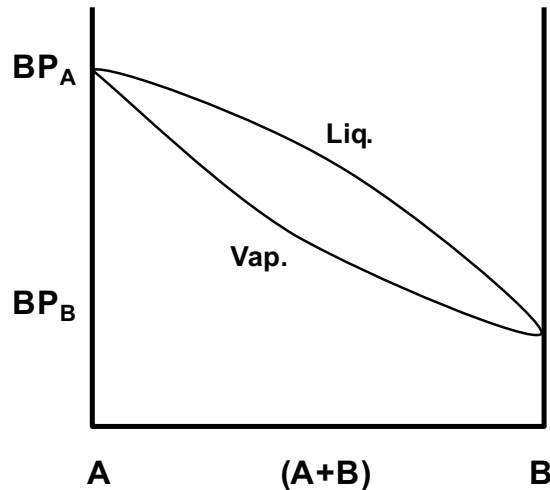

Azeotrope: a special case where the refrigerants combine in a unique way. In an azeotropic composition, the blend behaves like a single refrigerant with its own pressure-temperature (P-T) relationship. The pressure after mixing is either higher than the pressures of the individual components, or is lower than either component. Because the refrigerants are attracted to each other in a special way, the vapor in equilibrium with the liquid is at the same composition during phase change.

Note: The azeotropic composition depends on temperature. The same combination of refrigerants may form an azeotrope at a different ratio, or not at all, at some other temperature.

Zeotrope: the P-T relationship is a natural combination of the components' properties. The pressure for the blend falls between the pressures of its components and can be calculated according to established formulas. Considering the P-T relationship for each refrigerant, the resulting pressure and the vapor composition above the liquid for any given liquid composition can be calculated.

In general, if a lot of A is mixed with B, then the blend will have a pressure close to A. If more B is in the mix, then the blend will have a pressure close to B. If you mix equal amounts, the resulting pressure will fall in between. Blend compositions can be adjusted so the blend properties fall exactly where you want. The problem, however, is that you usually can't get all the properties to match the original refrigerant under all conditions. You must trade off which properties you want to match and which ones that will be different.

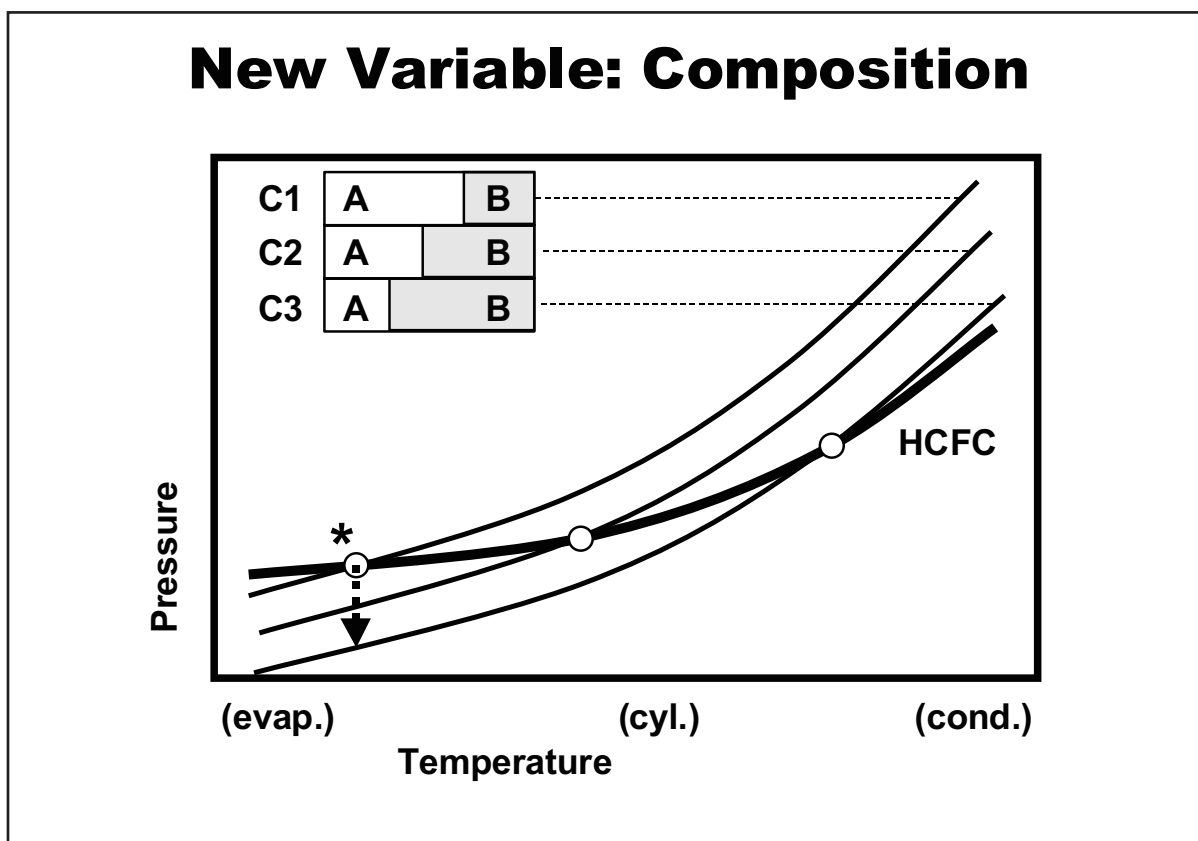

Once a blend is mixed at a given composition, the pressure-temperature relationships follow the same general rules for pure components; for example, the pressure goes up when the temperature goes up. For three blends containing different amounts of A and B, the pressure curve is similarly shaped, but the resulting pressure will be higher for the blend which contains more of the A (higher pressure) component.

Refrigerant blends that are intended to match some other product (R-22, for example) will rarely match the pressure at all points in the desired temperature range. More commonly, the pressure of the blend will match in one temperature range, but will be different elsewhere.

In the above example, the blend with concentration C1 matches the pure refrigerant at cold evaporator temperatures, but the pressure runs higher at condenser conditions. The blend with composition C2 matches closer to room temperature and, for example, might show the same pressure in a cylinder being stored. The operating pressures at evaporator and condenser temperatures, however, will be somewhat different. Finally, the blend at C3 will generate the same pressures at hot condenser conditions, but the evaporator must run at lower pressures to get the same temperature. The choice of where the blend matches the pressure relationship can solve (or cause) certain retrofit-related problems.

The other thing that can be seen from this graph is that if a blend loses some of the higher-pressure component through fractionation, the remaining blend will have lower operating pressures in order to achieve the same temperatures. (*)



Introduction to Fractionation: Behavior of Individual Refrigerant Molecules

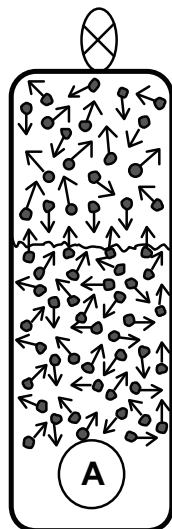

P_A Is Higher
(more movement)

In Zeotropic Mixtures
“A” refrigerant molecules
move independently from
“B” refrigerant molecules.

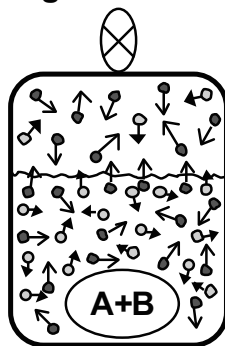

Combined P
A more active than B

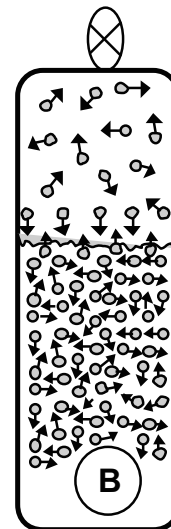

P_B Is Lower
(less movement)

There are two basic behaviors of refrigerant molecules that will help explain why fractionation occurs.

1. Pure refrigerants, A or B, exert pressure on the cylinder (or a system) because the molecules are moving around. At higher temperatures, they move around faster, which creates more pressure. At lower temperatures there is less movement, so the pressure is lower.

Different refrigerants have different energies at the same temperature, and therefore, generate higher or lower pressures.

2. Molecules of refrigerant are constantly moving from liquid to vapor and vapor to liquid at the surface of the liquid. Vapor and liquid at equilibrium transfer the same number of molecules back and forth; boiling liquid transfers more from liquid to vapor; and condensing vapor transfers more from vapor to liquid.

Different refrigerants transfer molecules back and forth to the vapor at different rates.

When you mix A and B together, and they don't form an azeotrope, the individual refrigerant molecules behave as if the other type is not there. The A's bounce harder than the B's, contributing more pressure to the blend, but more importantly - *the A's transfer back and forth to the vapor faster than the B's*. This means there are more A's in the vapor than there are B's.



Fractionation of Blends

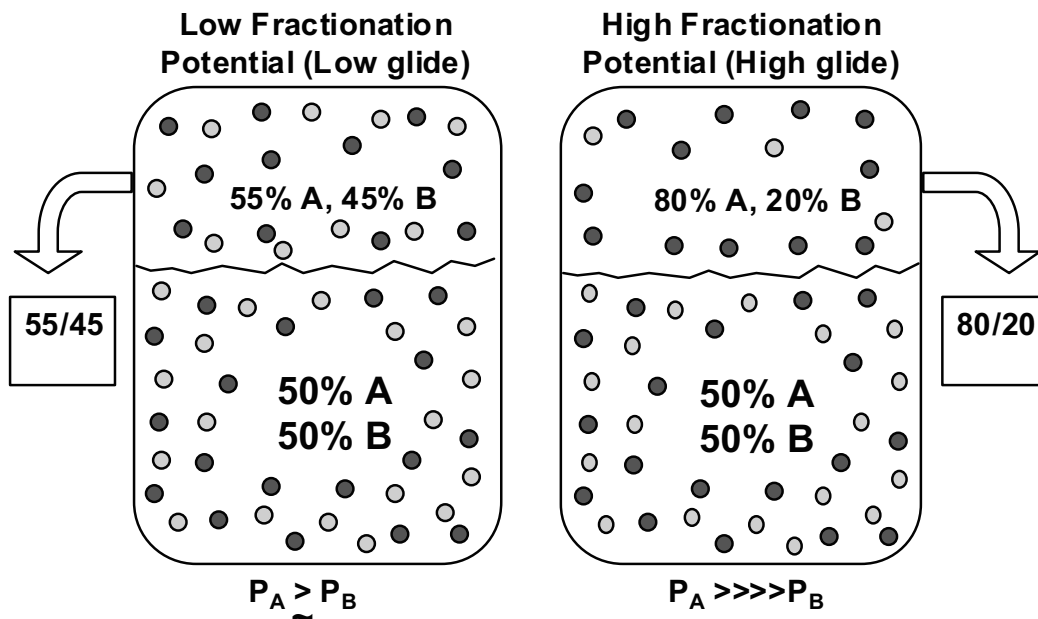

When vapor is removed from a cylinder or system containing a zeotropic blend, two things are going to happen: 1) the vapor being removed is at the wrong composition, so it will have more of the higher pressure/higher capacity refrigerant component; and 2) the liquid that is left behind boils more of the higher pressure component out of the liquid to replace the vapor. Eventually, the liquid composition changes because more of the A component leaves the container or system compared to the bulk liquid composition.

FRACTIONATION is the change in composition of a blend because one (or more) of the components is lost or removed faster than the other(s).

A large difference between the pressures of the starting components will cause a greater difference in the vapor composition compared to the liquid composition. This will worsen the effect of fractionation on that blend. The High Fractionation Potential blend shown above will produce a vapor composition of 80% A and 20% B above the liquid composition of 50/50.

Molecules will transfer back and forth to the vapor at a similar rate when the pressures of the individual components are close to each other. The Low Fractionation Potential blend shown above will have a very similar vapor composition compared to the liquid. In this case, it will take a long time to noticeably change the liquid composition away from 50/50.

Temperature Glide will be higher for High Fractionation blends, and lower for Low Fractionation blends.



Effects of Fractionation in a Cylinder

- Charge wrong composition - poor system behavior
- Leave behind wrong composition - rest of cylinder no good

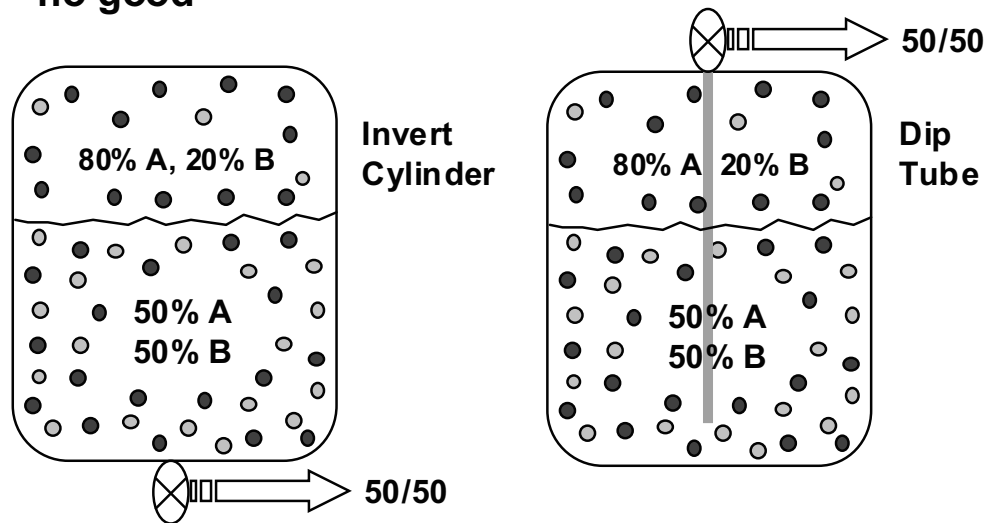

To avoid charging the wrong composition and fractionating the remaining blend, *zeotropic blends must be removed from the cylinder as a liquid*. This can be done by turning the cylinder over so the valve is on the bottom. For larger cylinders with two valves, use the 'liquid' valve. Liquid refrigerant will come up through a dip tube to the valve.

- * All refrigerant suppliers have removed dip tubes in their "30 lb." packages. Check the box or cylinder label for instructions on which side should be up for liquid removal.

"Liquid charging" does not mean that liquid refrigerant should be pushed into the suction line of the system, allowing it to slug the compressor. After the initial charge into the high side of a system, the technician should start the compressor and complete the charging process by flashing the refrigerant from liquid to vapor in the charging hose or across specially designed valves. Any method that allows the refrigerant to go to vapor before it hits the compressor should work. Generally, the refrigerant needs to be added slowly at this point.

Please note: When liquid and vapor are together in a cylinder or in a system, IT IS ALWAYS THE VAPOR THAT WILL BE AT THE WRONG COMPOSITION.



Fractionation Effects on System Charge

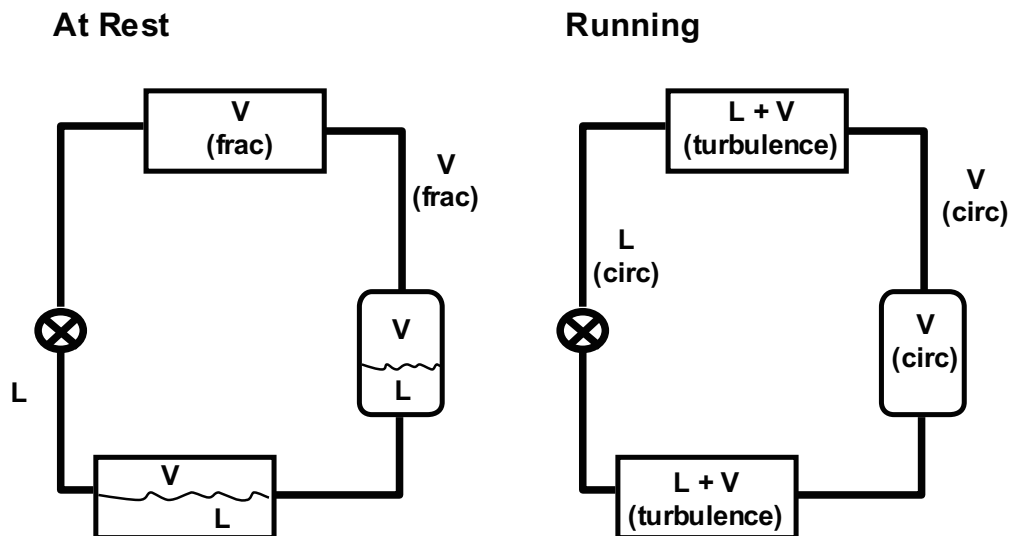

A system **at rest** will allow the refrigerant to pool and the vapor to come to an equilibrium concentration above the liquid. Leaks that occur in vapor areas of the equipment will fractionate the blend. The worst case will occur when about half of the refrigerant charge has leaked. Small amounts leaked from a system will not change the remaining blend by much. Large leaks will shift the composition, but the majority of the pounds after recharge will be from fresh product at the correct composition.

Recharging the system after repair will result in a blend with slightly reduced capacity and operating pressures. In smaller systems, where charge size is critical, it will be best to recover any remaining refrigerant and charge with fresh blend. In larger systems, you will need to make a decision whether the remaining charge should be recovered or not. Note: for Low Fractionation Potential blends you will not see much shift in composition anyway, and therefore the charge can be topped off after repair without loss of properties.

In **running systems** it has been found that the circulating composition is the original blend composition. In liquid and suction lines there is no second phase, and in the heat exchangers there is much turbulence so leaks will lose both vapor and liquid. Testing has shown that leaks from a running system do not cause fractionation, and a normally cycling system will not fractionate much during the off cycle.

In other words, in most refrigeration applications, servicing systems with blends does not require full recovery of the charge. After repair, most systems can be topped off with the blend. In most air conditioning systems, however, a leak during the off season will likely require a full change of refrigerant charge.



Fractionation Effects on Some System Components

Flooded Evaporator

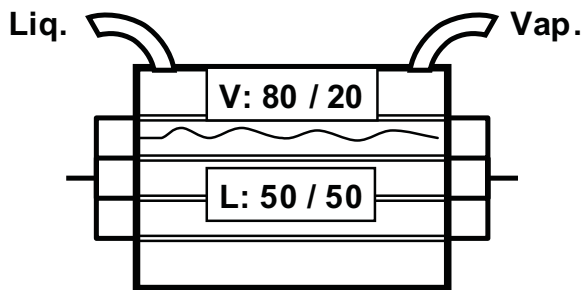

Continuous

Suction Accumulator

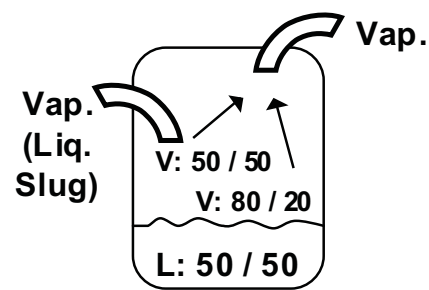

Periodic

Flooded Evaporators are designed to keep a pool of boiling liquid refrigerant surrounding a bundle of tubes. The water, brine, or product to be cooled flows through the tubes. The vapor that boils off this pool is returned to the compressor, condensed, and then poured back into the pool.

In the case of zeotropic blends, the vapor that boils off this pool of refrigerant will be at the fractionated composition. If the properties at this composition differ significantly from what the compressor expects, then the system could develop high head pressures, high amperage draw at the compressor, reduced cooling effectiveness (capacity) in the evaporator, etc. Normally the use of blends in this type of system is not recommended.

Suction Accumulators are placed in the suction line before the compressor to keep liquid from flowing into the compressor. The liquid slug is trapped in the accumulator where it can boil off to vapor, combining with other suction gas. Zeotropic blends will fractionate in the accumulator, giving a short-lived spike of higher-pressure vapor back to the compressor.

Systems with suction accumulators should not be overcharged with the expectation that the accumulator will protect the compressor. (This may lead to frequent pressure spikes.) Also, this type of system should never be charged by dumping liquid refrigerant into the suction line and allowing it to vaporize in the accumulator. (High pressure trips may occur.)



Temperature Glide in the Evaporator

Relationship between blend fractionation and temperature glide through evaporator tube:

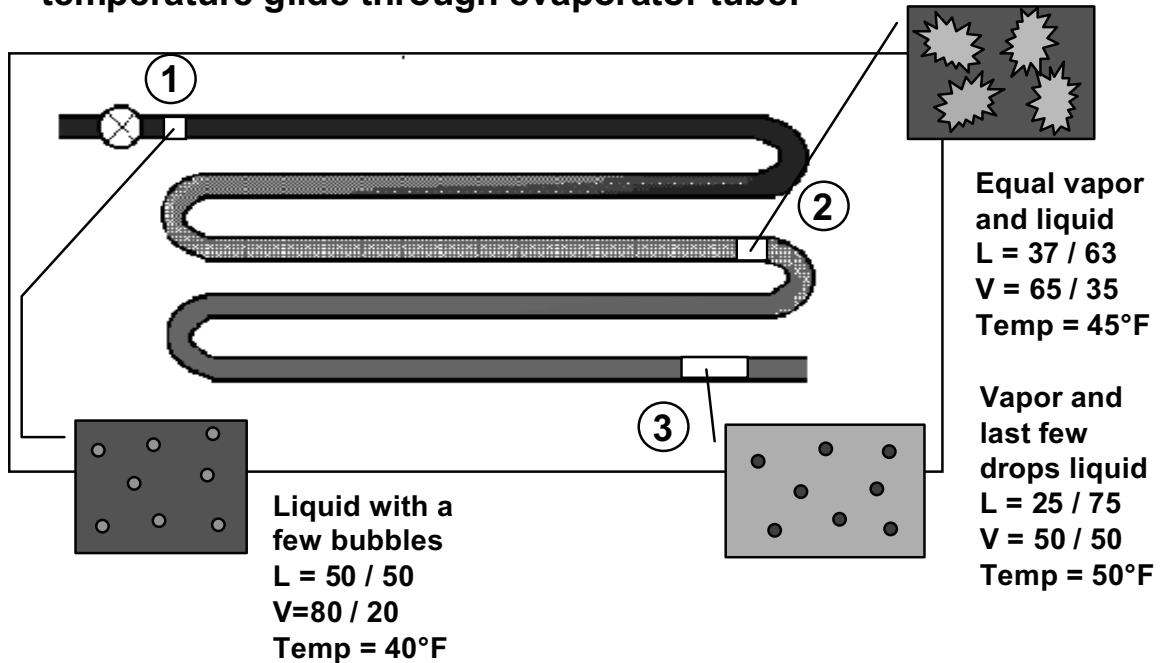

Let's assume that a blend of 50% A refrigerant and 50% B refrigerant flows across a valve into an evaporator coil. If we follow a small "piece" of the blend as it flows along the tube we can see the effect of fractionation:

1. At the beginning of the tube the blend is mostly liquid with a few bubbles in it. The liquid composition is 50/50 and the boiling point is (for purposes of discussion) 40°F.
2. As the "piece" of refrigerant marches along the tube, more liquid is boiled to vapor. Since A transfers to vapor faster than B, a larger proportion of A (than B) is transferred to vapor. This makes the composition of the liquid change along the length of the tube. In this example, the "piece of blend" which started at 50/50, now has a liquid composition at 37% A and 63% B. (The vapor has the extra A - at 65%.) The important point is that the boiling temperature of the current liquid composition is now about 45°F.
3. When our "piece" of the blend gets to the end of the evaporator it is now almost all vapor. This vapor contains almost all of the refrigerant that we started with at the beginning of the tube, so the composition is almost back to 50/50. The last few remaining drops are now concentrated in the B component (about 75% in this example). The boiling point of this liquid composition is now about 50°F.

Overall Temperature Glide: The difference in temperature between the Saturated Vapor blend at the end of the evaporator and the liquid entering the evaporator is 50°F-40°F = 10°F.



Effects of Temperature Glide

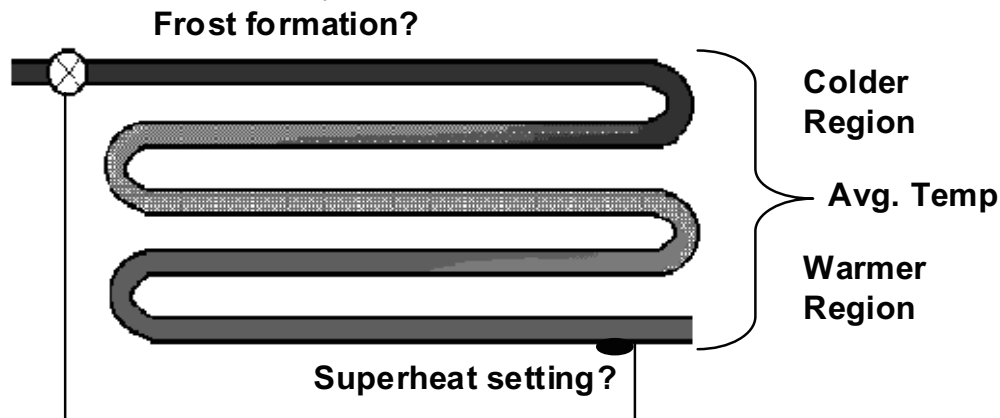

For pure refrigerants, the evaporator coil is at a constant temperature throughout. For blends, however, the temperature glide causes the tubing to be at different temperatures.

If you stand back and blow a fan across the evaporator coil, the air that blows out the other side looks like it saw an average temperature. Part of the evaporator is colder, and part is warmer, but the air mixes and generally gives the equivalent house or box temperature as if it passes over a constant temperature coil at this average. There are, however, some potential problems that can occur:

- The colder part of the coil may form frost faster than an equivalent coil at constant temp.
- The warmer part of the coil may cause "hot spots" in the case or cold box, affecting product quality.
- Temperature control sensors located in hot or cold spots may affect cycle times.
- Ice machines will produce thicker ice on the bottom of the plate and thinner ice at the top.
- TXV sensor bulbs located at the outlet of the evaporator will now see warmer gas.

Generally the temperature glide does not affect the system's ability to remove heat from the air or from product, but the glide will probably affect some of the system's controls. Superheat settings and pressure controls will be discussed further.

Frost formation and hot or cold spots must be addressed "outside" the refrigeration loop (defrost strategies, product placement, etc.). Making the whole coil warmer or colder will change the overall air or box temperature, not solve the glide-related problem.

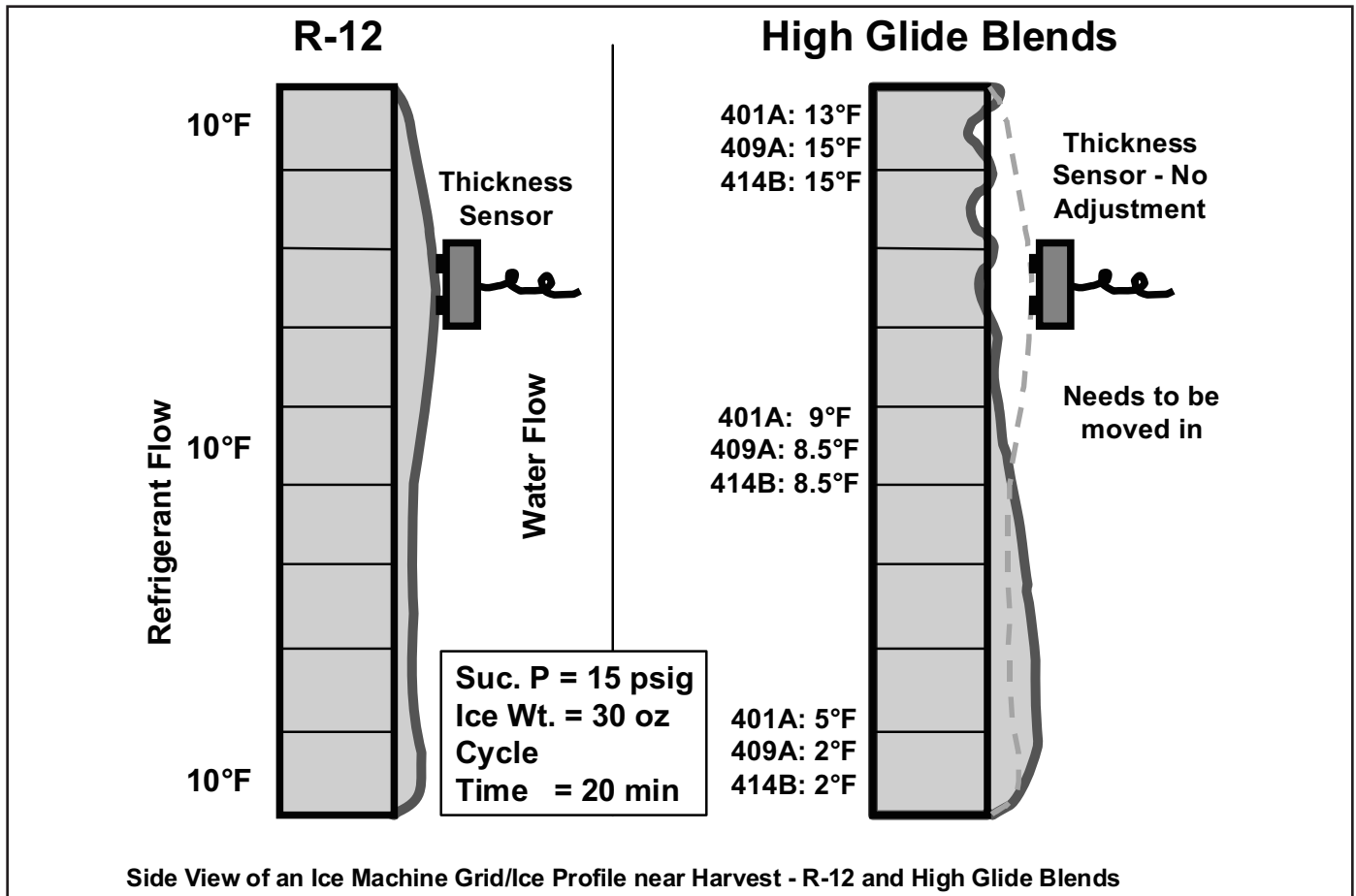

ICE MACHINE TEST RESULTS

Various R-12 retrofit blends were tested in an R-12 ice machine. The picture above represents a side-view of the plate as the water freezes.

For R-12, the water froze in a nearly constant thickness all the way down the plate. The evaporator, mounted on the back side of the plate, held a constant 10°F along the entire length. The ice thickness sensor was located at about row 3.

For each of the blends tested, R-401A, R-409A and R-414B, the glide of the blend caused the lower portion of the plate to be from 8°F to 13°F colder than the upper portion of the plate. The top rows did not fill in as quickly as the bottom, and the overall ice bank that formed was weighted more towards the lower portion of the plate.

The ice machine was still operating at the same suction pressure and was generating the same 30 ounces of ice every 20 minutes. The biggest difference was the setting of the thickness sensor. For the first run, the machine did not shut off because the ice surface near the 3rd row was not forming as fast as the lower portion of the plate. When the sensor was adjusted inward to take this into account, the machine ran fine.



Bubble Point / Dew Point

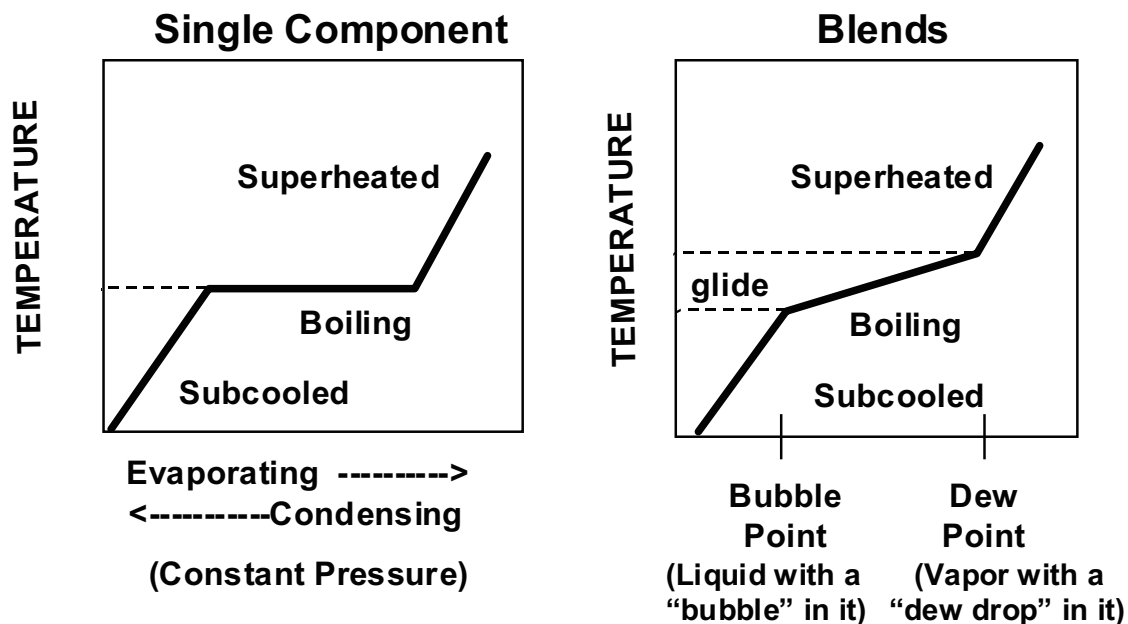

The process of phase change (boiling or condensing) is the same for blends as it is for pure refrigerants:

Boiling: liquid reaches a temperature where bubbles form and then the liquid boils to vapor. When the last drops of liquid disappear, any additional heat input causes the vapor to superheat.

Condensing: vapor cools to a temperature where liquid drops start to form, then the vapor condenses to liquid. When the last of the vapor disappears, any additional removal of heat causes the liquid to subcool.

When these phase changes occur in a pure refrigerant, at constant pressure, the temperature stays constant at what we normally call the "boiling point".

For blends the process is the same but, the shift in composition during phase change causes the temperature glide to occur. The vapor will still superheat and the liquid will still subcool; however, the Saturated Vapor temperature and the Saturated Liquid temperature are now the temperatures at the ends of the temperature glide for a given pressure.

Saturated Liquid = Bubble Point (Liquid with bubbles starting to form)

Saturated Vapor = Dew Point (Vapor with dew drops starting to form)



Two-Column PT Charts

- Traditional PT Charts
 - Temperature in left column, pressure in the remaining columns
 - Saturated pressure listed - same for boiling or condensing / saturated liquid or vapor
- New Blends Need Two Columns
 - Zeotropic blends have different temperatures for saturated liquid and saturated vapor at constant pressure
 - Bubble Point (or Liquid) gives pressure for saturated liquid; used as the reference point for subcooling calculations
 - Dew Point (or Vapor) gives pressure for saturated vapor; used as the reference point for superheat calculations

Temperature °F	°C	R22		R407C	
		Liquid Press	Vapor Press	Liquid Press	Vapor Press
-40	-40.0	0.5	3.0	4.4	4.4
-35	-37.2	2.6	5.4	0.6	0.6
-30	-34.4	4.9	8.0	1.8	1.8
-25	-31.7	7.4	10.9	4.1	4.1
-20	-28.9	10.1	14.1	6.6	6.6
-15	-26.1	13.2	17.6	9.4	9.4
-10	-23.3	16.5	21.3	12.5	12.5
-5	-20.6	20.1	25.4	15.9	15.9
0	-17.8	24.0	29.9	19.6	19.6
5	-15.0	28.2	34.7	23.6	23.6
10	-12.2	32.8	39.9	28.0	28.0
15	-9.4	37.7	45.6	32.8	32.8
20	-6.7	43.0	51.6	38.0	38.0
25	-3.9	48.8	58.2	43.6	43.6
30	-1.1	54.9	65.2	49.6	49.6
35	1.7	61.5	72.6	56.1	56.1
40	4.4	68.5	80.7	63.1	63.1
45	7.2	76.0	89.2	70.6	70.6
50	10.0	84.0	98.3	78.7	78.7
55	12.8	92.6	108	87.3	87.3
60	15.6	102	118	96.8	96.8
65	18.3	111	129	106	106
70	21.1	121	141	117	117
75	23.9	132	153	128	128
80	26.7	144	166	140	140
85	29.4	156	180	153	153
90	32.2	168	195	166	166
95	35.0	182	210	181	181
100	37.8	196	226	196	196
105	40.6	211	243	211	211
110	43.3	226	261	229	229
115	46.1	243	280	247	247
120	48.9	260	300	266	266
125	51.7	278	321	286	286
130	54.4	297	342	307	307
135	57.2	317	365	329	329
140	60.0	337	389	353	353
145	62.8	359	-	-	-
150	65.6	382	-	-	-

Pressure-Temperature (PT) charts traditionally have listed the temperature in the left column and pressures for various refrigerants in the remaining columns. For blends, we now need two columns per refrigerant: one for Vapor Pressures and one for Liquid pressures.

Note: You should not read a PT chart across - heat exchanges run at constant pressure, not constant temperature.

Superheat Setting: the process for obtaining superheat is the same as it has always been - measure the temperature on the suction line, for example, at the TXV bulb. To find the saturated vapor temperature you measure the suction pressure, and then refer to the PT chart for the corresponding temperature. For blends you must use the Vapor (Dew Point) column. Subtract the saturated temperature from the measured temperature to get the amount of superheat.

Subcooling: the process for obtaining subcooling is also the same as it has been - measure the temperature of the line at the point of interest. To find the saturated temperature of the liquid you measure the pressure on the condenser, and then refer to the PT chart for the corresponding temperature. For blends you must use the Liquid (Bubble Point) column. Subtract the measured value from the saturated value to get degrees of subcooling.

Keep in mind the state of the refrigerant (liquid or vapor) where the measurement is being taken to determine which column you need to use. Also keep in mind that the only practical place that you find saturated vapor, at the correct composition, is at the end of the evaporator when measuring superheat. **Do not use the vapor column when liquid is present, since the vapor is at the wrong composition.**



Refrigeration Example: Average Evaporator Temperature and Superheat

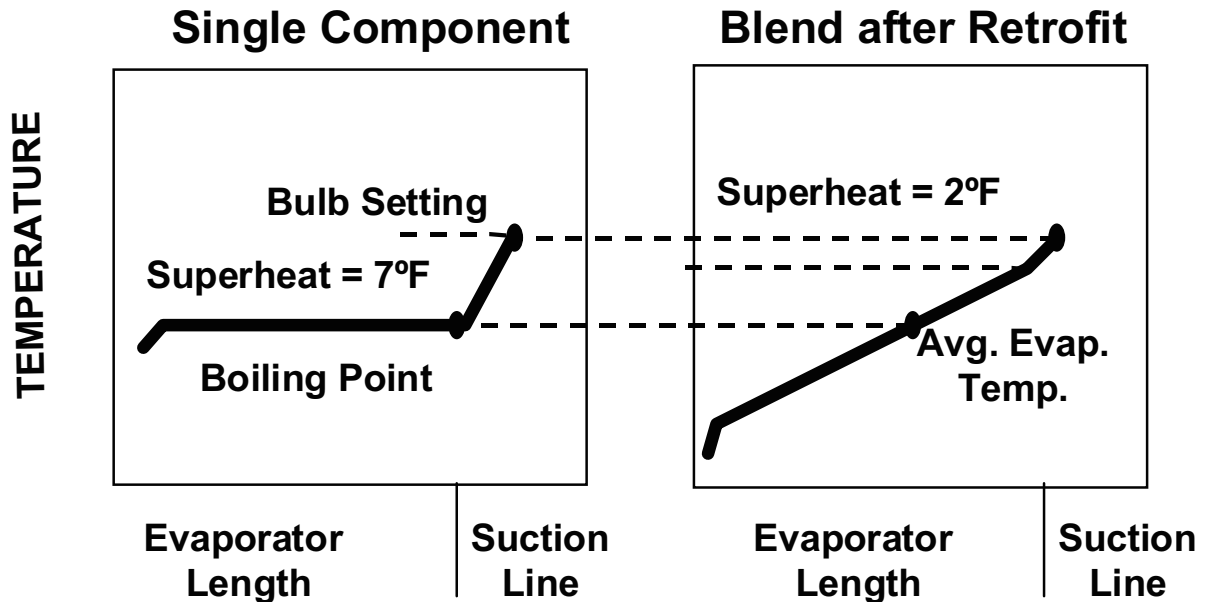

Assume a refrigeration system has been retrofitted from a single component refrigerant to a blend with a temperature glide of about 10°F. The blend will run with an average evaporator temperature that matches the constant evaporator temperature of the refrigerant that was replaced. About half of the glide is making the front of the evaporator colder, and the other half of the glide is making the back of the evaporator warmer. The outlet is about 5°F warmer than it used to be.

The TXV bulb has not been adjusted, and it was initially set for 7°F superheat above the saturated temperature of the original refrigerant. With the blend, the same average evaporator temperature is achieved - but now this only provides 2°F of superheat above the blend's vapor temperature.

If the safety margin provided by the superheat setting is reduced too far, it is possible that the refrigerant may flood back to the compressor. In many cases, reducing the superheat by 4°F or 5°F may not be a problem, but, it is always a good idea to check the superheat to make sure.

Some R-12 retrofit blends have as high as 14°F glide -- enough to completely overcome an original superheat setting of 7°F. Many of the current R-22 retrofit blends have temperature glides from 5°F to 10°F.

See pages 102 - 104 for a more detailed discussion of TXV operation after retrofitting.



Air Conditioning Example: Average Evaporator Temperature and Superheat

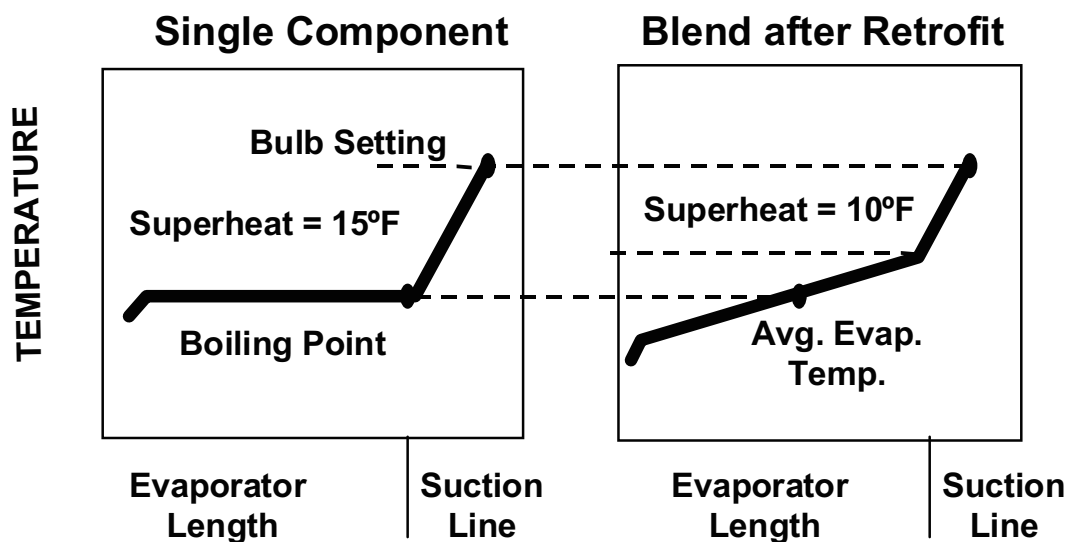

For air conditioning, the effects of temperature glide will be somewhat less severe. Using the same blend with a 10°F glide, this example looks at the effects of temperature glide using typical superheat settings for an air conditioner (10°F to 15°F).



The blend will run with an average evaporator temperature that matches the constant evaporator temperature of the refrigerant that was replaced. About half of the glide is making the front of the evaporator colder, and the other half of the glide is making the back of the evaporator warmer. The outlet will be 5°F warmer than it used to be.

The TXV bulb has not been adjusted, and it was initially set for 15°F superheat above the saturated temperature of the original refrigerant. With the blend, the same average evaporator temperature is achieved - but now the superheat drops to 10°F.

For most running conditions this should not be an immediate problem; however, air conditioners are critically charged to cover the worst case scenario of a hot day and cool house. In this case, the refrigerant is in danger of flooding back from the evaporator so correct superheat settings will be important. If the valve is adjustable, then superheat should be increased to compensate for the glide. If not, the system should be charged with slightly less refrigerant than the indicated amount.

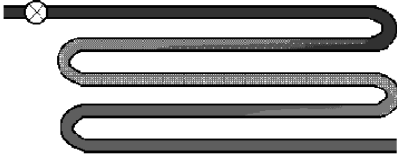

Cut In / Cut Out Pressure Control Using Blends

<p>R-12: Running System</p>  <p>Cut Out pressure=15 psig Corresponds to 10°F boiling temp</p>	<p>Blend: Running System</p>  <p>Cut Out pressure=15 psig Corresponds to 10°F avg. evap. temp</p>
<p>R-12: System is Off</p>  <p>Cut In pressure=35 psig Corresponds to 38°F "Liquid Pool" temp</p>	<p>Blend: System is Off</p>  <p>Cut In pressure=45 psig Corresponds to 38°F "Liquid Pool" temp</p>

With R-12, a Cut In/Cut Out Pressure Control work as follows:

- The R-12 coil gets down to about 10°F and the pressure is about 15 psig. This means the box temperature is somewhere in the 20's °F. The pressure switch knows the box is cold enough and it turns off the compressor.
- Liquid R-12 pools in the evaporator coil and warms up to box temperature. As the box warms to about 38°F, the R-12 in the coil generates 35 psig and the pressure switch turns the system on again.

With the R-12 Retrofit Blends, the control works similarly:

- The average blend coil temperature gets down to about 10°F at about 15 to 16 psig (depending on the blend). The box temperature is about the same as it was with R-12, and the pressure switch shuts off the system.
- LIQUID blend settles in the coil and warms to box temperature. The blends have higher liquid pressures than R-12 - if no adjustment is made, the pressure switch will kick the system back on at 35 psig. For R-401A, this happens at 29°F; for R-406A it is 32°F; for R-409A it is 27°F; for R-414B it is 28°F; and for R-416A it is 43°F. Most of the blends will turn the system on too cold, and short cycling will cause the system to freeze up.

You will need to check the liquid pressure at 38°F and reset the cut in pressure accordingly. (Note: the vapor is at the wrong composition; do not use the vapor column.)



R-12 Replacement Refrigerants Property Comparison

Refrigerant	Components	Composition	Glide	Lube	Pressure Match			
					-20	10	40	90°F
R-12	(pure)	100	0	M	0.6	14.6	37	100
R-134a	(pure)	100	0	P	4"v	12	35	104
Refrigeration Blends								
R-401A	22 / 152a / 124	53 / 13 / 34	8	MAP	1	16	41	115
R-401B	22 / 152a / 124	61 / 11 / 28	8	AP	2	19	46	124
R-409A	22 / 124 / 142b	60 / 25 / 15	13	MAP	0	15	39	116
Automotive Blends								
R-406A	22 / 600a / 142b	55 / 4 / 41	15	MAP	4"v	12	33	105
R-414B	22/600a/124/142b	50 / 1.5 / 39 / 9.5	13	MAP	0	14	37	105
R-416A	134a / 600 / 124	59 / 2 / 39	3	P	7.5"v	8	28	97

M: Mineral Oil A: Alkylbenzene P: Polyolester

R-134a: At first look, R-134a pressures match R-12 pretty well, but other properties show that R-134a needs larger equipment to perform the same job (higher compressor displacement and more surface area in the condenser). In effect, R-134a in an R-12 system has lower capacity and higher discharge pressures than expected. In addition, it requires POE flushing to remove mineral oil during a retrofit.

R-401A and R-401B: These are R22 based blends that tend to have higher temperature glide. The presence of R-152a, an HFC, hurts miscibility with mineral oil. It is recommended to change some of the mineral oil to alkylbenzene unless it is a hermetic system running at warmer temperatures. R-401A matches R-12 capacity at around 20°F evaporator; warmer conditions will begin to show effects from being over-capacity (higher amperage draw, shorter cycle times). R-401B offers a boost in capacity at lower temperatures (-30°F).

R-409A: This R-22 based-blend has higher temperature glide. It has moderate miscibility with mineral oil, and generally offers good oil return in systems down to 0°F evaporator. R-12 capacity match is about 10°F and it still works well at lower evaporator temperatures. Higher discharge temperatures and pressures can develop, especially in warmer applications.

R-414B: This R-22 based blend has been formulated to keep the head pressure down. It is approved for automotive applications, although nylon barrier hoses and special fittings are required. In refrigeration equipment there may be a drop in capacity at colder temperatures.

R-416A : This R-134a based blend has an added HCFC component that keeps the head pressure lower upon retrofit. There will be a drop in capacity compared to R-12, which could be significant in colder applications. Lower suction pressures must also be taken into account. This blend also has lower temperature glide. The manufacturer claims it is OK to use with mineral oil, however the blend does not actually mix with the oil (return is helped by a hydrocarbon component.) Adding POE lubricant is recommended for more complicated piping arrangements.



R-22 Replacements for Refrigeration and Air Conditioning

Refrigerant	Components	Glide	Lube	Pressure Match				
				-20	10	40	110	130°F
R-22	22	0	MA	10	33	68	226	279
Look-alike Blends								
R-407A	32 / 125 / 134a	10	p	12	37	78	259	34
R-407C	32 / 125 / 134a	10	p	10	34	71	245	324
R-422B	125 / 134a / 600a	5	MAP?	8	30	65	221	292
R422D	125 / 134a / 600a	5	MAP?	10	34	71	238	313
R-404A(507)	125 / 143a / 134a	1.5	P	16	44	86	271	355
R-422C	125 / 134a / 600a	4.5	MAP?	16	43	86	273	356
New Only								
R-410A	32 / 125	0.2	P	27	62	118	365	476

M: Mineral Oil A: Alkylbenzene P: Polyolester

R-407A and R-407C: Both products have the closest capacity and run-time property match to R-22. All products will have lower discharge temperatures than R-22. R-407A is a closer match at lower application temperatures, such as in commercial refrigeration applications. R-407C will work better in medium temperature and air conditioning applications. Replacement of mineral oil with polyolester (POE) is recommended

R-422B and R-422D: These blends will have lower capacity than R-22 in the same system, and in many cases there will be an increase in pressure drop that may require changing TXVs or distributors. They contain hydrocarbons that will help circulate mineral oil in smaller systems. Larger systems, especially ones with receivers, will need addition of POE to help keep the mineral oil from being stranded.

R-404A and R-507: These blends can be used to retrofit R-22 systems that would otherwise be able to run R-404A, such as in commercial refrigeration applications. TXVs would need to be changed to the appropriate R-404A model. Discharge pressures would also increase, although discharge temperatures would come down. An oil change to POE is also required.

R-422C: This blend can be used to retrofit low temperature R-22 systems. The performance characteristics (pressure/temperature) will look much like R-404A, but with a drop in capacity of up to 10%. The hydrocarbon additive will help circulate mineral oil around the system. In larger systems, however, some oil holdup may occur in the receiver. Addition of POE will solve this problem.



R-502 Replacement Refrigerants Property Comparison

Refrigerant	Components	Composition	Glide	Lube	Pressure Match			
					-20	10	40	90°F
R-502	22 / 115	49 / 51	0	MA	15	41	81	187
<u>HCFC Blends</u>								
R-402A	125 / 290 / 22	60 / 2 / 38	2.5	M+AP	19	48	93	215
R-402B	125 / 290 / 22	38 / 2 / 60	2.5	M+AP	15	42	83	198
R-408A	125 / 143a / 22	7 / 46 / 47	1	M+AP	14	38	77	186
<u>HFC Blends</u>								
R-404A	125 / 143a / 134a	44 / 52 / 4	1.5	P	16	48	84	202
R-507	125 / 143a	50 / 50	0	P	18	46	89	210
R-422C	125 / 134a / 600a	82 / 15 / 3	5	MAP	18	44	87	205

M: Mineral Oil

A: Alkylbenzene

P: Polyolester

R-402A and R-402B: R-402A shows higher discharge pressures than R-502, however the discharge temperature is lower. R-402B is a closer match in pressure, but the discharge temperature runs higher (this is good for ice machines, which is where R-402B is primarily used). Although propane is added to improve oil circulation, it is still recommended to replace some mineral oil with alkylbenzene oil.

R-408A: R-408A has the closest PT match to R-502 across the whole application range. It also has very low temperature glide. R-408A does generate higher discharge temperatures than R-502, and this could be a problem in extreme application conditions, such as transport refrigeration in hot climates. R-408A can be used in most refrigeration systems.

R-404A and R-507: These two blends are virtually the same in terms of operation and equipment. In a retrofit situation, they will require POE flushing to be performed. They will also generate higher discharge pressures. Generally speaking, retrofitting with these HCFC blends will add more complexity and cost to a retrofit job, especially when compared to using one of the other blends.

R-422C: This blend can be used to retrofit low temperature R-22 systems. The performance characteristics (pressure/temperature) will look much like R404A, but with a drop in capacity of up to 10%. The hydrocarbon additive will help circulate mineral oil around the system. In larger systems, however, some oil holdup may occur in the receiver. Addition of POE oil will solve this problem.