

SET FREE SERIES FSN2



Technical Catalogue

Outdoor Units: RAS-(8~48)FSN2

HITACHI

Inspire the Next

Specifications in this manual are subject to change without notice in order that
HITACHI may bring the latest innovations to their customers.

Whilst every effort is made to ensure that all specifications are correct, printing errors
are beyond Hitachi's control; Hitachi cannot be held responsible for these errors.

Features and benefits of SET FREE FSN2	1
General data	2
Dimensional data	3
Capacities and selection data	4
Working range	5
Refrigerant cycle	6
Piping and refrigerant load	7
Electrical data	8
Electrical wiring	9
Available optional functions	10
Troubleshooting	11

Contents (Cont.)

1. Features and benefits of SET FREE FSN2	23
1.1. Choice benefits.....	24
1.1.1. A wide range of choice.....	24
1.1.2. Flexibility of the system.....	25
1.1.3. Complete remote control range.....	26
1.1.4. Availability of Hi-Tool Kit selection software.....	30
1.1.5. Environmental design.....	30
1.2. Installation benefits.....	31
1.2.1. Expanded installation flexibility.....	31
1.2.2. Easy and Flexible Electrical Installation.....	34
1.2.3. Easy and Flexible Control Connection(Central Station, Interficie BMS, CSNET WEB).....	36
1.3. Start-up Benefits.....	36
1.3.1. Automatic Start-up Test.....	36
1.3.2. Service check.....	37
1.4. Functional Benefits.....	37
1.4.1. High Efficiency.....	37
1.4.2. Energy Saving.....	38
1.4.3. New functions.....	41
1.4.4. Temperature Range.....	43
1.4.5. Precise control with the wide range inverter.....	43
1.4.6. Multiple capacity control.....	43
1.4.7. Electronic capacity control.....	44
1.4.8. Individual operation at minimum 0.8 HP indoor unit.....	44
1.4.9. Drying operation control.....	44
1.4.10. Silent Compressor.....	45
1.4.11. Silent fan.....	45
1.5. Maintenance benefits.....	46
1.5.1. High reliability.....	46
1.5.2. Easy maintenance.....	46
1.5.3. Availability of Maintenance Tools.....	46
1.6. Main features of the units.....	47
1.6.1. Complementary Systems.....	53
2. General Data	59
2.1. General Data for RAS-FSN2 units.....	60
2.1.1. General data for RAS-8~12FSN2.....	60
2.1.2. General data for RAS-14~24FSN2.....	61
2.1.3. General data for RAS-26~42FSN2.....	62
2.1.4. General data for RAS-44~48FSN2.....	64
2.2. Component data for RAS-FSN2 units.....	65
2.2.1. Fan and heat exchanger of RAS-8~12FSN2.....	65
2.2.2. Fan and heat exchanger of RAS-14~24FSN2.....	65
2.2.3. Fan and heat exchanger of RAS-26~32FSN2.....	66
2.2.4. Fan and heat exchanger of RAS-34~42FSN2.....	66
2.2.5. Fan and heat exchanger of RAS-44~48FSN2.....	67

Contents (Cont.)

2.3. Component data for compressor	67
3. Dimensional Data	69
3.1. Dimensional data for RAS-8~12FSN2.....	70
3.2. Dimensional data for RAS-14~24FSN2.....	71
3.3. Dimensional data for RAS-26~42FSN2.....	72
3.4. Dimensional data for RAS-44~48FSN2.....	73
4.Capacities and Selection Data	75
4.1. Selection guide	76
4.2. Outdoor unit capacity with total horsepower of combined indoor unit	80
4.3. Capacity characteristic curve.....	106
4.4.Nominal cooling capacity tables (100% combination)	117
4.5. Nominal heating capacity tables (100% combination).....	121
4.6.Correction factors	128
4.6.1. Piping length correction factor.....	128
4.6.2. Defrost correction factor.....	130
4.7. Sensible heat factor (SHF)	131
4.8. Sound data	132
5. Working Range.....	139
5.1. Power Supply	140
5.2. Temperature range	140
6. Refrigerant Cycle.....	141
6.1. Refrigerant cycle for RAS-8~12FSN2	142
6.2. Refrigerant cycle for RAS-14~16FSN2	143
6.3. Refrigerant cycle for RAS-18~20FSN2	144
6.4. Refrigerant cycle for RAS-22~24FSN2	145
6.5. Refrigerant cycle for RAS-26~28FSN2	146
6.6. Refrigerant cycle for RAS-30~36FSN2	147
6.7. Refrigerant cycle for RAS-38~42FSN2	148
6.8. Refrigerant cycle for RAS-44~48FSN2	149

Contents (Cont.)

7. Piping and Refrigerant Load	151
7.1. Refrigerant piping selection.....	152
7.1.1. Minimum and maximum number of indoor units per outdoor unit.....	152
7.1.2. Refrigerant piping range.....	153
7.1.3. Refrigerant piping length by dip switch setting.....	153
7.1.4. Piping size and multiple connections kit.....	154
7.2. Multi-kits and distributors.....	156
7.2.1. Size data.....	156
7.2.2. Distribution method.....	158
7.2.3. Copper pipes and sizes.....	161
7.3. Amount refrigerant charge.....	163
7.3.1. Additional refrigerant charge calculation (R410A).....	163
7.3.2. Samples.....	165
7.4. Caution on refrigerant leakage.....	172
7.4.1. Maximum permissible concentration of HCFC/HFC gas.....	172
7.4.2. Calculation of refrigerant concentration.....	172
7.4.3. Countermeasure for refrigerant leakage.....	173
8. Electrical Data	175
8.1. Indoor Units.....	176
8.2. Outdoor Units RAS-8~48FSN2.....	177
9. Electrical Wiring	179
9.1. General Check.....	180
9.2. Setting and Function of DIP Switches for RAS-FSN2.....	181
9.3. Common Wiring.....	185
9.3.1. Electrical wiring between indoor and outdoor units.....	185
9.4. Wiring Size.....	186
10. Optional Functions Available	189
10.1. Optional Functions Available for Outdoor Units.....	190
11. Troubleshooting	191
11.1. Alarm Code.....	192



0

◆ Unit code list

i NOTE:

MODEL CODIFICATION Please check by model name your air conditioner type, its abbreviation and reference number in this technical catalogue.

FSN(2)(E) INDOOR UNITS							
4-Way Cassette		4-Way Mini Cassette		2-Way Cassette		Ceiling	
Unit	Code	Unit	Code	Unit	Code	Unit	Code
RCI-1.0FSN2E	7E400001	RCIM-1.0FSN2	60278011	RCD-1.0FSN2	60278029		
RCI-1.5FSN2E	7E400002	RCIM-1.5FSN2	60278013	RCD-1.5FSN2	60278030		
RCI-2.0FSN2E	7E400003	RCIM-2.0FSN2	60278014	RCD-2.0FSN2	60278031	RPC-2.0FSNE	7E440003
RCI-2.5FSN2E	7E400004			RCD-2.5FSN2	60278032	RPC-2.5FSN2E	7E440004
RCI-3.0FSN2E	7E400005			RCD-3.0FSN2	60278033	RPC-3.0FSN2E	7E440005
RCI-4.0FSN2E	7E400007			RCD-4.0FSN2	60278034	RPC-4.0FSN2E	7E440007
RCI-5.0FSN2E	7E400008			RCD-5.0FSN2	60278035	RPC-5.0FSN2E	7E440008
RCI-6.0FSN2E	7E400009					RPC-6.0FSN2E	7E440009

			
RCI	RCIM	RCD	RPC

☀️ ❄️ 1~

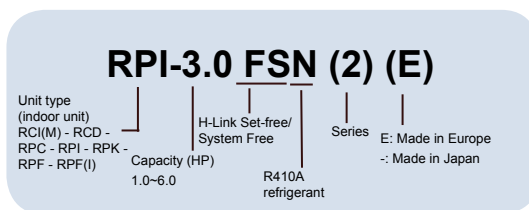

FSN(2)(E) INDOOR UNITS

Duct		Wall		Floor Enclosure		Floor Concealed Enclosure			
Unit	Code	Unit	Code	Unit	Code	Unit	Code		
				RPK-1.0FSNH2M	60277942				
RPI-0.8FSN2E	7E420000	RPIM-0.8FSN2E	7E430000	RPK-1.5FSNH2M	60277942				
RPI-1.0FSN2E	7E420001	RPIM-1.0FSN2E	7E430001	RPK-1.0FSN2M	60277941	RPF-1.0FSN2E	7E450001	RPFI-1.0FSN2E	7E460001
RPI-1.5FSN2E	7E420002	RPIM-1.5FSN2E	7E430002	RPK-1.5FSN2M	60277942	RPF-1.5FSN2E	7E450002	RPFI-1.5FSN2E	7E460002
RPI-2.0FSN2E	7E420003			RPK-2.0FSN2M	60277943	RPF-2.0FSN2E	7E450003	RPFI-2.0FSN2E	7E460003
RPI-2.5FSN2E	7E420004			RPK-2.5FSN2M	60277944	RPF-2.5FSN2E	7E450004	RPFI-2.5FSN2E	7E460004
RPI-3.0FSN2E	7E420005			RPK-3.0FSN2M	60277945	-	-	-	-
RPI-4.0FSN2E	7E420007			RPK-4.0FSN2M	60277946				
RPI-5.0FSN2E	7E420008								
RPI-6.0FSN2E	7E420009								
RPI-8.0FSN2E	7E420010								
RPI-10.0FSN2E	7E420011								



RPI

RPIM

RPK

RPF

RPFI



RPF-2.0 FSN (2) (E)

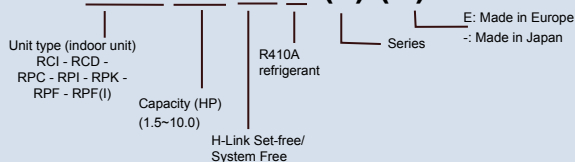

FSN2 OUTDOOR UNITS							
Unit	Code	Unit	Code	Unit	Code	Unit	Code
RAS-8FSN2	60288134						
RAS-10FSN2	60288135						
RAS-12FSN2	60288136						
		RAS-14FSN2	60288137				
		RAS-16FSN2	60288138				
		RAS-18FSN2	60288139				
		RAS-20FSN2	60288140				
		RAS-22FSN2	60288141				
		RAS-24FSN2	60288142				
				RAS-26FSN2	60288143		
				RAS-28FSN2	60288144		
				RAS-30FSN2	60288145		
				RAS-32FSN2	60288146		
				RAS-34FSN2	60288147		
				RAS-36FSN2	60288148		
				RAS-38FSN2	60288149		
				RAS-40FSN2	60288150		
				RAS-42FSN2	60288151		
						RAS-44FSN2	60288152
						RAS-46FSN2	60288153
						RAS-48FSN2	60288154



RAS

❄️ 🔥 3~

◆ Example description of a code:

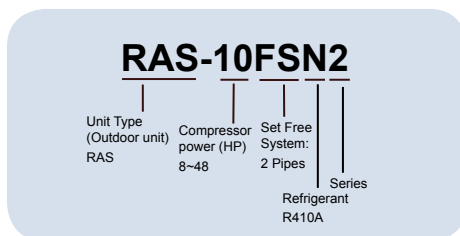

◆ Complementary systems

Name	Description	Code	Figure
KPI-502E1E	Energy recovery ventilation units	70600001	
KPI-802E1E		70600002	
KPI-1002E1E		70600003	
KPI-1502E1E		70600004	
KPI-2002E1E		70600005	
KPI-3002H1E		70600107	
EF-5NE	Econofresh kit	7E774148	

◆ List of accessories

Name	Description	Code	Figure
PC-ART	Remote control switch with timer	70510000	
PSC-A64S	Central control	60291479	
PSC-A16RS	Centralized ON/OFF controller	60291484	
PSC-A1T	Programmable timer	60291482	

Name	Description	Code	Figure
PC-LH3A	Wireless remote control switch	60291056	
PC-ARH	Optional remote controller	60291486	
PC-ALH	Receiver kit (for RCI-FSN2E -on the panel-)	60291464	
PC-ALHD	Receiver kit (for RCD-FSN2 -on the panel-)	60291467	
PC-ALHZ	Receiver kit (for RCI, RCD, RPC, RPI, RPK, RPF(I) - (FSN2(E)) -on the wall-)	60291473	
PC-ALHC	Receiver kit (for RCIM-FSN2 -on the panel-)	60291476	Image not available
PSC-5HR	H-LINK relay	60291105	
PCC-1A	Optional function connector	60199286	
PRC-10E1	2-pin extension cord	7E790211	
PRC-15E1	2-pin extension cord	7E790212	
PRC-20E1	2-pin extension cord	7E790213	
PRC-30E1	2-pin extension cord	7E790214	
THM-R2AE	Remote temperature sensor (THM4)	7E299907	
HC-A32MB	Building Management System Gateway to MODBUS systems.	7E513200 NEW	
HC-A16KNX	Building Management System Gateway to KNX systems.	7E513300 NEW	
HARC-BXE (A)	Building Management System Gateway to LONWORKS systems. (max. 64 IU, 8 parameters)	60290874	
HARC-BXE (B)	Building Management System Gateway to LONWORKS systems. (max. 32 IU, 16 parameters)	60290875	

Name	Description	Code	Figure
HC-A64BNP	Building Management System Gateway to BAC Net system.	60291569	
CSNET-WEB (v3)	Control System	7E891938	
TS001 WEB SCREEN	15-inch touch-screen display	7E891935	
PC-A-110	Integration of teams into H-LINK	7E519000	
HC-A160SMS	SMS alarm warning device	7E519100	
DBS-26	Drain discharge connection	60299192	
P-N23WA	Air panel for RCI-FSN2E	70530000	
P-N23WAM	Air panel for RCIM-FSN2E	60197160	
P-N23DWA	Air panel for RCD-FSN2E	60291574	
P-N46DWA	Air panel for RCD-FSN2E	60291575	
B-23H4	Adapter for deodorant filter	60199790	

Name	Description	Code	Figure
F-23L4-K	Antibacteria filter	60199791	
F-23L4-D	Deodorant filter	60199793	
F-46L4-D	Deodorant filter	60199794	
PDF-23C3	Duct connection flange	60199795	
PDF-46C3	Duct connection flange	60199796	
OACI-232	Fresh-air intake kit	60199797	
PD-75	Fresh-air intake kit	60199798	
PI-23LS5	3-way outlet parts	60199799	
TKCI-232	T-duct connecting kit	60199801	
MW-102AN	Branch pipe	70522001	
MW-162AN		70522002	
MW-242AN		70522004	
MW-302AN		70522005	
MH-84AN	Header	70522007	
MH-108AN		70522008	
HR-500	Energy exchanger for KPI (heat recovery)	70550101	
HR-800		70550102	
HR-1000		70550103	
HR-1500		70550104	
HR-2000		70550105	

Name	Description	Code	Figure
STL-30-200-L600	Sound attenuator (Heat/energy recovery)	70550200	
STL-30-250-L600		70550201	
STL-30-300-L600		70550202	
STL-30-355-L600		70550203	
STL-30-450-L600		70550204	

0

Introduction

◆ System description

- The SET FREE air conditioning system is a VRF (Variant Refrigerant Flow) type system that allows multiple indoor units, of different power and model, to be set up with independent control for each of them.
- The Hitachi SET FREE systems offer high efficiency, reliability and comfort, features that make the SET FREE system one of the best on the market.

◆ Benefits of the system

- HITACHI proudly introduces the new SET FREE FSN2 series, the highly-efficient and reliable air conditioning system. Recently, increased numbers of buildings are requiring "Intelligent" facilities communication networks, office automation, including a comfortable environment. Particularly, comfortable space is required all the day through the year in office buildings. This multi-split system air conditioner, SET FREE can meet these requirements. The proper combination of the scroll compressor and the inverter provides the best air conditioning for small/medium office buildings.
- The SET FREE air conditioning system incorporates a set of technical benefits that make it one of the most attractive on the market.
- Right from the selection of the ideal type of equipment in each case, up to it's maintenance, and through installation, start up and operation. SET FREE always provides the best solution for every user, and greatly simplifies and eases the user's selection process.

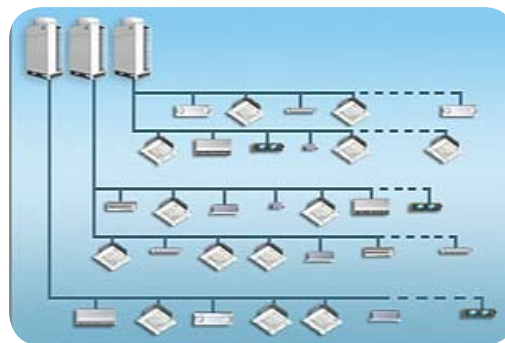

Diagram showing the multiple combinations of a SET FREE FSN2 system

- HITACHI offers the same type of indoor unit, the SYSTEM FREE system. Until now each range of outdoor units had its own indoor units. SYSTEM FREE allows users to design a system without having to think what kind of indoor units are needed for it.
- Another benefit of this system is that it allows better stock control and optimizes the number of references. Thanks to this, both installers and distributors obtain a significant reduction in stock and storage costs.

◆ Advantages of SET FREE FSN2 Series

- **Energy Saving**
Thanks to Hitachi's unique energy-saving technology such as the high-efficiency DC inverter compressor, industry-leading COP has been achieved.
- **Easy Installation**
Integrated compact design for all models of outdoor units. Simplifies installation and increases the flexibility of location. In addition, the maximum piping length was extended from 300m to 1,000m, further improving flexibility in design.
- **Wide Product Range**
4 types and 21 models of outdoor units 7 types and 39 models of indoor units
- **Comfort**
Fine temperature setting and noise reduction technology for comfortable air conditioning.
- **Reliability**
Hitachi's long scroll compressor experience ensures greater reliability.
- **Control by Network System with the H-LINK II system:**
The number of connectable indoor units is significantly increased. Workability is drastically improved. Functionality is greatly enhanced.

◆ **Environmentally-friendly**

– A comfortable air-conditioned environment is essential in buildings which are part of a comfortable urban space. Air conditioning systems for buildings are required to meet various needs such as “consideration for the global environment”, “lower energy consumption”, “lighter installation work”, and “smaller footprint”. Hitachi’s new multi-split air conditioning system for buildings, the SET FREE FSN2, can meet such needs on a high level. Based on cutting edge technologies, a rich portfolio, a diversity of options and comprehensive services that only Hitachi can provide, we will offer a comfortable air-conditioned environment in accordance with the characteristics and functions of the building. The concept of the Hitachi SET FREE series is to provide buildings with high-quality, high-value-added air conditioning systems.

– They use R410A refrigerant.

Hitachi units are environmentally-friendly because they use R410A refrigerant, while the RoHS and green dot regulations are applied in their assembly process, showing Hitachi to be highly aware and respectful of the environment.

R410A is totally environmentally-friendly since it does not contain any substances that are harmful to the ozone layer, ODP (Ozone Depleting Product) = 0.

– This new model adopts only one inverter compressor circuit in all models (from 8 to 48HP units), so that the generation of higher harmonic wave is constant regardless of the unit capacity.

This is really environment-conscious product.



Refrigerant

HITACHI integrated unit

Module unit

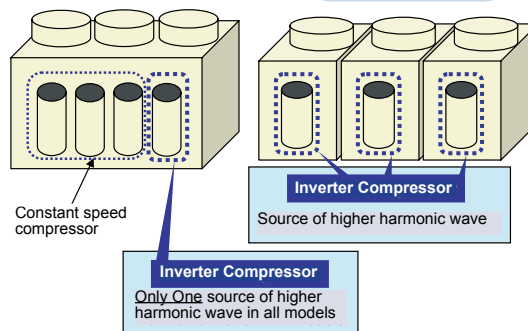

Hitachi large capacity units achieved reduction of higher harmonic wave generation by incorporating the constant speed compressor

Comparison of higher harmonic wave generation

	10HP	20HP	48HP
Hitachi integrated unit	100%	45%	20%
Module unit (10HP x N units)	100%	100%	100%

- High energy efficiency

HITACHI's units FSN2 are very efficient and permit significant savings in energy when compared with the conventional systems. This energy efficiency means that less CO₂, which causes the greenhouse effect, is produced.

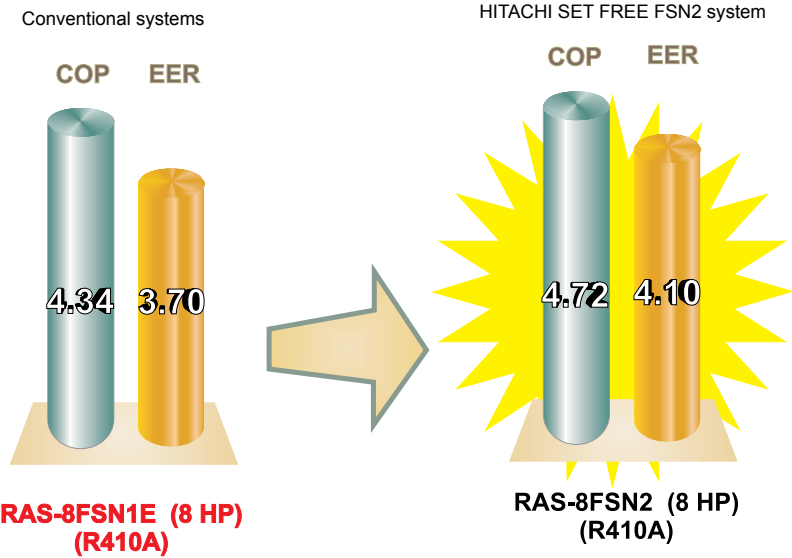

The industry-leading COP is achieved by the following new technologies:

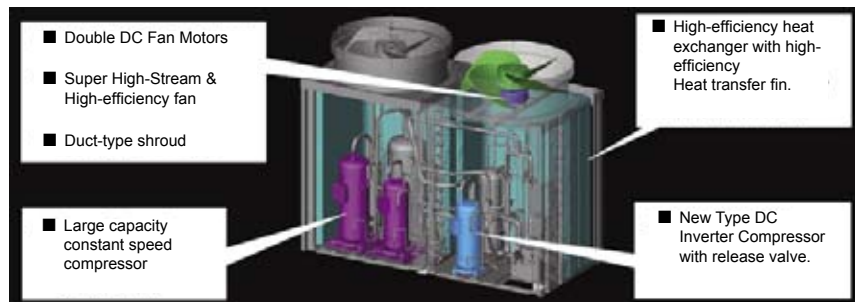

1. Features and Benefits of SET FREE FSN2

This chapter describes the features and benefits of the SET FREE FSN2 series outdoor unit. The system's flexibility and integrated design offer you the complete solution for your air conditioning requirements.

1

Contenido

1. Features and benefits of SET FREE FSN2	23
1.1. Choice benefits	24
1.1.1. A wide range of choice	24
1.1.2. Flexibility of the system	25
1.1.3. Complete remote control range.....	26
1.1.4. Availability of Hi-Tool Kit selection software	30
1.1.5. Environmental design.....	30
1.2. Installation benefits	31
1.2.1. Expanded installation flexibility	31
1.2.2. Easy and Flexible Electrical Installation	34
1.2.3. Easy and Flexible Control Connection(Central Station, Interficie BMS, CSNET WEB).....	36
1.3. Start-up Benefits	36
1.3.1. Automatic Start-up Test.....	36
1.3.2. Service check.....	37
1.4. Functional Benefits	37
1.4.1. High Efficiency	37
1.4.2. Energy Saving.....	38
1.4.3. New functions.....	41
1.4.4. Temperature Range	43
1.4.5. Precise control with the wide range inverter	43
1.4.6. Multiple capacity control.....	43
1.4.7. Electronic capacity control	44
1.4.8. Individual operation at minimum 0.8 HP indoor unit.....	44
1.4.9. Drying operation control	44
1.4.10. Silent Compressor.....	45
1.4.11. Silent fan	45
1.5. Maintenance benefits	46
1.5.1. High reliability.....	46
1.5.2. Easy maintenance.....	46
1.5.3. Availability of Maintenance Tools	46
1.6. Main features of the units	47
1.6.1. Complementary Systems	53

 Choice benefits:



1.1. Choice benefits

1.1.1.A wide range of choice

- ◆ Wide product range of outdoor units

Space, structure, and necessary functions. In line with evolving in building design, the requirements for air conditioning have also diversified.

HITACHI SET FREE FSN2 Series offers 4 types of all-in-one outdoor units. By combining units from a wide selection of models, you can create a custom air conditioning environment to satisfy your specific building conditions.

Outdoor Units	Capacity (HP)																					
	8	10	12	14	16	18	20	22	24	26	28	30	32	34	36	38	40	42	44	46	48	
	●	●	●																			
				●	●	●	●	●	●													
										●	●	●	●	●	●	●	●	●				
																				●	●	●

HITACHI

HITACHI label of the
SET FREE FSN2
Series

Choice benefits:



◆ **Various indoor units and combinations**

The line-up of new SET FREE FSN2 series indoor units has been extended up to 52 indoor units in 11 types to meet various building requirements (0.8 to 10 HP)

Indoor Units		Capacity (HP)										
		0.8	1.0	1.5	2	2.5	3	4	5	6	8	10
Duct		●	●	●								
					●	●	●	●	●	●		
											●	●
Duct for hotels		●	●	●								
Cassette	4-way		●	●	●							
			●	●	●	●	●	●	●	●		
	2-way		●	●	●	●	●	●	●			
Wall			●	●	●	●	●	●				
Ceiling					●	●	●	●	●	●		
Floor	With casing		●	●	●	●						
	Without casing		●	●	●	●						

1.1.2. Flexibility of the system

◆ **Large variety of options in the standard commands**

SET FREE units have a great number of standard commands. These options can be easily configured by means of any of the wide variety of HITACHI remote-control switches, or through the PCBs of the indoor and outdoor units. In this way the SET FREE system adapts to each installation.

◆ **Variable installation capacity**

Utilizing an inverter control, a wide range of operation capacity control is also available.

Thanks to this, it can adapt to the requirements of each installation according to the power needed at each moment.

With this feature of the SET FREE system, an installation can be expanded, taking into account that you can install indoor units with a capacity of up to 130% of the outdoor capacity, or reduced up to 50% of the outdoor capacity.

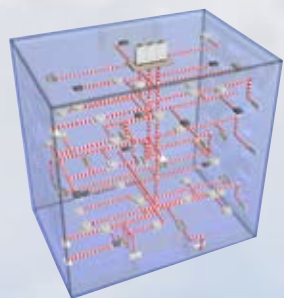

1

☞ Choice benefits:

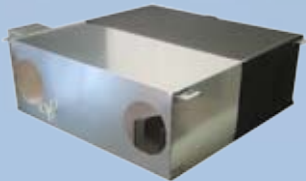

KPI



Econofresh

◆ **A wide range of accessories**

All the units have a large set of accessories that facilitate installation, operation and maintenance.

These accessories are designed to improve and adapt the unit to the type of installation the system needs, always keeping in mind the parameters of quality that the system requires.

These accessories are of type:

- Remote control switches
- Panels
- Filters
- Multikits

◆ **Wide range of complementary systems**

The complementary systems have been designed as elements attached to the installation. They improve its performance in terms of power consumption and the quality of the conditioned air.

◆ **KPI**

Energy recovery unit with two choice options, depending on the installation requirements:

- Heat recovery units, which recover the energy through the temperature.
- Energy recovery units, which recover the energy through the temperature and humidity.
- Wide range of capacities from 500m³/h to 3.000m³/h.

◆ **Econofresh**

Air renewal unit that also permits a saving in energy. Connected to the RPI-5.0FSN2E unit.

Allows different operating modes depending on the type of installation.

1.1.3. Complete remote control range

HITACHI has three different remote control systems that can be used with DC INVERTER outdoor units.

- Individual control systems
- Centralized control systems
- Computer control systems

HITACHI also has interface equipment to integrate its machines in installations with intelligent control or BMS (Building Management System).

 Choice benefits:



PC-ART
Wall-mounted remote
control switch with timer



PC-LH3A
Wireless Remote
Control Switch



PC-ARH
Basic wired remote
control switch



PSC-A1T
Timer

◆ Individual Control Systems

◆ **PC-ART**

Remote control switch with timer:

- LCD display.
- 4 timer settings per week.
- Optional functions like locking, energy saving, and intelligent room temperature maintenance.
- Automatic testing to solve problems that provides information continually with an alarm code.
- Access to all function settings for the indoor units.
- Thermostat function available.
- Details of all settings are given on screen, facilitating system functionality checking.
- If there are problems with the power supply the backup functions keep the timer working.
- Indoor unit control groups (from 1 to 16 units in each group).

◆ **PC-LH3A**

A wireless remote control switch that removes the need for wiring and provides simple one-touch operation. Permits control of two or more units simultaneously.

◆ **PC-ARH**

Smaller remote control than conventional remote controls. Its main features are setting the unit's temperature and operating mode. It is ideal for facilities such as hotels due to its user-friendliness.

Two remote control switches or a group control (for a maximum of 16 units) can be used in a similar way to the standard remote control switch.

When a problem occurs, an alarm code immediately shows the details of the error.

There are also optional functions such as limiting the operating mode, limiting the maximum temperature in heating/cooling mode, selecting the fan speed, etc.

◆ **PSC-A1T**

Programmable timer used to set operating schedules for air conditioning systems.

Along with the PSC-A64S and PC-ART controllers, the air conditioners they control can be operated according to the schedule below:

- The timer can be set at 7-day intervals and operation/stop can be set three times a day.
- The remote control switch can be disabled during the OFF time (when used with PSC- A64S and PC-ART).
- Two types of weekly schedule (A and B) can be set and easily changed for summer and winter operation.
- Settings are all digitally displayed, allowing operations and settings to be easily checked.

The power failure backup function prevents the timer from stopping because of a power failure (even if it lasts for weeks).

1

☞ Choice benefits:



PSC-A64S
Central station



CSNET-WEB
Control System



TS001 web screen



PC-A-110



HC-A160SMS

◆ **Centralized Control Systems**

◆ **PSC-A64S** (central control)

- A group of up to 64 remote control switches can be connected to an H-LINK II to control up to 128 indoor units.
- Up to 8 PSC-A64S units can be connected to an H-LINK II.
- In addition to the basic functions, operation mode and temperature setting, it is possible to set the air flow or auto louver.
- When a problem occurs, an alarm code immediately shows the details of the error.
- A signal terminal to provide external inputs is supplied as standard which control the following functions:
 - On/Off
 - Emergency stop
 - Central operation output
 - Central alarm output

◆ **PSC-A16RS** (central control)

- Up to 16 indoor units can be connected.
- User-friendly.

◆ **Computer Control Systems**

◆ **CSNET-WEB (v3)**

HITACHI has developed the CSNET WEB system enabling equipment to be controlled remotely from any point of the local corporate network, or even via the Internet.

CSNET WEB can be connected to the H-LINK network from any point on the network using a non-polarity two-wire cable, facilitating the installation task to the maximum. 16 outdoor units and 128 indoor units can be controlled by each H-LINK.

CSNET WEB offers the following functions:

- Locking of the different setting points.
- Temperature selection.
- Cooling and heating mode selection.
- Fan speed selection.
- Monitoring of energy consumption percentage.
- Automatic cooling/heating mode.
- Annual timer.

◆ **TS001 Web screen**

Hitachi has developed a 15" touchscreen, which by using the CSNET WEB and without the need for another computer, allows the air conditioning units to be controlled, monitored and managed.

This screen is very practical for surveillance centers.

◆ **PC-A-110**

Allows non-HITACHI units (fans, air processing units, etc) to be incorporated in the H-LINK system. Therefore, specific parameters of these units can be monitored and controlled through the CSNET WEB.

HARC I&O units can regulate up to 5 signals such as fan speed control, off, on, etc.

◆ **HC-A160SMS**

SMS alarm warning device. The message contains the alarm and the unit to which it refers. This message can be sent up to 5 different numbers.

The message is repeated as a reminder until a response is sent.

 Choice benefits:

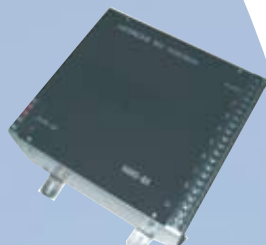

HARC BX



HARC MODBUS



HC-A64BNP

 NOTE:

For more information on the remote control switches see the TC0050 technical catalogue.

◆ Building Management Systems

◆ HARC BX

Integration with installations with intelligent control (Building Management System)

Gateway interface with LON-WORKS BMS systems (installations with intelligent control or BMS). HARC-BX allows control of up to 5 setting points and remote monitoring of up to 9 values.

Connecting the HARC-BX to an H-LINK (communication line between machines) allows the use of up to 8 coolant cycles and control of up to 64 indoor units.

The HARC-BX can be connected to any point in the H-LINK system.

◆ HARC MODBUS

Integration with installations with intelligent control (Building Management System)

Gateway Interface to MOD BUS BMS systems.

The use of HARC MOD BUS allows the unit to be remotely controlled, as well as its parameters to be monitored.

Connecting the HARC MOD BUS to an H-LINK (communication line between machines) allows the use of up to 8 coolant cycles and control of up to 64 indoor units. A maximum of 8 HARC MOD BUS can be connected to the same H-LINK.

The HARC MOD BUS can be connected to any point in the H-LINK system.

The MOD BUS systems have the advantage that the MOD BUS protocol is an open system and therefore it allows this software to be used at no cost for the user.

◆ HC-A64BNP

Integration with installations with intelligent control (Building Management System)

Gateway Interface to BAC NET BMS systems.

The use of HC-A64BNP allows the unit to be remotely controlled, and its parameters to be monitored.

Connecting the HC-A64BNP to an H-LINK (communication line between machines) allows the use of up to 8 refrigerant cycles and control of up to 64 indoor units. Up to eight HC-A64BNP can be connected to the same H-LINK.

The HC-A64BNP can be connected to any point in the H-LINK system. The advantage of the HC-A64BNP systems is that the BAC NET protocol is an open system and therefore it allows this software to be used at no cost for the user.

1

☛ Choice benefits:

1.1.4. Availability of Hi-Tool Kit selection software

Hi-Tool Kit is a tool that allows you to design installations and automatically generate all the information necessary to carry out the works. This information is:

- A table to select products.
- Coolant and electric diagram generated automatically according to the installation design.
- List of products necessary to carry out the installation.
- Start-up management.



1.1.5. Environmental design

This new model adopts only one inverter compressor circuit in all models (from 8 to 48HP units), so that the generation of higher harmonic wave is constant regardless of the unit capacity. This is really environment-conscious product.

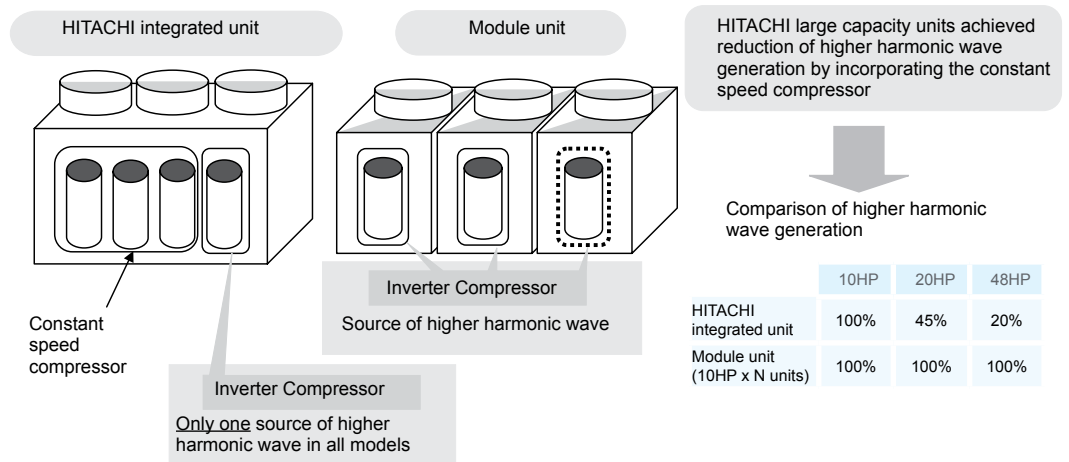

A table to select products



Coolant layout

Installation benefits:

1.2. Installation benefits

1.2.1. Expanded installation flexibility

◆ Flexible installation

The installation conditions and the number of connectable indoor units against the current models are widely improved to facilitate the flexible installation workability.

Industry-leading

Total Maximum Piping Length 300m → 1000m

Maximum Piping Length 150m → 165m
(Equivalent length 175 → 190m)

Max. Length after branch 30m → 40m

Max. Length after first branch 40m → 90m

Lift between indoor unit and outdoor unit
Outdoor unit is higher: within 50m
Outdoor unit is lower: within 40m

Lift between indoor unit max. 15m

Acceptable for large scale installation! More flexible design / Installation is available.

HP	8	10,12	14~22	24	26	28
	13	16	20	27	29	31

HP	30,32	34,36	38,40	42,44	46,48
	32	34	38	42	46

The number of connectable indoor units are improved for 34 to 48 HP outdoor units

i NOTE:

When the total piping length is over 300m, the additional refrigerant charge is required according to piping length as shown in chapter 7 "Piping and refrigerant charge".

◆ Easy Installation

HITACHI's integrated design for all outdoor unit models allows for easy installation and high reliability by minimizing piping connections.

HITACHI integrated unit

Module unit

	Wiring connection	Circuit breaker	Piping connection	
			Gas	Liquid
Integrated unit	5	1	3	1
Module unit (External connection)	15	3	1	9

Installation benefits:

NOTES:

() : Max. number of min. capacity indoor units connectable.

* Indoor unit connected capacity range : 50-130% of outdoor unit capacity.

* Secure air permeability in the event of refrigerant leakage.



Examples for RAS-10FSN2:

Multikits and distributors example supplied by HITACHI:



NOTE:

For additional information concerning the multiple connection kits that Hitachi offers, refer to chapter 7.

◆ Integrated Design Provides Transportation Time Saving (FSN2 Series)

Only one crane operation is required for installation.

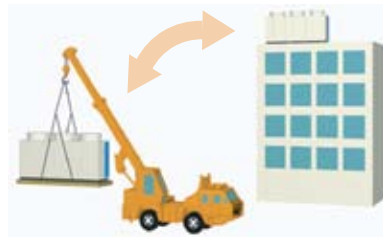

◆ Combined unit to improve capacity

As shown in the table on the right, the minimum capacity and maximum number of indoor units to be connected are increased to match the indoor load.

Outdoor unit capacity	Min. capacity of indoor units connectable	Max. number of indoor units connectable	Outdoor unit capacity	Min. capacity of indoor units connectable	Max. number of indoor units connectable
8 HP	0.8 HP	13 (8)	30 HP	0.8 HP	32 (24)
10 HP	0.8 HP	16 (8)	32 HP	0.8 HP	32 (24)
12 HP	0.8 HP	16 (8)	34 HP	0.8 HP	34 (28)
14 HP	0.8 HP	20 (12)	36 HP	0.8 HP	34 (28)
16 HP	0.8 HP	20 (12)	38 HP	0.8 HP	38 (32)
18 HP	0.8 HP	20 (16)	40 HP	0.8 HP	38 (32)
20 HP	0.8 HP	20 (16)	42 HP	0.8 HP	42 (34)
22 HP	0.8 HP	20 (16)	44 HP	0.8 HP	42 (34)
24 HP	0.8 HP	27 (20)	46 HP	0.8 HP	46 (38)
26 HP	0.8 HP	29 (20)	48 HP	0.8 HP	46 (38)
28 HP	0.8 HP	31 (24)			

◆ Flexible installation. Multikits and distributors

Hitachi's SET FREE FSN2 system provides great flexibility, accepts different types of systems, and allows up to 46 indoor units, depending on the model of the outdoor unit. The figures below show the different types of installation:



Hybrid system



System with distributor



Multikit system

Hitachi provides all the accessories required for mounting the piping system, such as multikits and distributors. Hybrid installations can be applied between multikits and distributors, which makes the installation more flexible and greatly simplifies the problems that using a rigid system can create.

Installation benefits:

◆ **Slim and compact**

In-line installation is possible due to the structure of a rear intake and upward discharge design. Even a limited space can be effectively utilized.

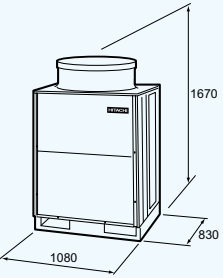
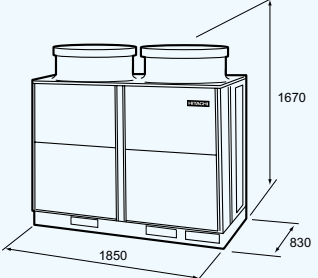
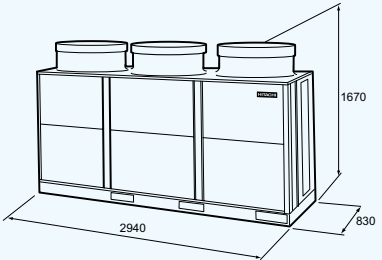
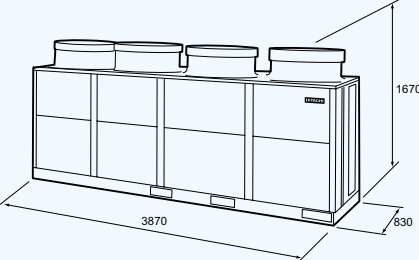
<p>RAS-8~12FSN2 Installation space: 0.90 m²</p>	<p>RAS-14~24FSN2 Installation space: 1.54 m²</p>
	
<p>RAS-26~42FSN2 Installation space: 2.44 m²</p>	<p>RAS-44~48FSN2 Installation space: 3.21 m²</p>
	

1

☛ Installation benefits:

1.2.2. Easy and Flexible Electrical Installation

◆ **Corresponding to H-LINK II System**

This SET-FREE FSN2 series outdoor units corresponds to the new H-LINK II transmission system improved from current H-LINK system. Maximum 64 refrigerant systems and maximum 160 indoor units are available to control by only one central control device when the equipments (central control device, indoor units, remote control switch) in the same transmission system are all corresponding to H-LINK II.

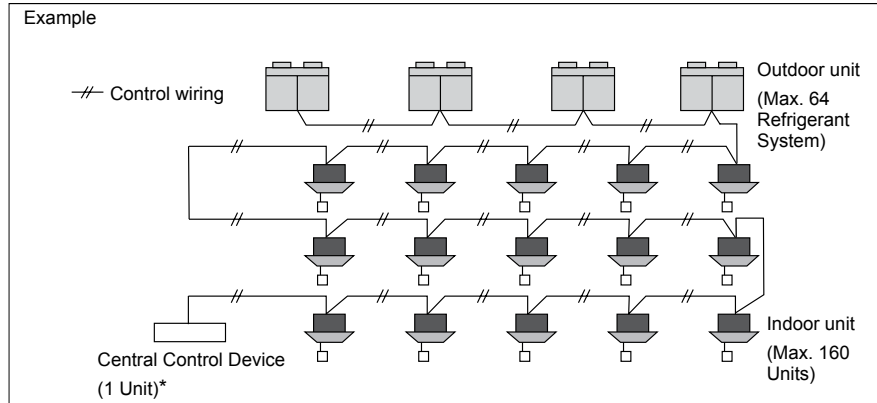

(*) The above example shows the case that central control device, indoor units and remote control switch are all corresponding to H-LINK II system

Specifications	
Transmission cable	2-wire
Polarity of transmission cable	Non-polar wire
Maximum outdoor units	64 units per system
Maximum indoor units	160 units per H-Link II system
Maximum wiring length	Total 1000 m (including CS-NET WEB) (5.000 m*)
Address setting range of indoor units	0 to 63 per outdoor unit.
Total devices quantity in the same H-LINKII	200
Recommended cable	Shielded twisted pair cable or shielded pair cable, over 0.75 mm ² (equivalent to KPEV-S)
Voltage	DC5V

(*) In case of using 4 units of PSC-5HR.

☛ Example of H-LINK system:

i NOTES:

When using the H-LINK II system, DIP switches have to be adjusted. If the DIP switches are not set or set incorrectly, an alarm may occur due to transmission failure. Total wiring length for the remote control switch can be extended to up to 5,000 m. If total wiring length less than 30 m, it is possible to use the normal wiring (0.3 mm²).

The H-LINKII system provides maximum flexibility for system design; installation is easy, and total costs are reduced. Furthermore, it can be controlled centrally by connecting CSNET WEB to H-LINK II wiring located in the room next to the room where CSNET WEB is installed.

You can also control of installation by means of the Internet via CSNET WEB

Installation benefits:

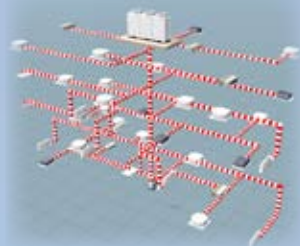

Connections layout

◆ Compare with H-LINK System

Item	H-LINK	H-LINK II
Number of Max. Ref. Group / System	16	64
Address Setting Range of Indoor Units / Ref. Group	0 to 15	0 to 63
Number of Max. Indoor Unit / System	128	160
Total Devices Q'ty in the same H-LINK	145	200
Max. Wiring Length	Total 1,000m (5,000m*)	

*: In case four units of PSC-5HR is used.

◆ The Mixture of H-LINK and H-LINK II

H-LINK II corresponding models can be mixed with H-LINK corresponding models in the same system without any adaptor.

Control System Device	Outdoor Unit Indoor Unit	One H-LINKII System	
		Outdoor Unit (Number of Ref. Group)	Indoor Unit
H-LINK II	H-LINK II	64	160
	H-LINK II / H-LINK Mixed	64 *1)	128
H-LINK	H-LINK II	16	128
	H-LINK II / H-LINK Mixed	16	128

*1) The maximum 16 refrigerant groups are available in one H-LINK system under the following conditions.

- * The outdoor unit corresponding to H-LINK
- * The outdoor unit corresponding to H-LINK II connected with the indoor unit corresponding to H-LINK.

More than 17 indoor units are available to connect with one outdoor unit depending on the outdoor unit capacity. In that case, two refrigerant groups are required for one outdoor unit.

System Configuration	Outdoor Unit: H-LINK Indoor Unit: H-LINK II and H-LINK Remote Control Switch: H-LINK II and H-LINK			Outdoor Unit: H-LINK II Indoor Unit: H-LINK II and H-LINK Remote Control Switch: H-LINK II and H-LINK		
Outdoor Unit						
Indoor Unit						
Remote Control Switch						
Setting Range of Refrigerant Group *1)	0 to 15			0 to 15		
Setting Range of Address *1)	0 to 15	0 to 15	0 to 15	0 to 15	0 to 15	0 to 63
Automatic Reset of Setting Temperature *2)	X	●	●	X	●	●
Operation Lock *2)	X	●	●	X	●	●
Limitation of Setting Temperature Range *3)	X	●	●	X	●	●
ON / OFF Timer Setting (72Hr.) *2)	X	●	●	X	●	●
Different Operation Mode Indication *3)	X	X	●	X	X	●
Indoor Unit Hot-Start Indication *3)	X	X	●	X	X	●
Change of Indoor Unit Ref. Group No. and Address *2)	X	X	●	X	X	●
Outdoor Unit Comp. Pre-heating Indication / Cancel *2)	X	X	X	X	X	●
Emergency Operation from Remote Control Switch *4)	X	X	X	X	X	●

*1) The range of ref. group setting and address setting is 0 to 15 when H-LINK corresponding central controller is used.

*2) These functions can be set by wired remote control switch (PC-ART) only.

*3) These functions can be set by wired remote control switch (PC-ART) and half size remote control switch (PC-ARH) only.

*4) This function is not available depending on the outdoor unit type.

1

Start-up benefits:



Test run from the remote control switch (PC-ART)

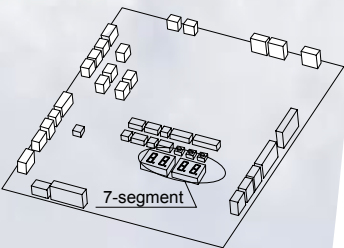

PCB for FSN2

1.2.3. Easy and Flexible Control Connection (Central Station, Interfície BMS, CSNET WEB)

◆ **No Polarity**

Thanks to the absence of polarity, any centralized control can be connected directly to the H-LINK II bus, which means that special lines are not needed.

◆ **Auto-Configuration**

Aside from the customized configuration, the control systems are also auto-configurable; for example, they have the capacity of interpreting the type of machine they are connected to, and detecting the type of indoor unit or its power.

1.3. Start-up Benefits

1.3.1. Automatic Start-up Test

◆ **Test Run**

The automatic test run can be activated through outdoor unit DIP switch or indoor unit remote control switch. The outdoor unit 7-segment display gives all the necessary information to verify the correct operation of the system.

- Connected Outdoor Units Identification system:
Using a remote control switch, you can confirm what series the operational outdoor units belong to (e.g. single or multiple).
- Automatic identification of each indoor unit.
They can also be manually assigned using the unit's DIP rotating switch.

◆ **Test Run from the Remote Control Switch**

Using the remote control, 3 operations can be run.

- Auto-diagnostic:
Quick check of the operating conditions of the indoor units and the outdoor unit.
- Data memory query:
If an abnormality occurs, the LCD remote control switch shows an alarm code and save all the operation settings of the unit at the time the fault occurs, so that a quick diagnosis can be made of the installation.
- Optional Function Setting:
The remote control switch allows cancellation of the 4-degree offset in the heating mode and an increase in the fan speed setting, among 29 possible options.
This way, multiple indoor units can be set at the same time. Also, the configuration can easily be changed, even after the installation has been completed.

◆ **Test Run Procedure from the Outdoor Unit:**

The outdoor unit PCB is equipped with a 7-segment screen, which depending on the position of the PSWs shows the following parameters in sequence

- Outdoor air temperature
- Discharge gas temperature
- Evaporation temperature in heating mode
- Condensing temperature
- Discharge pressure
- Compressor run time
- Suction pressure

This allows quick and accurate diagnosis of the installation during normal operation or test run.

Functional benefits:



HITACHI Service Tools software



NOTE:

The beside figures indicate the cooling/heating COP per outdoor unit when combined with HITACHI designated indoor unit.

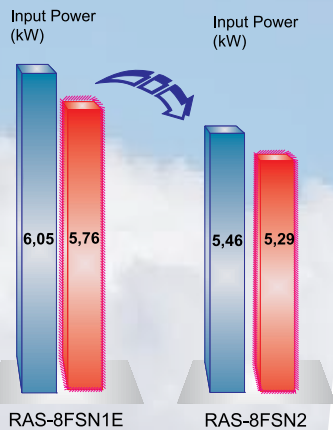

■ Cooling
■ Heating

1.3.2. Service check

◆ Hitachi Service Tools

Hitachi also has a powerful IT tool, Hitachi Service Tools. This software can be run from any lap-top computer through an interface connected to the H-LINK II bus, and it can collect several parameters that have an influence on the unit's performance. These parameters can also be monitored in different formats, allowing incidents during start-up to be located quickly.

1.4. Functional Benefits

1.4.1. High Efficiency

◆ High Efficiency (FSN2 Series)

Industry-leading COP and high efficiency operation has been realized in all outdoor unit models from 8 to 48HP of new FSN2 series. Significant cost reduction in annual electricity charges is available thanks to greatly improved operation efficiency. The next figures indicate the cooling/heating COP per Outdoor unit when combined with HITACHI designated Indoor Unit.

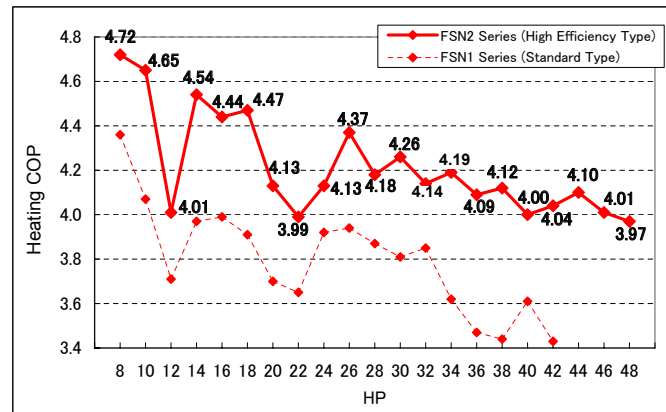
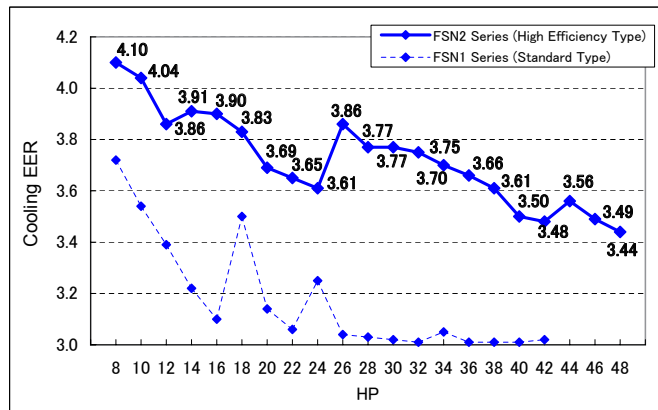

Functional benefits:

1.4.2. Energy Saving

◆ **New Type DC Inverter Scroll Compressor**

- Improved intermediate pressure performance.
The intermediate pressure performance is drastically improved by using a release valve and optimizing orbiting scroll lifting force in the improved new compression mechanism, therefore intermediate pressure performance is largely improved for energy-saving.

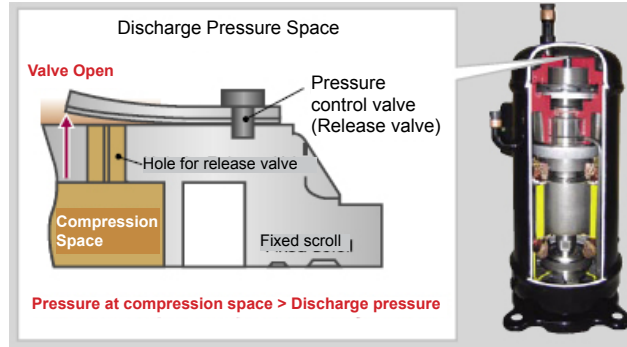

- Release valve adoption prevents from overcompression.
- Orbiting scroll lifting force optimization is Improved leakage loss reduction.

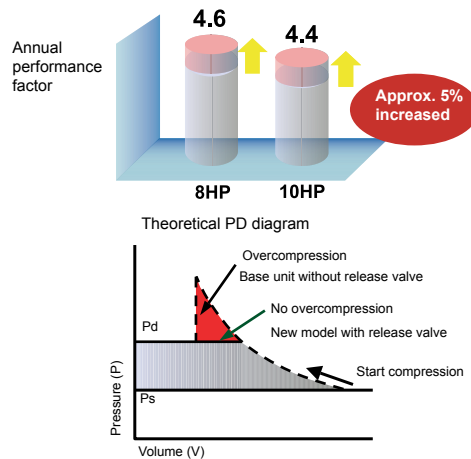

◆ **Large capacity constant speed compressor**

Large capacity constant speed compressor is equipped with over 14HP outdoor units to reduce the number of compressor.

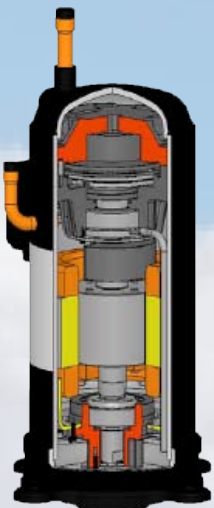

New DC Inverter scroll compressor

Functional benefits:

◆ High-efficiency heat exchanger

- Compact design and high-efficiency by arranging narrow heat exchanger tubes in 3 rows.
- Newly-developed high-efficiency heat transfer fin
- Heat exchanger configuration aiming at fluid loss reduction.

◆ High-efficiency heat transfer fin

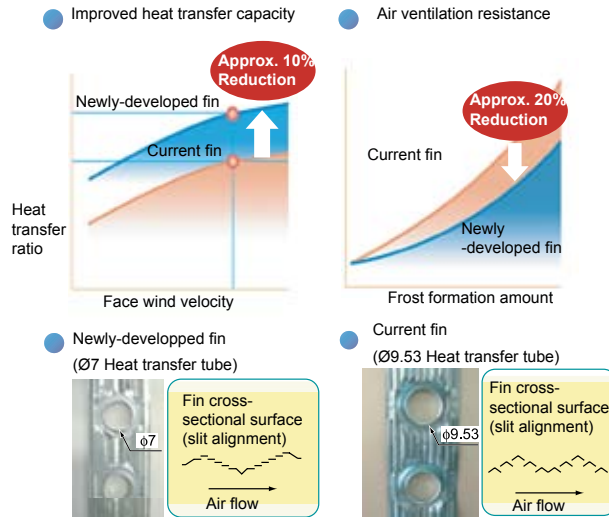

◆ Double DC Fan Motors

Double DC inverter-driven fan motors are equipped in the 2-row and 3-row cabinet. High-efficiency and low noise operation is realized.

◆ Super High-Stream & High-Efficiency Fan

- Newly adopted “4-blade super high-stream fan” with $\phi 710$ diameter
- Reduction of fan motor input power consumption, rotation speed and noise (rotation speed reduction is approx. 25%.)

◆ Duct-Type Shroud

High-efficiency fan is realized by adopting duct-type shroud structure.

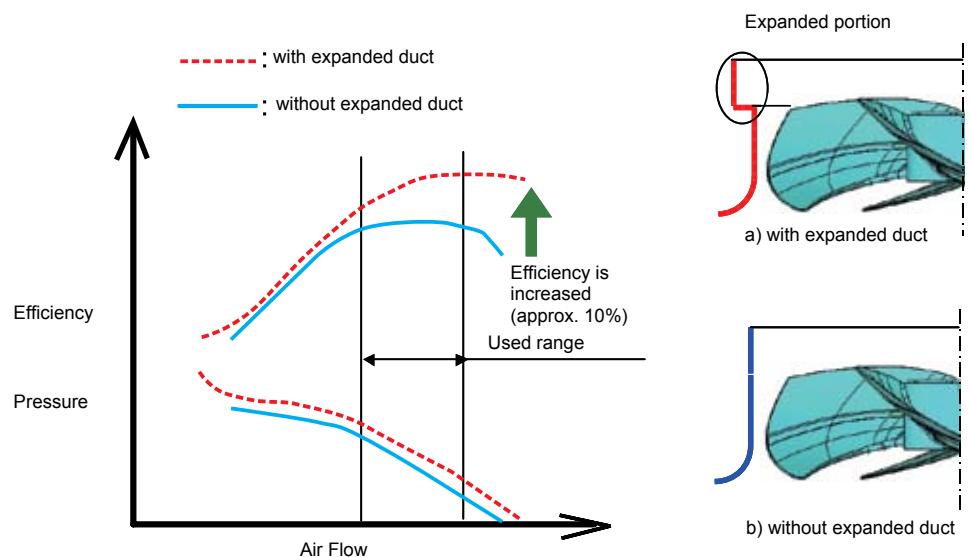
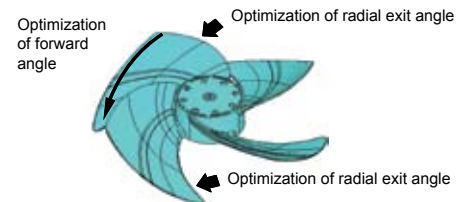

Functional benefits:

◆ Capacity Control by 1 Hz, the only one in the industry

Performance is greatly improved by the high efficiency DC inverter compressor and 100% load compressor, lossless energy-saving operation is achieved (depending on the building).

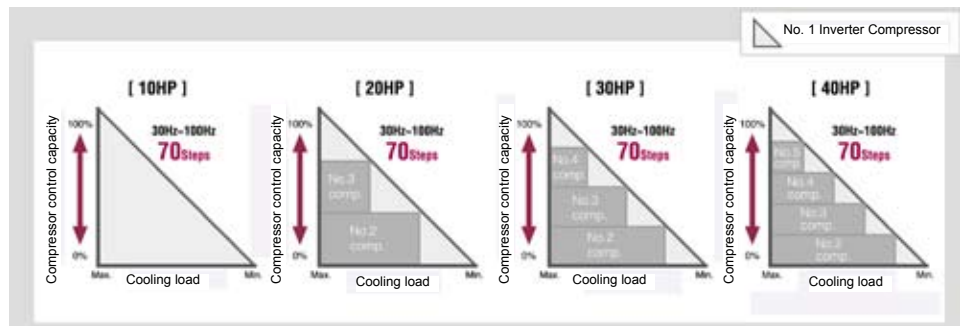

◆ Precise temperature setting

By properly controlling the refrigerant quantity by an electronic expansion valve, the temperature can be finely set.

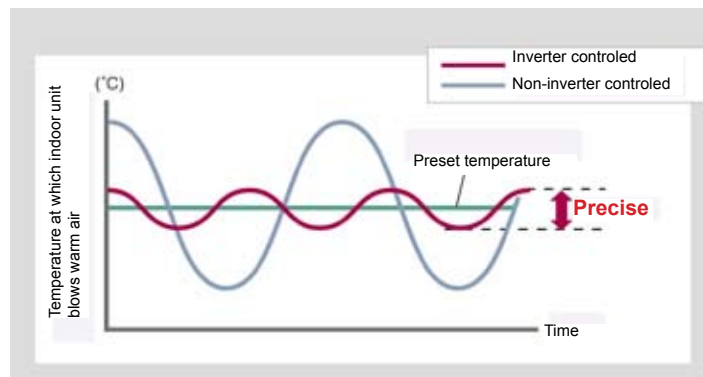

◆ Energy Saving

The industry-leading COP is achieved by adopting the following new technologies:

- New type DC Inverter compressor
- Large capacity constant speed compressor
- High-efficiency heat exchanger
- Double DC fan motors
- Super high-stream & high-efficiency fan
- Duct-type shroud

Industry-leading high-efficiency is achieved by adopting various "Energy saving technologies".

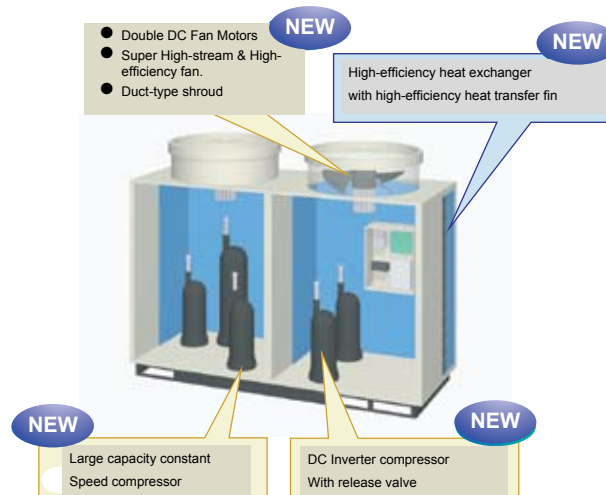

Functional benefits:

1.4.3. New functions

◆ **Self-Demand Control**

A newly developed self-demand function has largely improved energy-saving effects. Since the current is self-detected and demand control performed automatically, no signal wiring work is required. Conventional demand control using demand signals is also available, and you can select various operations as required.

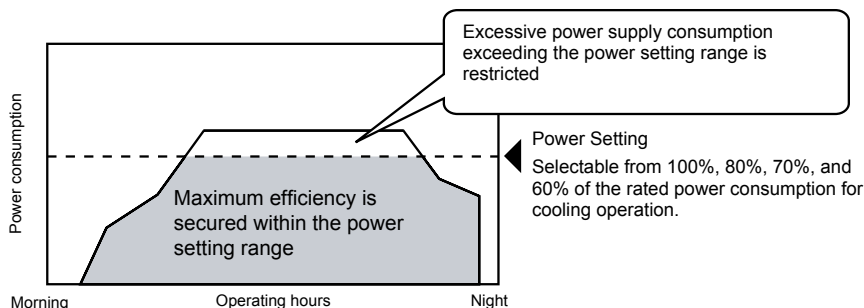

◆ **Wave-Mode**

Wave mode equipped to turn demand control ON and OFF alternately at intervals of about 20 min. or 10 min. While power is saved without fail, temperature changes are also minimized to maintain a comfortable room temperature.

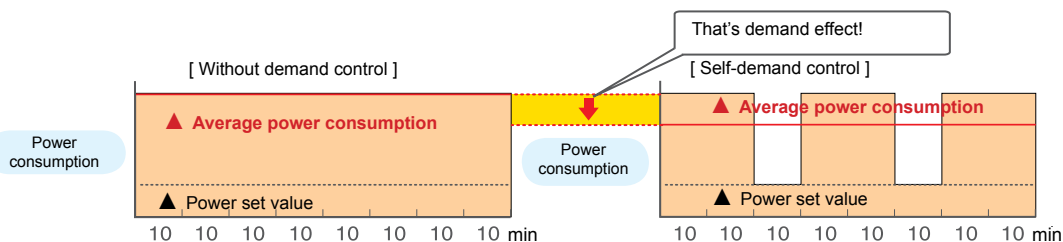

1

Functional benefits:

NOTES:

- An "Abnormal Outdoor Unit Fan" error message is available only for the unit equipped with multiple fans.
- The emergency operation is available only for when the following alarm codes are indicated.
- The emergency operation is not affected by the failure of the inverter PCB or fan controller.
- The emergency mode is available only with PC-ART

NOTES:

1. The refrigerant over-charging is not detected. Use this function by gradually adding refrigerant from but also it may cause the failure.
2. This function does not provide automatic refrigerant charging.
3. The adjustment (estimate) is changed by the operation condition (the number of operating units and temperature).
4. The operation is realized in cooling operation.

◆ **Emergency mode operation from remote control switch**

If compressor/fan motor is failed, emergency operation mode is available to change from the remote control switch. Even if the compressor is failed, the air conditioning operation is continuously available until the troubleshooting is performed.

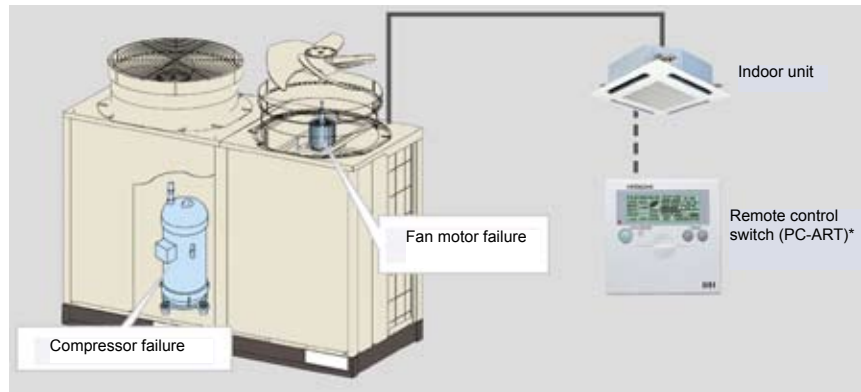

PC-ART

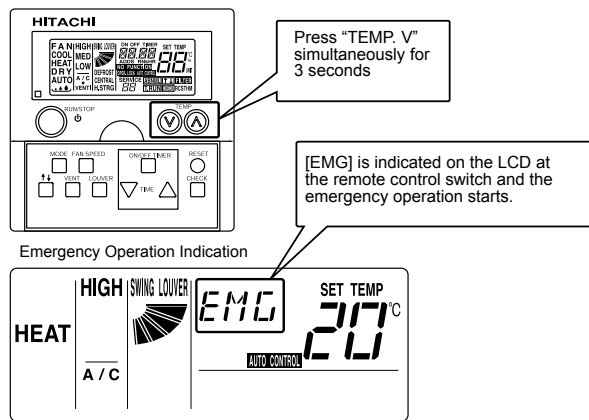

(*) Alarms Corresponding to Emergency Operation:

- 1) Inverter Compressor Failure
06: Abnormality of Inverter Voltage
23: Failure of Discharge Gas Thermistor
52: Inverter Overcurrent Protection Activation
51 to 54: Failure of Inverter Current Sensor
Transistor Module Protection Activation
Failure of Inverter Fin Thermistor
- 2) Constant Speed Compressor Failure
23: Failure of Discharge Gas Thermistor
39: Abnormality of Running Current at Constant Speed Compressor
- 3) Outdoor Fan Motor Failure
56 to 58: Abnormal Outdoor Fan Operation

◆ **New function for adequate refrigerant quantity measurement**

A New function for adequate refrigerant quantity measurement is adopted for all unit models. If refrigerant leakage occurs or refrigerant piping length is inadequate, this function measures the adequate refrigerant quantity by refrigerant cycle pressure or temperature. This function is of practical use for adequate refrigerant charging at test run or servicing.

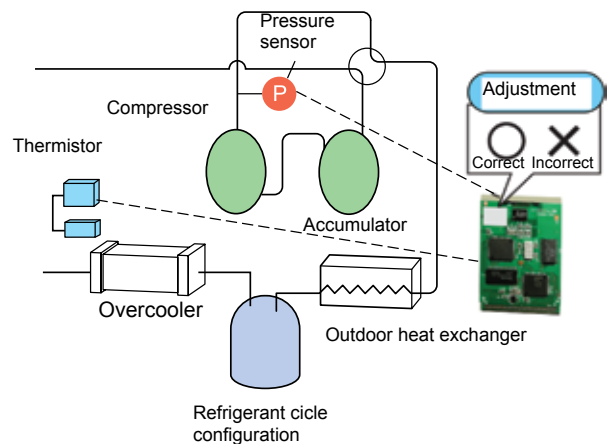
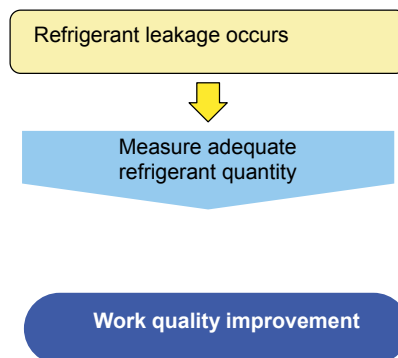

◆ **Protection for discharge air temperature drop at cooling operation**

This function is to protect the cold draft while cooling operation at intermediate season or low temperature. This function provides comfortable air conditioning.

Functional benefits:

1.4.4. Temperature Range

◆ Wide working range

This unit has been designed for cooling operation under low ambient temperatures down to -5°C .

This feature enables cooling to be obtained even in winter on buildings with high internal heat gains due to lighting, people and machines, particularly in areas such as shops, lecture rooms, data processing areas, etc.,

And the heating operation under low ambient temperatures down to -20°C can be also performed.

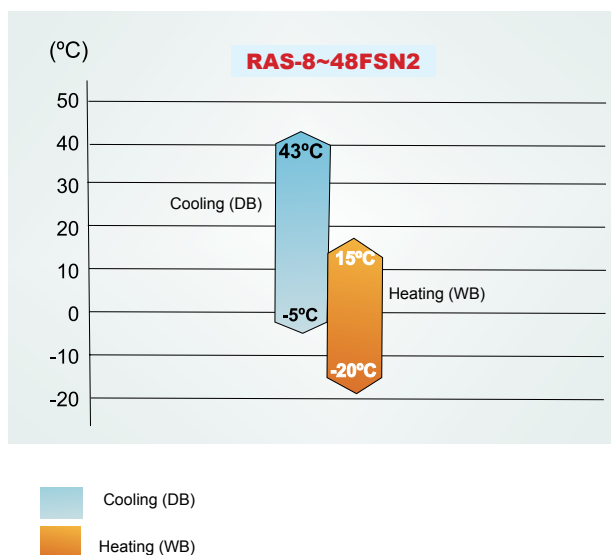

1.4.5. Precise control with the wide range inverter

The compressor speed for FSN2 series outdoor unit is controlled within a wide range of from 20Hz to 100Hz. Therefore, smooth operation is available without frequently using the ON/OFF control. This new wide range capacity control can meet not only the needs of a wide space but also a small space such as guest rooms and management rooms. Defrosting operation can be quickly performed by a high compressor speed.

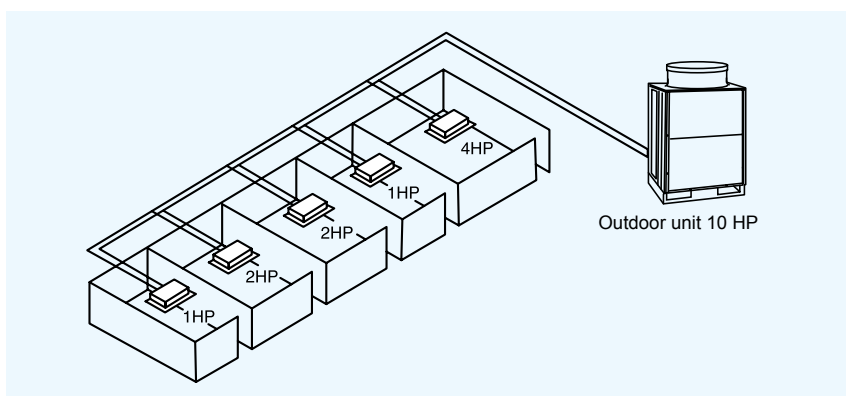

1.4.6. Multiple capacity control

To effectively operate the indoor units, the most appropriate refrigerant flow volume is controlled by the number of operating indoor units.

By sensing the air temperature difference between the inlet and outlet of the indoor unit, the electronic expansion opening is controlled to supply the most appropriate refrigerant flow volume. All units can be operated according to their separate operating conditions.

Due to the new control method, we are able to provide 15 meters (almost equal to a 4 floor height) lift between indoor units, resulting in flexible installation.

Functional benefits:

1.4.7. Electronic capacity control

The capacity of the 8 to 12HP outdoor unit is continuously controlled by the inverter from 20% to 100%. This wide working range has been obtained by the improvement of shaft strength and high pressure oil circulation in the scroll compressor. Therefore, an air conditioning system where heat load is greatly changed through the day is easily catered for.

Also, the capacity of each indoor unit is controlled by detecting the inlet and outlet temperatures using an electronic expansion valve. Therefore even a small room down to a 0.8HP indoor unit can be air conditioned without unwanted ON/OFF operation, resulting in comfortable air conditioning.

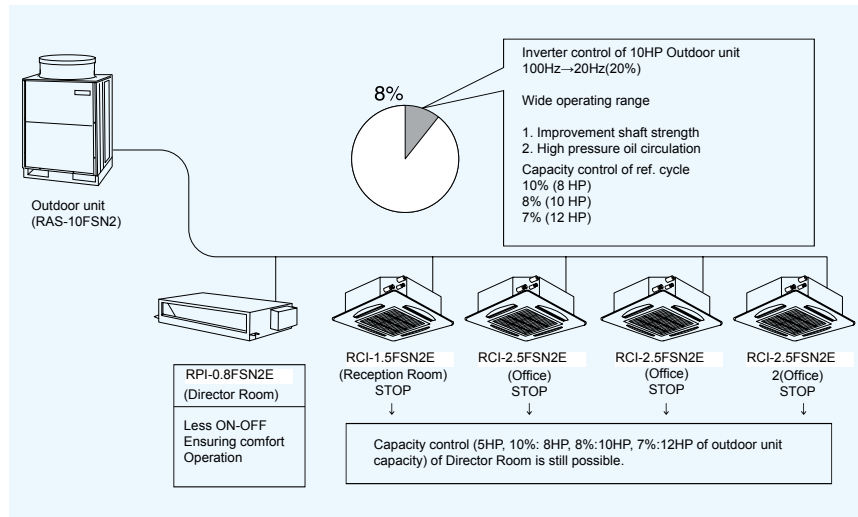

1.4.8. Individual operation at minimum 0.8 HP indoor unit

- The electronic expansion valves installed not only in the outdoor unit, but also in each indoor unit, control the refrigerant flow.

1.4.9. Drying operation control

- This system combining the inverter speed control with indoor air volume control performs efficient dehumidification with negligible change in room temperature.

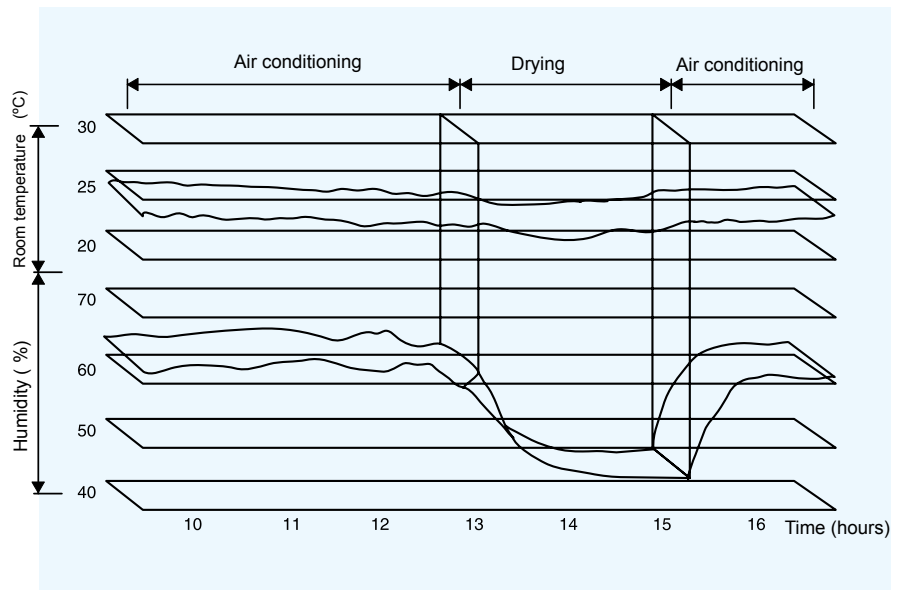

👉 Functional benefits:



Compressor with acoustic
insulation

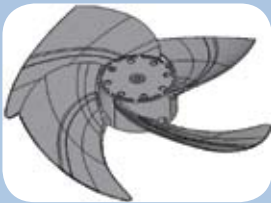

Newly adopted "4-Blade Super
High-Stream Fan"

1.4.10. Silent Compressor

SET FREE units have been designed with a compressor that reduces to the maximum the noise level.

The combined use of scroll compressors and an insulation jacket reduces noise.

The neodymium magnets in the rotor of the DC compressor improve the performance of the compressor at low frequencies, and a significant reduction of electromagnetic disturbance has been achieved by separating the rotor into two parts.

1.4.11. Silent fan

◆ **Low operation sound resulting from new fan shape and propeller fan material.**

The most appropriate fan shape for smooth air flow has been researched. Consequently, a new fan shape has been developed to minimize air turbulence around the propeller fan. Also, a new material of MRP (Mica polypropylene) which minimizes vibration characteristics against vibration sound has been adopted, and a laminated surface prevents turbulent flow. This combination has resulted in a low operation sound which was almost impractical in the previous units.

◆ **Low Sound Operation by Low Noise Fan Motor**

In order to minimize electromagnetic sounds, research was thoroughly performed on the materials to be used for the assembled fan motor.

Consequently, aluminum die-casting was selected and a low sound operation has been achieved without decreasing the operation performance. Also, a non-resonance suspension structure has been adopted to support the fan motor. Due to this structure, the vibration sound has been minimized.

◆ **Lower Sound Operation during Night Time**

Through computer simulation of fluid turbulence which is the main source of unwanted noise, and by visual observation of fluid flow, operation sound has been thoroughly analyzed.

By improvement of the cabinet structure and fan shape, and by the adoption of a new material and inverter, operation sound has been reduced.

Friendly to people and the environment alike, a low sound operation design has been obtained

 Maintenance benefits:

1.5. Maintenance benefits

1.5.1. High reliability

◆ **Minimum maintenance**

Faithful to Hitachi's usual philosophy, SET FREE units have been designed to guarantee great reliability and robustness in order to reduce maintenance operations to a minimum.

1.5.2. Easy maintenance

◆ **Easy access**

It is easy to access all components of the SET FREE systems. You can access all the components of the unit to carry out necessary tasks via a simple cover

The whole system is designed to facilitate and simplify maintenance.

◆ **Alarm information in the remote control switch through the PCB**

Alarm signals can be received through the remote control switches (whether individual or centralized), the CSNET WEB software, or via the electric plate of the outdoor unit, thus facilitating maintenance work.

◆ **Alarm codes**

The alarms are grouped by elements within the system in order to facilitate maintenance work and optimize the fitter's job.

◆ **SMS Alarm**

The alarm signals can also be received through a simple SMS specifying the cycle affected and the alarm code, allowing incidents to be detected and solved more quickly.

1.5.3. Availability of Maintenance Tools

All the functions of the Hitachi Service Tools for setup are applicable to unit maintenance, both preventive and corrective, so that any problem can be detected and solved immediately.

CSNET WEB is also useful for maintenance tasks.



Easy access



Alarm reception via
remote control switch
(PC-ART)



Alarm reception
through SMS



CSNET WEB as
maintenance tool

**Main features
of the units:**

- 1** Reduced piping pressure loss in the unit.
 - 2** Optimized expansion valve control.
 - 3** Optimized heat exchanger.
 - 2-gas, 1-liquid pass arrangement
 - subcooler in front
- Supercooling circuit adopted
Piping pressure loss decreased by subcooling in liquid pipes

1.6. Main features of the units

The SET FREE FSN2 systems are characterized by their great efficiency, thanks to all the technology applied.

◆ High efficiency refrigerant cycle

- Supercooling Circuit

-By using a supercooling circuit for the refrigeration cycle and optimizing the piping system, the performance is greatly improved.

Example RAS-8~12FSN2 Refrigerant cycle outline diagram

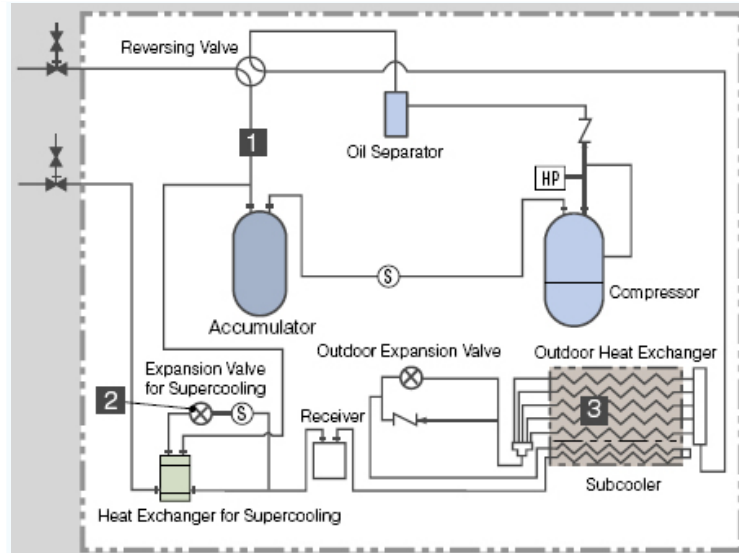

- Performance improved by high-efficiency plate type heat exchanger.

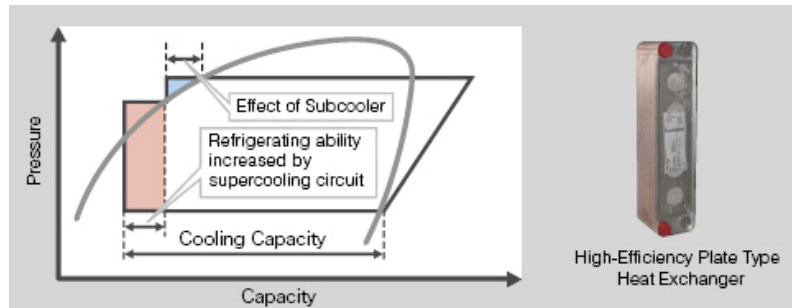

- New High-Efficiency heat exchanger

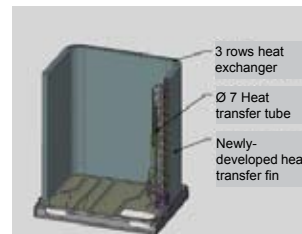

- High-Efficiency heat transfer fin.

- Improved heat transfer capacity (10% up)
- Air ventilation resistance reduction (20% down)
- Newly developed fin (Ø7 Heat transfer tube)

◆ New type DC Inverter Scroll Compressor

☞ Main features
of the units:



Scroll Compressor

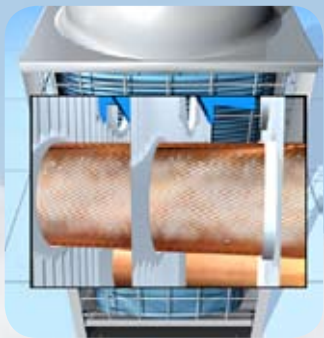

Exchange fin

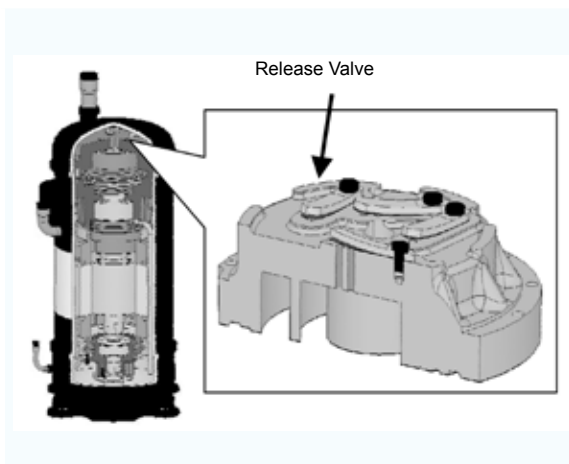

The strong points of the new type DC Inverter Scroll Compressor

- Improved Intermediate Pressure Performance
- The intermediate pressure performance is drastically improved by adopting release valve and optimizing orbiting scroll lifting force at the improved new compressing mechanism, therefore intermediate pressure performance is widely improved for energy saving.

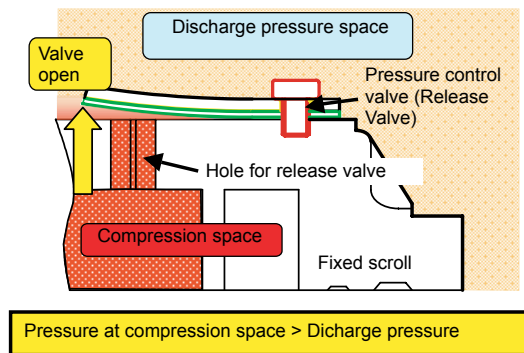

- Orbiting Scroll Lifting Force Optimization is Improved Leakage Loss Reduction
- Release Valve Adoption Prevents from Overcompression. This new system of regulating pressure, increasing the compressor's efficiency and reliability in part load mode. This system ensures the work pressure of the compressor is always at optimum level regardless of the charge, so that the ratio between the discharge pressure (P_d) and the suction pressure (P_s) is optimum as shown in the next graphic:

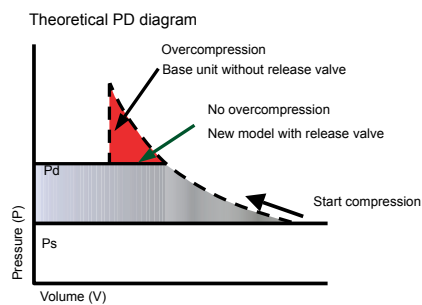

**Main features
of the units:**

1

◆ **Low noise level**

- Noise and vibration

1. The scroll compressor offers low sound and vibration levels because the compression points are spread evenly over the compression stroke, resulting in a very flat torque curve.
2. The minimal number of components used coupled with a high-pressure shell that acts as a silencer further enhances the noise reduction.
3. Because the noise pattern is high-frequency sound it is simple to reduce it to a very low level by using an insulation jacket.
4. Reducing electromagnetic compressor noise.

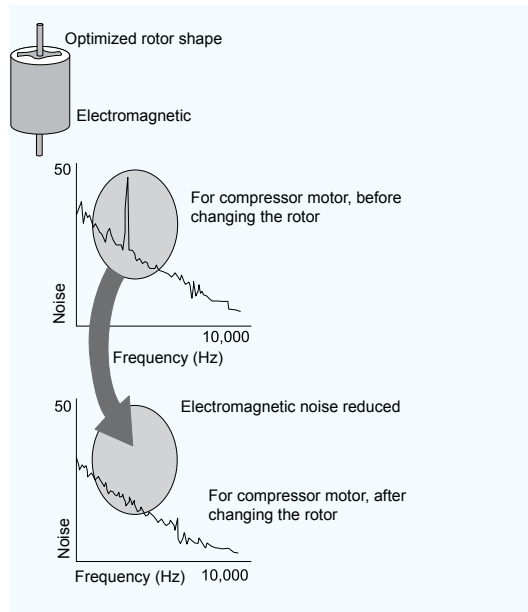

- Protection against liquid return

When the compressor is at rest, the moving scroll rests on the casing. When the compressor starts to run, the pressure in the chamber under the scroll builds up through two bleed holes in the medium pressure section of the compression stroke. This pressure then forces the scroll up against the housing and seals the compression chamber. If liquid returns to the compressor, the resulting increase in pressure forces the Scroll downwards breaking the seal which allows the liquid to pass back into the compressor body where it will boil off due to the higher temperature.

◆ **Efficiency**

- DC Compressor using Neodymium Magnet.

The use of a DC compressor improves the performance at around the 15-40 Hz range where the operation time of the inverter compressor is longest. Additionally, to suppress electromagnetic noise interference and achieve low noise, the rotor has been divided into two parts and the electric pole displaced.

There have been significant improvements in low-speed features, which affect the annual running cost.

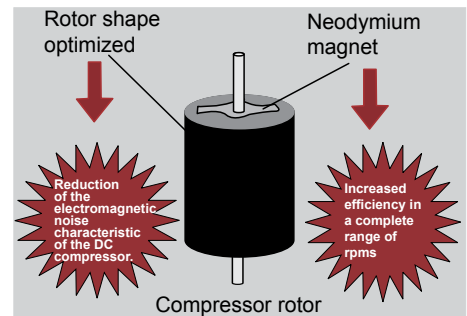
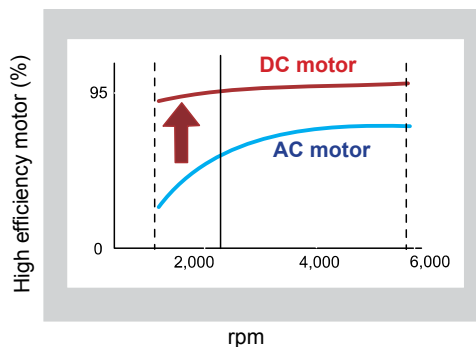

☛ Main features
of the units:

◆ **Inverter control**

The inverter controls compressor speeds from 15 Hz to 100 Hz, quickly reaching the set temperature and maintaining a stable energy-saving operation, thus reducing the noise since the compressor is not running continuously.

Diagram of operation (in heating mode):

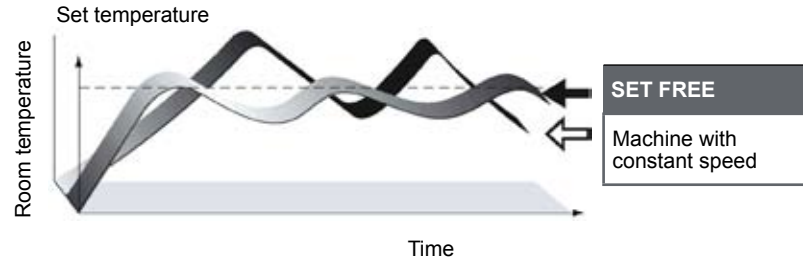

- In the case of Set-Free
Quickly reaches set temperature with high power, then maintains stable energy-saving operation.
- In the case of other constant speed machines:
Slowly reaches the set temperature, then turns on and off repeatedly to maintain the temperature, causing uneconomical operation and “power waste”

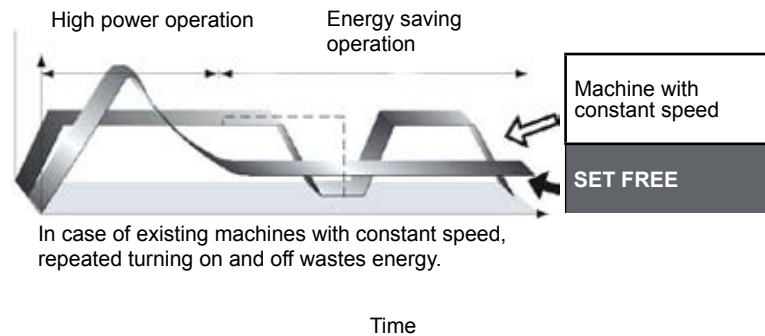

In case of existing machines with constant speed, repeated turning on and off wastes energy.

◆ **Enhanced fan motor features**

- Double DC fan motors
Double DC inverter-driven fan motors are equipped in the 2-row and 3-row cabinet. High-efficiency and low noise operation is realized.
- Super high-stream & high-efficiency fan
 - Newly adopted “4-blade super high-stream fan” with $\varnothing 710$ diameter
 - Reduction of fan motor input power consumption, rotation speed and noise.
(Rotation speed reduction is approx. 25%.)
- Duct-type shroud
High-efficiency fan is realized by adopting duct-type shroud structure

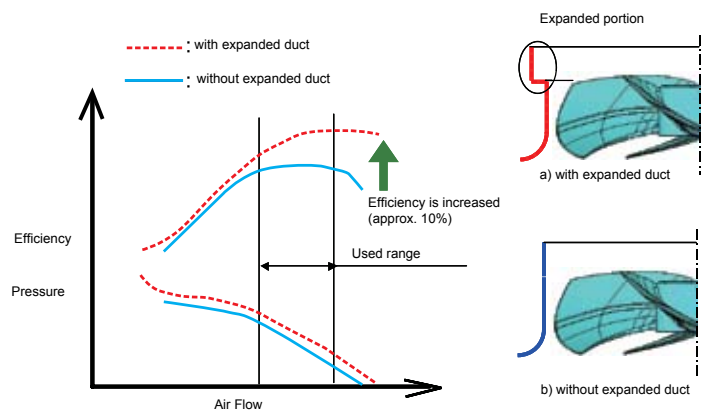
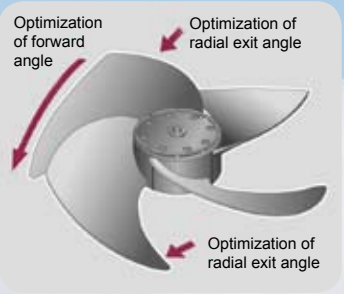

☛ Main features
of the units:

1

◆ **Reduced total outdoor unit capacity**

The SET FREE system enable the outdoor unit to be up to 30% smaller capacity when compared with the current split air conditioning systems. The diagram shows a typical building with a morning peak heat load on the east zone equivalent to a 6HP unit.

In the afternoon a peak occurs on the west zone equivalent to a 7HP unit.

Therefore, a conventional system would require total installed plant of 6HP + 7HP = 13HP. The maximum simultaneous load on the whole building occurs at noon and is equal to 10HP of unit capacity. A Set-Free System of 10HP can therefore be selected, and this capacity can be directed either to the east or west zone as dictated by the system controls.

$$\text{Saving in installed plant} = \frac{13-10}{13} \times 100 = \mathbf{23\%!!!}$$

◆ **Example of Air conditioning for building**

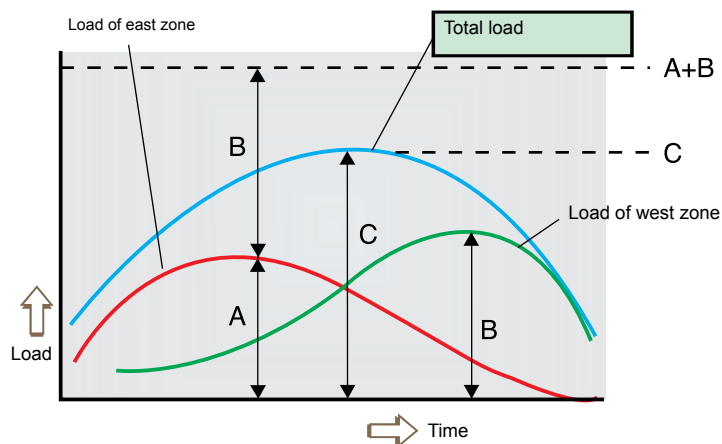

- Current type: Selection by total capacity of each maximum load (A+B)



- SET FREE: Selection by total load which occurs simultaneously

$$A+B:C = 1 : 0.80 \text{ to } 0.85$$

Since partial operation is obtained due to plural indoor unit, the outdoor unit capacity can be selected according to the total load of a building in a day.

◆ **SET FREE**

Supplies refrigerant according to the load of each room.

$$\text{Load diversity} = \frac{10}{13} = \mathbf{0.77}$$

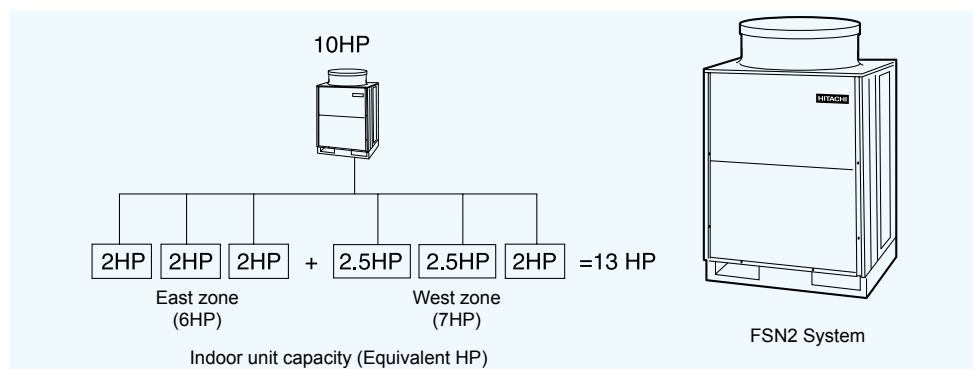

☞ Main features
of the units:



CSNET-WEB

◆ **Large variety of operating possibilities**

The use of these machines together with CSNET WEB can increase the performance of these installations even more by the following:

- With a program that avoids continuous functioning in rooms without users and allows heating and cooling just before rooms are occupied.
- Limiting the set temperatures, which means that machines do not work at maximum capacity when comfort does not require it.
- Locking functions from the central control, thus avoiding incorrect or ineffective use of the units.
- All these and many more functions mean that the use of the installation as a whole can be optimized.
- And it is worth remembering that because of the wide range of indoor units you can always find the unit with the power and type of installation that best suits your needs.

☛ Main features
of the units:



1.6.1. Complementary Systems

◆ Fan Units with Energy Recovery, KPI

- What is a KPI

A KPI is a ventilation unit designed to renew the air from a room or area taking out the exhaust air and supplying fresh outdoor air. To reduce the effect of supplying outdoor air in a conditioned room with a big temperature gap between them, the KPI exchange temperature and humidity between both streams, which will make that the outdoor air had a temperature and humidity levels more similar to indoor conditions. The air treatment over outdoor fresh air before supplying leads to a reduction of the air conditioner system load requirement.

The part responsible of the exchange between both streams is the heat exchanger. The heat exchanger is a cross-flow sheet made of ultra-thin celluloid material that allows an energy exchange by crossing both streams without mixing.

The main benefit of a KPI unit versus other ventilation systems is the possibility to income outdoor air already processed to reduce its temperature and humidity differences with indoor conditions. This treatment reduces the air conditioner system load, which could mean a reduction up to 20% in the whole system power input.

- High efficiency heat exchanger

The heat exchanger is a combination of celluloid ultra-thin plates of 46 µm. Between each plate there are fins of the same material that prevent of mixing both streams. The result is a cross flow of incoming and outgoing streams.

1

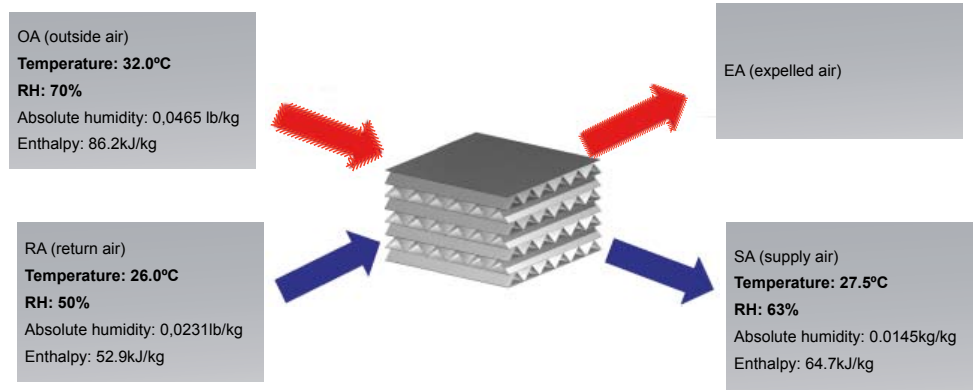

Being separated by the celluloid material, there is an enthalpy exchange between both streams by convection, always from the one with higher level, approaching the fresh air to indoor conditions.

Winter operation

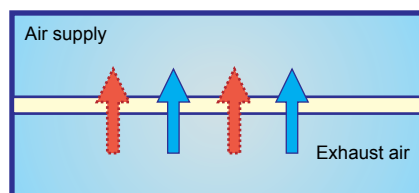

Summer operation

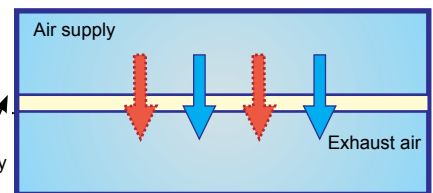

- Humidity transfer (KPI-(502~2002)E1E units)
- Heat transfer

☛ Main features
of the units:



KPI units from 500 m³/h to 2000 m³/h have been designed considering the possibility of using them also with an aluminium heat exchanger instead of the factory supplied one in order to fulfil any installation requirement. On the other hand, the biggest unit of 3000 m³/h air flow has been designed only for using it with an aluminium heat exchanger.

The aluminium heat exchanger principle is the same than for celluloid heat exchangers, but by changing the material the exchange of humidity is not performed, so only the temperature will be exchanged.

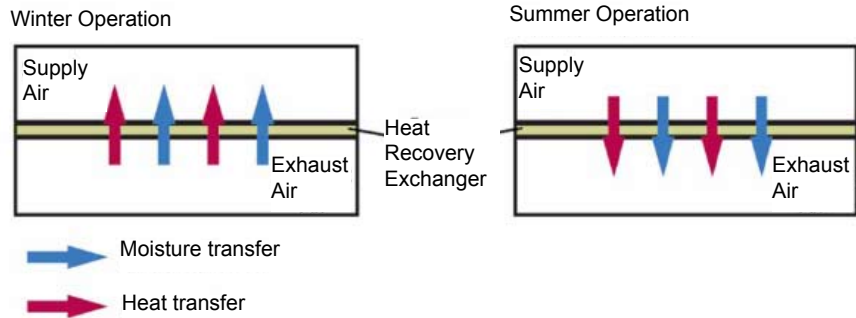

The fact of not exchanging humidity and the different properties of aluminium makes that the efficiency of the unit decreases in case of using the aluminium heat exchanger.

- Overload option

If the area to ventilate is a room with different uses depending the zone (dinner areas besides kitchens, rooms next to wet rooms,...) the KPI units can be set to perform an overload on the supplied air that avoids the flow of polluted air or smells.

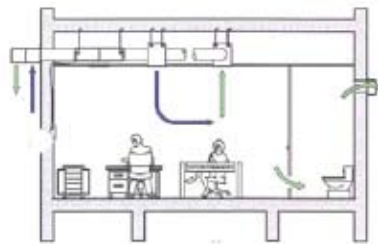

By setting the remote controller the user could increase one tap the speed of the supplied air fan versus the exhausted air fan. The result is a higher supplying air flow versus the exhausted flow increasing the pressure of the room. This option could be also used in installations where additional extraction systems must be installed to fulfil local regulations. The increased supplied air flow would be able to balance the effect of these extraction systems looking for the best comfort conditions.

- Operation modes

The units from 500 m³/h to 2000 m³/h have two different operation modes: heat exchange mode and bypass mode.

- If the unit is set in heat exchange mode both streams will cross the heat exchanger element. All features of the unit are performed obtaining the maximum efficiency.
- In case of having an outdoor temperature very close to set indoor temperature, it could be better to avoid the exchange between both streams. For this situation, KPI units have a dumper in exhausted stream that bypasses the heat exchanger element. The outdoor air is then supplied directly from outside.

For choosing between the two operation modes there are three options:

- Automatic mode: Depending indoor and outdoor air sensed temperature and set indoor temperature, it is the control itself that decides which mode is the most appropriate one.

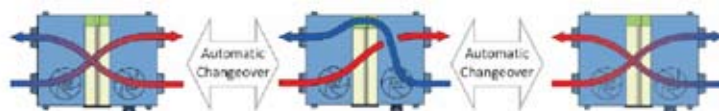

☛ Main features
of the units:

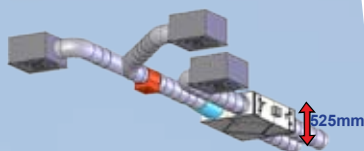

- Forced exchange mode: The dumper is always closed with no incidence of indoor and outdoor air temperatures.
- Free ventilation mode: The dumper will be always open, so the outdoor air will be introduced directly into the room at any temperature it could be.

- Main features of KPI design

- Range of units

A large range of units are available from 500 m³/h to 3000 m³/h nominal air flows.

Model	Flow (m ³ /h)	Temperature Exchange Efficiency
KPI-502E1E	500	75
KPI-802E1E	800	75
KPI-1002E1E	1,000	78
KPI-1502E1E	1,500	78
KPI-2002E1E	2,000	78

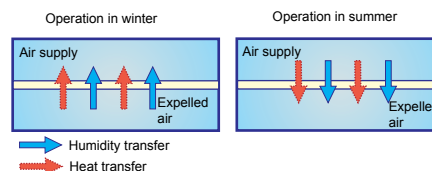

• KPI models with heat recovery:

Model	Flow (m ³ /h)	Temperature Exchange Efficiency
KPI-3002H1E	3,000	54

- Installation

KPI units are very easy to install. It is only necessary the installation of the unit itself in the false ceiling or wherever considered and the installation of the air ducts. As this unit don't have any evaporator no piping work is required except for the drain connection (on the bottom of the unit).

Integrated in a system, the KPI could be connected to charge/discharge grilles or to indoor units available to work with outdoor air.

- Operation flexibility

KPI units have been designed looking for the highest operation flexibility:

- Possibility to change the celluloid heat exchanger by aluminium heat exchanger when it is necessary to avoid the humidity transfer or when the heat exchanger servicing must be reduced for any reason.
- There are three speeds selectable from the remote controller: high, medium and low. In units from 500 m³/h to 1500 m³/h there is also available an extra-high speed for installations where a higher pressure is required.
- Three operation modes: automatic mode, forced heat exchange and free ventilation mode.

i NOTE:

When the indoor unit air is supplied from a KPI unit the working range of the indoor unit should be considered.

1

☛ Main features
of the units:



- Servicing:
All the parts subjected to servicing are completely accessible from outside the unit, with no necessity to uninstall it. The fan motors are accessible from the bottom of the unit, and the heat exchanger and air filter are accessible from one side of the unit, both of them by the same service cover. E-box is just next to heat exchanger/ air filters service cover



- Noise level. Sound attenuator accessory
Discharge sound level is very important in this kind of units because it is the sound introduced into the room that the people will sense. In addition to an accurate design for minimising the ventilation sound emitted from the unit, there is available a range of sound attenuators easily attachable to the unit with no need of an extra-installation work. The effect of the sound attenuator is a reduction of 7dB(A) on the pressure level sensed in the discharge side.

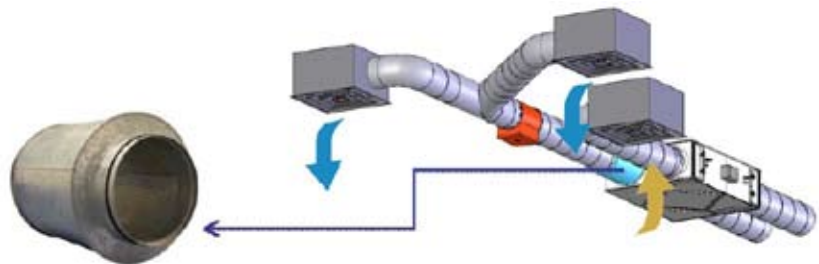

- Air Filters
KPI units have two air filters: one for outdoor air and another one for the exhausted air. The filters are located after the fan but before the heat exchanger, avoiding the pollution from outside/inside and the possible emissions by the fan motor to affect the heat exchanger efficiency and ensuring the supplied air quality.

☛ Main features
of the units:

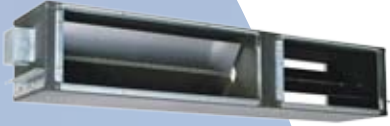

1

◆ Econofresh Kit

The new Econofresh kit is an intelligent accessory device that is easily installed. It renews room air and saves energy.

No coolant cycle is required. A direct RPI-5HP unit return duct connection is used instead.

The Econofresh kit can provide up to 100% fresh air and has the ability to provide "free cooling" through the damper when the outdoor temperature is below the indoor setting temperature.

This system will not only maintain the correct room temperature and provide fresh air, but also natural cooling. It therefore increases energy savings.

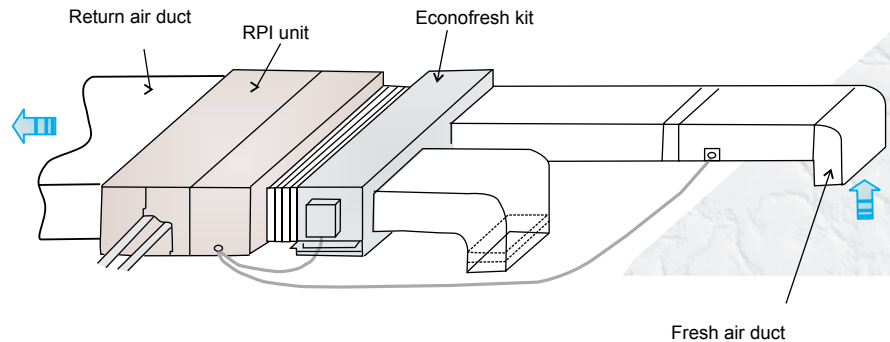

◆ Operation mode

Fresh air cooling during intermediate seasons saves energy.

This unit uses an economizer for cooling, which takes in fresh air if the outdoor temperature is cooler than the indoor air, as shown in the graph below.

In this situation, no compressor is used and thus a remarkable amount of energy is saved.

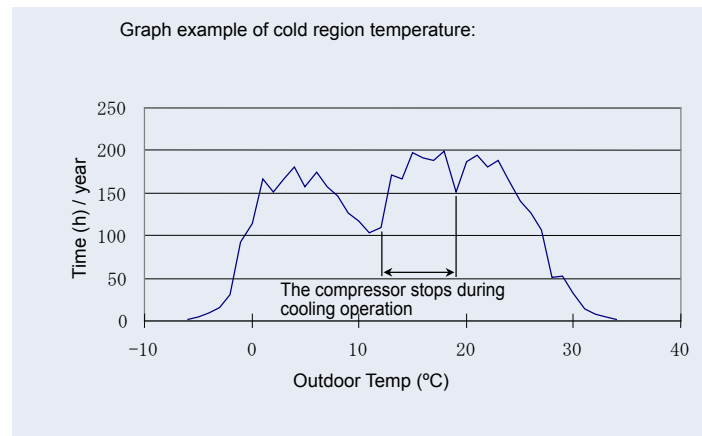

The power consumption is reduced by more than 20% during operating mode with cooling by using the Econofresh + kit RPI-5.0FSN2E.

- Fresh clean air revives your room

A fresh air intake system keeps the air in a room always clean.

The optional CO₂ sensor can sense the degree of pollution of the air in the room and automatically control the fresh air flow.

i NOTE:

In the case that the Outdoor Air Temperature is lower than 3°C, Fresh Outdoor Air rate will decrease.

Damper air-flow control provides comfortable cooling

A micro-computer controls the angle of the damper according to both room air temperature and outdoor temperature to adjust the fresh air flow, thus keeping the room temperature constant.

2. General Data

This chapter offers a summary of the most important general data of the SET FREE FSN2 Series.

Contents

Contenido

2. General Data	59
2.1. General Data for RAS-FSN2 units.....	60
2.1.1. General data for RAS-8~12FSN2	60
2.1.2. General data for RAS-14~24FSN2	61
2.1.3. General data for RAS-26~42FSN2	62
2.1.4. General data for RAS-44~48FSN2	64
2.2. Component data for RAS-FSN2 units	65
2.2.1. Fan and heat exchanger of RAS-8~12FSN2	65
2.2.2. Fan and heat exchanger of RAS-14~24FSN2	65
2.2.3. Fan and heat exchanger of RAS-26~32FSN2	66
2.2.4. Fan and heat exchanger of RAS-34~42FSN2	66
2.2.5. Fan and heat exchanger of RAS-44~48FSN2	67
2.3. Component data for compressor	67

2



2.1. General Data for RAS-FSN2 units

2.1.1. General data for RAS-8~12FSN2

RAS MODEL		RAS-8FSN2	RAS-10FSN2	RAS-12FSN2	
Electrical power supply		3~,380/415V, 50Hz			
Nominal cooling capacity	kW	22.4	28.0	33.5	
Nominal heating capacity	kW	25.0	31.5	37.5	
Energy efficiency in cooling mode (EER)	-	4.10	4.04	3.86	
Energy efficiency coefficient in heating mode (COP)	-	4.72	4.65	4.01	
Color (Munsell code)	-	Natural gray (1.0Y 8.5/0.5)			
Sound pressure level (night mode)	dB(A)	56 (51)	58 (53)	60 (55)	
Sound power level	dB(A)	To be informed later			
External dimensions	Height	mm	1,670	1,670	
	Width	mm	1,080	1,080	
	Depth	mm	830	830	
Net weight	Kg	275	275	275	
Refrigerant	-	R410A			
Flow control	-	Micro-computer control expansion valve			
Compressor	-	Hermetic (scroll)			
Q'ty	-	1	1	1	
	Power	kW	4.8	6.0	7.2
Heat exchanger	-	Multi-pass cross-finned tube			
Outdoor fan	-	Propeller fan			
Q'ty	-	1	1	1	
	Air flow rate	m ³ /min	138	172	185
	Power	W	380	380	380
Refrigerant pipe connection		Flare-nut connection (with flare nuts)			
Size	Liquid piping	mm (in)	ø9.53-ø12.7 (3/8)-(1/2)	ø9.53-ø12.7 (3/8)-(1/2)	ø12.7-ø15.88 (1/2)-(5/8)
	Gas piping	mm (in)	ø19.05-ø22.2 (3/4)-(7/8)	ø22.2-ø25.4 (7/8)-(1)	ø25.4-ø28.6 (1)-(1-1/8)
Refrigerant charge	Kg	10.00	10.50	11.00	
Maximum electrical current	A	12.0	15.0	20.0	
Packaging measurements	m ³	1.85	1.85	1.85	

i NOTE:

- The nominal cooling and heating capacity are the combined capacity of the SET FREE system, and is based on EN14511.

Operation condition		Cooling	Heating
Indoor air inlet temperature	DB	27 °C	20 °C
	WB	19 °C	
Outdoor air inlet temperature	DB	35 °C	7 °C
	WB		6 °C

Piping Length: 7.5 meters; piping lift: 0 meters
DB: Dry Bulb; WB: Wet Bulb

- The sound pressure level is based on following conditions:

- 1 meter from the frontal surface of the unit.
1.5 meters from floor level.
- Voltage of the power source is 230V

The above data was measured in an anechoic chamber, so reflected sound should be taken into consideration when installing the unit.

The sound pressure data is based on the cooling mode. In case of heating mode, the sound pressure level increases by approximately 1 or 2 dB.

- COP and EER data correspond to Outdoor unit (Indoor unit input power is not considered). Outdoor unit performance has been established in 100% combination with RCI-FSN2E model.



2.1.2. General data for RAS-14~24FSN2

2

RAS MODEL		RAS-14FSN2	RAS-16FSN2	RAS-18FSN2	RAS-20FSN2	RAS-22FSN2	RAS-24FSN2	
Electrical power supply		3~,380/415V, 50Hz						
Nominal cooling capacity	kW	40.0	45.0	50.4	56.0	63.0	69.0	
Nominal heating capacity	kW	45.0	50.0	56.0	63.0	71.0	77.5	
Energy efficiency in cooling mode (EER)	-	3.91	3.90	3.83	3.69	3.65	3.61	
Energy efficiency coefficient in heating mode (COP)	-	4.54	4.44	4.47	4.13	3.99	4.13	
Color (Munsell code)	-	Natural gray (1.0Y 8.5/0.5)						
Sound pressure level (night mode)	dB(A)	58 (53)	58 (53)	62 (57)	62 (57)	62 (57)	62 (57)	
Sound power level	dB(A)	To be informed later						
External dimensions	Height	mm	1,670	1,670	1,670	1,670	1,670	
	Width	mm	1,850	1,850	1,850	1,850	1,850	
	Depth	mm	830	830	830	830	830	
Net weight	Kg	470	470	540	540	580	580	
Refrigerant	-	R410A						
Flow control	-	Micro-computer control expansion valve						
Compressor	-	Hermetic (Scroll)						
Q'ty	-	1+1	1+1	1+1x2	1+1x2	1+1+1	1+1+1	
	Power	kW	4.80+4.20	6.00+4.20	3.60+4.20x2	4.80+4.20x2	4.80+4.20+6.50	6.00+4.20+6.50
Heat exchanger	-	Multi-pass cross-finned tube						
Outdoor fan	-	Propeller fan						
Q'ty	-	2	2	2	2	2	2	
	Air flow rate	m ³ /min	130+140	130+140	185+175	185+175	185+175	185+175
	Power	W	380+380	380+380	380+380	380+380	380+380	380+380
Refrigerant pipe connection	-	Flare-nut connection (with flare nuts)						
Size	Liquid piping	mm (in)	ø12.7-ø15.88 (1/2)-(5/8)	ø12.7-ø15.88 (1/2)-(5/8)	ø15.88-ø19.05 (5/8)-(3/4)	ø15.88-ø19.05 (5/8)-(3/4)	ø15.88-ø19.05 (5/8)-(3/4)	ø15.88-ø19.05 (5/8)-(3/4)
	Gas piping	mm (in)	ø25.4-ø28.6 (1)-(1-1/8)	ø28.6-ø31.75 (1-1/8)-(1-1/4)	ø28.6-ø31.75 (1-1/8)-(1-1/4)	ø28.6-ø31.75 (1-1/8)-(1-1/4)	ø28.6-ø31.75 (1-1/8)-(1-1/4)	ø28.6-ø31.75 (1-1/8)-(1-1/4)
Refrigerant charge	Kg	18.0	18.0	19.5	19.5	20.0	20.0	
Maximum electrical current	A	22.0	25.0	29.0	34.0	39.0	43.0	
Packaging measurements	m ³	3.25	3.25	3.25	3.25	3.25	3.25	

NOTE:

- The nominal cooling and heating capacity are the combined capacity of the SET FREE system, and is based on EN14511.

Operation condition		Cooling	Heating
Indoor air inlet temperature	DB	27 °C	20 °C
	WB	19 °C	
Outdoor air inlet temperature	DB	35 °C	7 °C
	WB		6 °C

Piping Length: 7.5 meters; piping lift: 0 meters

DB: Dry Bulb; WB: Wet Bulb

- The sound pressure level is based on following conditions:

- 1 meter from the frontal surface of the unit.
1.5 meters from floor level.
- Voltage of the power source is 230V

The above data was measured in an anechoic chamber, so reflected sound should be taken into consideration when installing the unit.

The sound pressure data is based on the cooling mode. In case of heating mode, the sound pressure level increases by approximately 1 or 2 dB.

- COP and EER data correspond to Outdoor unit (Indoor unit input power is not considered). Outdoor unit performance has been established in 100% combination with RCI-FSN2E model.

2.1.3. General data for RAS-26~42FSN2



◆ RAS-26~34FSN2

RAS MODEL		RAS-26FSN2	RAS-28FSN2	RAS-30FSN2	RAS-32FSN2	RAS-34FSN2	
Electrical power supply		3~,380/415V, 50Hz					
Nominal cooling capacity	kW	73.0	80.0	85.0	90.0	96.0	
Nominal heating capacity	kW	82.5	90.0	95.0	100.0	108.0	
Energy efficiency in cooling mode (EER)		3.86	3.77	3.77	3.75	3.70	
Energy efficiency coefficient in heating mode (COP)		4.37	4.18	4.26	4.14	4.19	
Color (Munsell code)	-	Natural gray (1.0Y 8.5/0.5)					
Sound pressure level (night mode)	dB(A)	62 (57)	62 (57)	62 (57)	62 (57)	64 (59)	
Sound power level	dB(A)	To be informed later					
External dimensions	Height	mm	1,670	1,670	1,670	1,670	
	Width	mm	2,940	2,940	2,940	2,940	
	Depth	mm	830	830	830	830	
Net weight	Kg	780	780	840	840	840	
Refrigerant	-	R410A					
Flow control	-	Micro-computer control expansion valve					
Compressor	-	Hermetic (Scroll)					
Q'ty	-	1+1x2	1+1x2	1+1+1x2	1+1+1x2	1+1+1x2	
	Power	kW	4.80+6.50x2	6.00+6.50x2	3.60+4.20+6.50x2	3.60+4.20+6.50x2	7.20+4.20+6.50x2
Heat exchanger		Multi-pass cross-finned tube					
Outdoor fan	-	Propeller fan					
Q'ty	-	3	3	3	3	3	
	Air flow rate	m³/min	185+175+165	185+175+165	185+175+165	185+175+165	210+200+172
	Power	W	380+380+570	380+380+570	380+380+570	380+380+570	380+380+570
Refrigerant pipe connection		Flare-nut connection (with flare nuts)					
Size	Liquid piping	mm (in)	ø12.7-ø15.88 (1/2)-(5/8)	ø12.7-ø15.88 (1/2)-(5/8)	ø15.88-ø19.05 (5/8)-(3/4)	ø15.88-ø19.05 (5/8)-(3/4)	ø15.88-ø19.05 (5/8)-(3/4)
	Gas piping	mm (in)	ø25.4-ø28.6 (1)-(1-1/8)	ø28.6-ø31.75 (1-1/8)-(1-1/4)	ø28.6-ø31.75 (1-1/8)-(1-1/4)	ø28.6-ø31.75 (1-1/8)-(1-1/4)	ø28.6-ø31.75 (1-1/8)-(1-1/4)
Refrigerant charge	Kg	27.0	27.0	28.5	28.5	28.5	
Maximum electrical current	A	44.0	48.0	51.0	54.0	58.0	
Packaging measurements	m³	4.95	4.95	4.95	4.95	4.95	

i NOTE:

- The nominal cooling and heating capacity are the combined capacity of the SET FREE system, and is based on EN14511.

Operation condition		Cooling	Heating
Indoor air inlet temperature	DB	27 °C	20 °C
	WB	19 °C	
Outdoor air inlet temperature	DB	35 °C	7 °C
	WB		6 °C

Piping Length: 7.5 meters; piping lift: 0 meters
DB: Dry Bulb; WB: Wet Bulb

- The sound pressure level is based on following conditions:

- 1 meter from the frontal surface of the unit.
1.5 meters from floor level.
- Voltage of the power source is 230V

The above data was measured in an anechoic chamber, so reflected sound should be taken into consideration when installing the unit.

The sound pressure data is based on the cooling mode. In case of heating mode, the sound pressure level increases by approximately 1 or 2 dB.

- COP and EER data correspond to Outdoor unit (Indoor unit input power is not considered). Outdoor unit performance has been established in 100% combination with RCI-FSN2E model.



◆ RAS-36~42FSN2

2

RAS MODEL			RAS-36FSN2	RAS-38FSN2	RAS-40FSN2	RAS-42FSN2	
Electrical power supply			3~,380/415V, 50Hz				
Nominal cooling capacity	kW		101.0	107.0	113.0	118.0	
Nominal heating capacity	kW		113.0	119.5	127.0	132.0	
Energy efficiency in cooling mode (EER)			3.66	3.61	3.50	3.48	
Energy efficiency coefficient in heating mode (COP)			4.09	4.12	4.00	4.04	
Color (Munsell code)			- Natural gray (1.0Y 8.5/0.5)				
Sound pressure level (night mode)			64 (59)	64 (59)	64 (59)	64 (59)	
Sound power level			dB(A) To be informed later				
External dimensions	Height	mm	1,670	1,670	1,670	1,670	
	Width	mm	2,940	2,940	2,940	2,940	
	Depth	mm	830	830	830	830	
Net weight			Kg	840	915	915	
Refrigerant			-				
Flow control			-				
Compressor			-				
Q'ty			-	1+1+1x2	1+1+1x3	1+1+1x3	1+1+1x3
Power			kW	7.20+4.20+6.50x2	2.40+4.20+6.50x3	3.60+4.20+6.50x3	4.80+4.20+6.50x3
Heat exchanger			-				
Outdoor fan			-				
Q'ty			-	3	3	3	3
Air flow rate			m³/min	210+200+172	210+200+172	210+200+172	210+200+172
Power			W	380x2+570	380x2+570	380x2+570	380x2+570
Refrigerant pipe connection			-				
Size	Liquid piping	mm (in)	ø19.05-ø22.2 (3/4)-(7/8)	ø19.05-ø22.2 (3/4)-(7/8)	ø19.05-ø22.2 (3/4)-(7/8)	ø19.05-ø22.2 (3/4)-(7/8)	
	Gas piping	mm (in)	ø38.1-ø41.3 (1-1/2)-(1-5/8)	ø38.1-ø41.3 (1-1/2)-(1-5/8)	ø38.1-ø41.3 (1-1/2)-(1-5/8)	ø38.1-ø41.3 (1-1/2)-(1-5/8)	
Refrigerant charge			Kg	28.5	30.0	30.0	
Maximum electrical current			A	62.0	67.0	74.0	
Packaging measurements			m³	4.95	4.95	4.95	

i NOTE:

1. The nominal cooling and heating capacity are the combined capacity of the SET FREE system, and is based on EN14511.

Operation condition		Cooling	Heating
Indoor air inlet temperature	DB	27 °C	20 °C
	WB	19 °C	
Outdoor air inlet temperature	DB	35 °C	7 °C
	WB		6 °C

Piping Length: 7.5 meters; piping lift: 0 meters
DB: Dry Bulb; WB: Wet Bulb

2. The sound pressure level is based on following conditions:
 - 1 meter from the frontal surface of the unit.
 - 1.5 meters from floor level.
 - Voltage of the power source is 230V

The above data was measured in an anechoic chamber, so reflected sound should be taken into consideration when installing the unit.

The sound pressure data is based on the cooling mode. In case of heating mode, the sound pressure level increases by approximately 1 or 2 dB.

3. COP and EER data correspond to Outdoor unit (Indoor unit input power is not considered). Outdoor unit performance has been established in 100% combination with RCI-FSN2E model.

2.1.4. General data for RAS-44~48FSN2



RAS MODEL		RAS-44FSN2	RAS-46FSN2	RAS-48FSN2	
Electrical power supply		3~,380/415V, 50Hz			
Nominal cooling capacity	kW	124.0	150.0	135.0	
Nominal heating capacity	kW	138.0	145.0	150.0	
Energy efficiency in cooling mode (EER)		3.56	3.49	3.44	
Energy efficiency coefficient in heating mode (COP)		4.10	4.01	3.97	
Color (Munsell code)	-	Natural gray (1.0Y 8.5/0.5)			
Sound pressure level (night mode)	dB(A)	64 (59)	64 (59)	64 (59)	
Sound power level	dB(A)	To be informed later			
External dimensions	Height	mm	1,670	1,670	
	Width	mm	3,870	3,870	
	Depth	mm	830	830	
Net weight	Kg	1,080	1,080	1,080	
Refrigerant	-	R410A			
Flow control	-	Micro-computer control expansion valve			
Compressor	-	Hermetic (scroll)			
Q'ty	-	1+1x4	1+1x4	1+1x4	
	Power	kW	3.60+6.50x4	4.80+6.50x4	6.00+6.50x4
Heat exchanger		Multi-pass cross-finned tube			
Outdoor fan	-	Propeller fan			
Q'ty	-	4	4	4	
	Air flow rate	m³/min	170x2+160x2	170x2+160x2	170x2+160x2
	Power	W	380x2+570x2	380x2+570x2	380x2+570x2
Refrigerant pipe connection		Flare-nut connection (with flare nuts)			
Size	Liquid piping	mm (in)	ø19.05-ø22.2 (3/4)-(7/8)	ø19.05-ø22.2 (3/4)-(7/8)	ø19.05-ø22.2 (3/4)-(7/8)
	Gas piping	mm (in)	ø38.1-ø41.3 (1-1/2)-(1-5/8)	ø38.1-ø41.3 (1-1/2)-(1-5/8)	ø38.1-ø41.3 (1-1/2)-(1-5/8)
Refrigerant charge	Kg	35.0	35.0	35.0	
Maximum electrical current	A	79.0	84.0	89.0	
Packaging measurements	m³	6.49	6.49	6.49	

i NOTE:

1. The nominal cooling and heating capacity are the combined capacity of the SET FREE system, and is based on EN14511.

Operation condition		Cooling	Heating
Indoor air inlet temperature	DB	27 °C	20 °C
	WB	19 °C	
Outdoor air inlet temperature	DB	35 °C	7 °C
	WB		6 °C

Piping Length: 7.5 meters; piping lift: 0 meters
DB: Dry Bulb; WB: Wet Bulb

2. The sound pressure level is based on following conditions:

- 1 meter from the frontal surface of the unit.
1.5 meters from floor level.
- Voltage of the power source is 230V

The above data was measured in an anechoic chamber, so reflected sound should be taken into consideration when installing the unit.

The sound pressure data is based on the cooling mode. In case of heating mode, the sound pressure level increases by approximately 1 or 2 dB.

3. COP and EER data correspond to Outdoor unit (Indoor unit input power is not considered). Outdoor unit performance has been established in 100% combination with RCI-FSN2E model.

2.2. Component data for RAS-FSN2 units



2.2.1. Fan and heat exchanger of RAS-8~12FSN2

RAS Model			RAS-8FSN2	RAS-10FSN2	RAS-12FSN2	
Heat exchanger	Type	-	Multi-pass cross-finned tube			
	Piping	Material	Copper tube			
		Outer diameter	Ø mm	7.0	7.0	7.0
		Rows	-	3	3	3
		Number of tubes/coil	-	174	174	174
	Fin	Material	Aluminium			
		Pitch	mm	1.9	1.9	1.9
	Maximum operation pressure	MPa	4.15	4.15	4.15	
	Total face area	m ²	2.15	2.15	2.15	
	Number of coils/unit	-	1	1	1	
Fan unit	Fan	Type	Large diameter fan (Propeller fan)			
		Number/unit	-	1	1	1
		Outer diameter	mm	710	710	710
		Revolutions	rpm	555	660	705
		Nominal air flow/fan	m ³ /min	138	172	185
	Motor	Type	Drip-proof type enclosure			
		Starting method	DC Motor			
		Power (pole)	W	380(8)	380(8)	380(8)
		Q'ty	-	1	1	1
		Insulation class	-	E	E	E
Compressor	Inverter type	-	E656DHD	E656DHD	E656DHD	

2

2.2.2. Fan and heat exchanger of RAS-14~24FSN2



RAS Model			RAS-14FSN2	RAS-16FSN2	RAS-18FSN2	RAS-20FSN2	RAS-22FSN2	RAS-24FSN2	
Heat exchanger	Type	-	Multi-pass cross-finned tube						
	Piping	Material	Copper tube						
		Outer diameter	Ø mm	7.0	7.0	7.0	7.0	7.0	7.0
		Rows	-	3	3	3	3	3	3
		Number of tubes/coil	-	174	174	174	174	174	174
	Fin	Material	Aluminium						
		Pitch	mm	1.9	1.9	1.9	1.9	1.9	1.9
	Maximum operation pressure	MPa	4.15	4.15	4.15	4.15	4.15	4.15	
	Total face area	m ²	1.66+1.97	1.66+1.97	1.66+1.97	1.66+1.97	1.66+1.97	1.66+1.97	
	Number of coils/unit	-	1+1	1+1	1+1	1+1	1+1	1+1	
Fan unit	Fan	Type	Large diameter (Propeller fan)						
		Number/unit	-	2	2	2	2	2	2
		Outer diameter	mm	710	710	710	710	710	710
		Revolutions	rpm	585+525	585+525	720+675	720+675	720+675	720+675
		Nominal air flow/fan	m ³ /min	130+140	130+140	185+175	185+175	175+175	185+175
	Motor	Type	Drip-proof type enclosure						
		Starting method	DC Motor						
		Power (pole)	W	380(8)x2	380(8)x2	380(8)x2	380(8)x2	380(8)x2	380(8)x2
		Q'ty	-	2	2	2	2	2	2
		Insulation class	-	E	E	E	E	E	E
Compressor	Inverter type	-	E656DHD+ E656DH	E656DHD+ E656DH	E656DHD+ E656DHx2	E656DHD+ E656DHx2+	E656DHD+ E656DH+ E1000GH	E656DHD+ E656DH+ E1000GH	



2.2.3. Fan and heat exchanger of RAS-26~32FSN2

RAS Model			RAS-26FSN2	RAS-28FSN2	RAS-30FSN2	RAS-32FSN2	
Heat exchanger	Type	-	Multi-pass cross finned tube				
	Piping	Material	-	Copper tube			
		Outer diameter	Ø mm	7.0	7.0	7.0	7.0
		Rows	-	3	3	3	3
		Number of tubes/coil	-	174	174	174	174
	Fin	Material	-	Aluminium			
		Pitch	mm	1.9	1.9	1.9	1.9
	Maximum operation pressure	MPa	4.15	4.15	4.15	4.15	
	Total face area	m ²	1.66+1.85+1.97	1.66+1.85+1.97	1.66+1.85+1.97	1.66+1.85+1.97	
	Number of coils/unit	-	1+1+1	1+1+1	1+1+1	1+1+1	
Fan unit	Fan	Type	-	Large diameter fan (Propeller fan)			
		Number/unit	-	3	3	3	3
		Outer diameter	mm	710	710	710	710
		Revolutions	rpm	600+650+555	600+650+555	600+650+555	600+650+555
		Nominal air flow/fan	m ³ /min	185+175+165	185+175+165	185+175+165	185+175+165
	Motor	Type	-	Drip-proof type enclosure			
		Starting method	-	DC Motor + PSC (Permanent split capacitor)			
		Power (pole)	W	380(8)x2+570(8)	380(8)x2+570(8)	380(8)x2+570(8)	380(8)x2+570(8)
		Q'ty	-	3	3	3	3
		Insulation class	-	Ex2+F	Ex2+F	Ex2+F	Ex2+F
Compressor	Inverter type	-	E656DHD+E1000GHx2	E656DHD+E1000GHx2	E656DHD+E656DH+E1000GHx2	E656DHD+E656DH+E1000GHx2	



2.2.4. Fan and heat exchanger of RAS-34~42FSN2

RAS Model			RAS-34FSN2	RAS-36FSN2	RAS-38FSN2	RAS-40FSN2	RAS-42FSN2	
Heat exchanger	Type	-	Multi-pass cross finned tube					
	Piping	Material	-	Copper tube				
		Outer diameter	Ø mm	7.0	7.0	7.0	7.0	7.0
		Rows	-	3	3	3	3	3
		Number of tubes/coil	-	174	174	174	174	174
	Fin	Material	-	Aluminium				
		Pitch	mm	1.9	1.9	1.9	1.9	1.9
	Maximum operation pressure	MPa	4.15	4.15	4.15	4.15	4.15	
	Total face area	m ²	1.66+1.85+1.97	1.66+1.85+1.97	1.66+1.85+1.97	1.66+1.85+1.97	1.66+1.85+1.97	
	Number of coils/unit	-	1+1+1	1+1+1	1+1+1	1+1+1	1+1+1	
Fan unit	Fan	Type	-	Large diameter fan (Propeller fan)				
		Number/unit	-	3	3	3	3	3
		Outer diameter	mm	710	710	710	710	710
		Revolutions	rpm	810+650+765				
		Nominal air flow/fan	m ³ /min	210+200+172	210+200+172	210+200+172	210+200+172	210+200+172
	Motor	Type	-	Drip-proof type enclosure				
		Starting method	-	DC Motor + PSC (Permanent split capacitor)				
		Power (pole)	W	380+570+380	380+570+380	380+570+380	380+570+380	380+570+380
		Q'ty	-	3	3	3	3	3
		Insulation class	-	Ex2+F	Ex2+F	Ex2+F	Ex2+F	Ex2+F
Compressor	Inverter type	-	E656DHD+E656DH+E1000GHx2	E656DHD+E656DH+E1000GHx2	E656DHD+E656DH+E1000GHx3	E656DHD+E656DH+E1000GHx3	E656DHD+E656DH+E1000GHx3	



2.2.5. Fan and heat exchanger of RAS-44~48FSN2

2

RAS Model			RAS-44FSN2	RAS-46FSN2	RAS-48FSN2	
Heat exchanger	Type	-	Multi-pass cross finned tube			
	Piping	Material	-	Copper tube		
		Outer diameter	Ø mm	7.0	7.0	7.0
		Rows	-	3	3	3
		Number of tubes/coil	-	174	174	174
	Fin	Material	-	Aluminum		
		Pitch	mm	1.9	1.9	1.9
	Maximum operation pressure	MPa	4.15	4.15	4.15	
	Total face area	m ²	1.66+1.85+1.66+1.97	1.66+1.85+1.66+1.97	1.66+1.85+1.66+1.97	
	Number of coils/unit	-	1+1+1+1	1+1+1+1	1+1+1+1	
Fan unit	Fan	Type	-	Large diameter fan (propeller fan)		
		Number/unit	-	4	4	4
		Outer diameter	mm	710	710	710
		Revolutions	rpm	765+650+585+650	765+650+585+650	765+650+585+650
		Nominal air flow/fan	m ³ /min	170+160+170+160	170+160+170+160	170+160+170+160
	Motor	Type	-	Drip-proof type enclosure		
		Starting method	-	DC Motor + PSC (Permanent split capacitor)		
		Power (pole)	W	380(8)x2+570(8)x2	380(8)x2+570(8)x2	380(8)x2+570(8)x2
		Q'ty	-	4	4	4
		Insulation class	-	Ex2+Fx2	Ex2+Fx2	Ex2+Fx2
Compressor	Inverter type	-	E656DHD+E1000GHx4	E656DHD+E1000GHx4	E656DHD+E1000GHx4	

2.3. Component data for compressor



Compressor Model			E656DHD	E656DH	E1000GH
Compressor type	-	-	Hermetic Scroll Type		
Pressure resistance	Discharge	MPa	4.15	4.15	4.15
	Suction	MPa	2.21		
Motor	Starting method	-	Inverter-Driven	Direct-on-line	
	Poles	-	4	2	2
	Insulation class	-	E		
Oil type	-	FVC68D			
Load amount	liters	-	1.1	1.1	1.8

3. Dimensional Data

This chapter shows the dimensions and minimum space required to install each unit of SET FREE FSN2 Series.

Contents

Contenido

3. Dimensional Data	69
3.1. Dimensional data for RAS-8~12FSN2.....	70
3.2. Dimensional data for RAS-14~24FSN2.....	71
3.3. Dimensional data for RAS-26~42FSN2.....	72
3.4. Dimensional data for RAS-44~48FSN2.....	73

3.1. Dimensional data for RAS-8~12FSN2

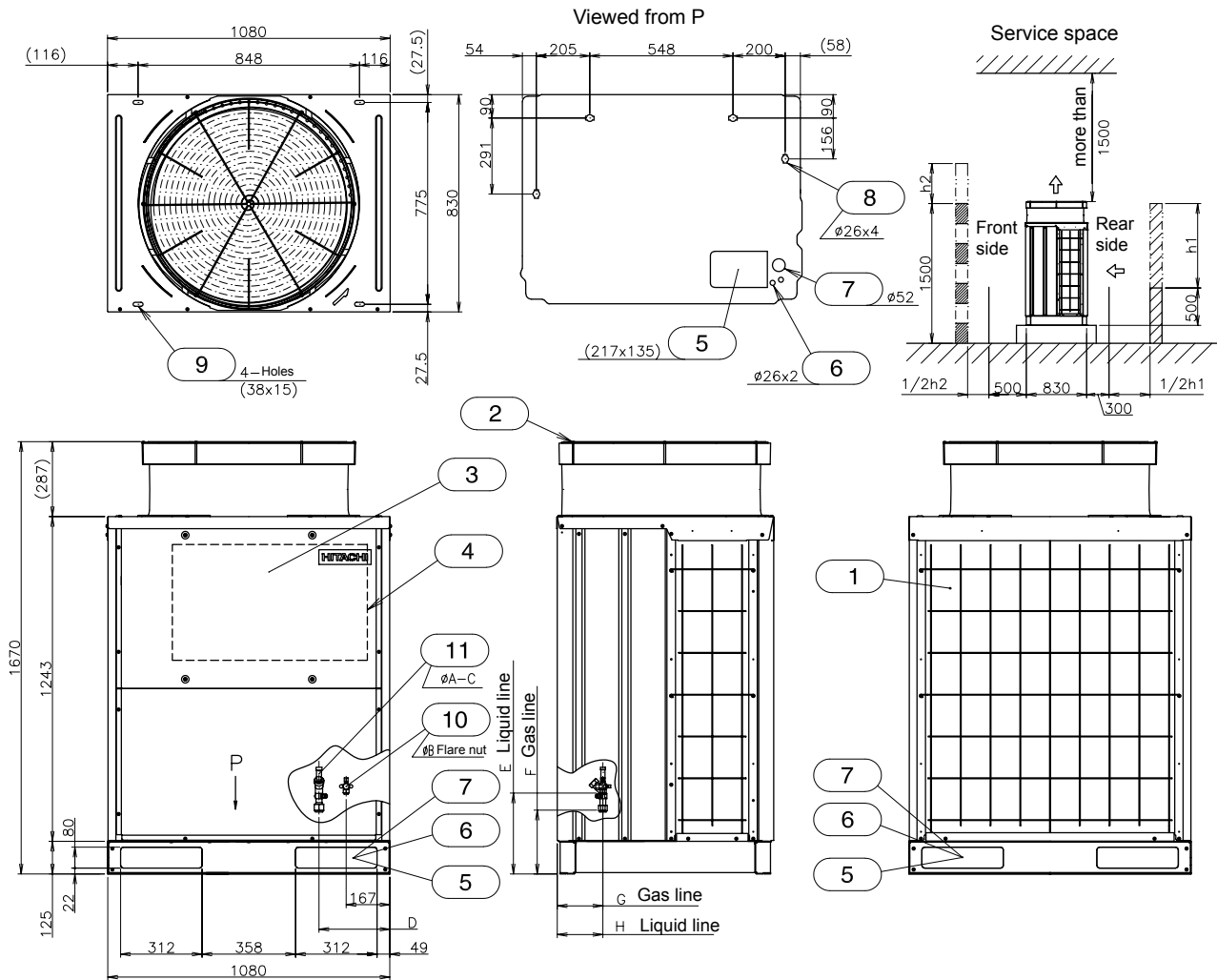

Models	A	B	C	D	E	F	G	H
RAS-8FSN2	19.05	9.53	Flare nut	271	310	244	175	175
RAS-10FSN2	22.20	9.53	Flange	257	310	258	170	175
RAS-12FSN2	25.40	12.70	Flange	257	291	258	170	174

Units: mm

No.	Item	Remarks
1	Air intake	
2	Air outlet	
3	Service cover	
4	Electrical switch box	
5	Holes for refrigerant piping	
6	Holes for control line wiring	
7	Holes for power supply wiring	
8	Drain holes	4-Ø26
9	Holes for fixing machine to floor	4- Holes (38x15)
10	Refrigerant liquid line	Flare nut: ØB
11	Refrigerant gas line	ØA-C



3.2. Dimensional data for RAS-14~24FSN2

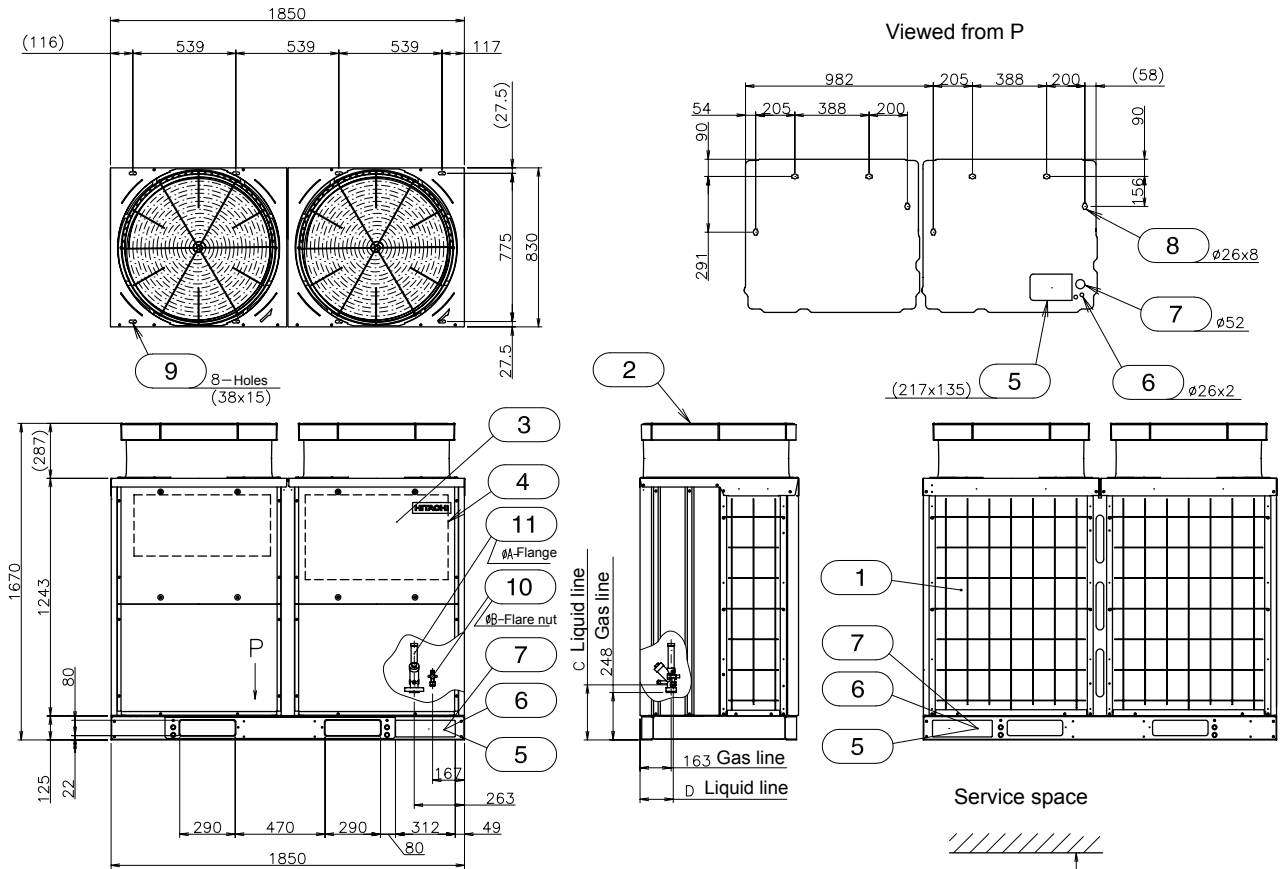

Models	A	B	C	D
RAS-14FSN2	25.4	12.7	288	174
RAS-16FSN2	28.6	12.7	288	174
RAS-18~24FSN2	28.6	15.88	282	170

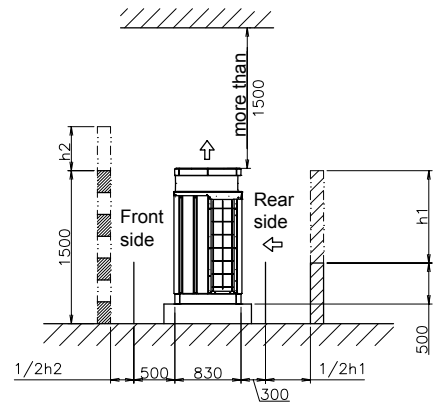

Units: mm

No.	Item	Remarks
1	Air intake	
2	Air outlet	
3	Service cover	
4	Electrical switch box	
5	Holes for refrigerant piping	
6	Holes for control line wiring	
7	Holes for power supply wiring	
8	Drain holes	8-Ø26
9	Holes for fixing machine to floor	8- Holes (38x15)
10	Refrigerant liquid line	Flare nut: ØB
11	Refrigerant gas line	ØA-Flange



3.3. Dimensional data for RAS-26~42FSN2

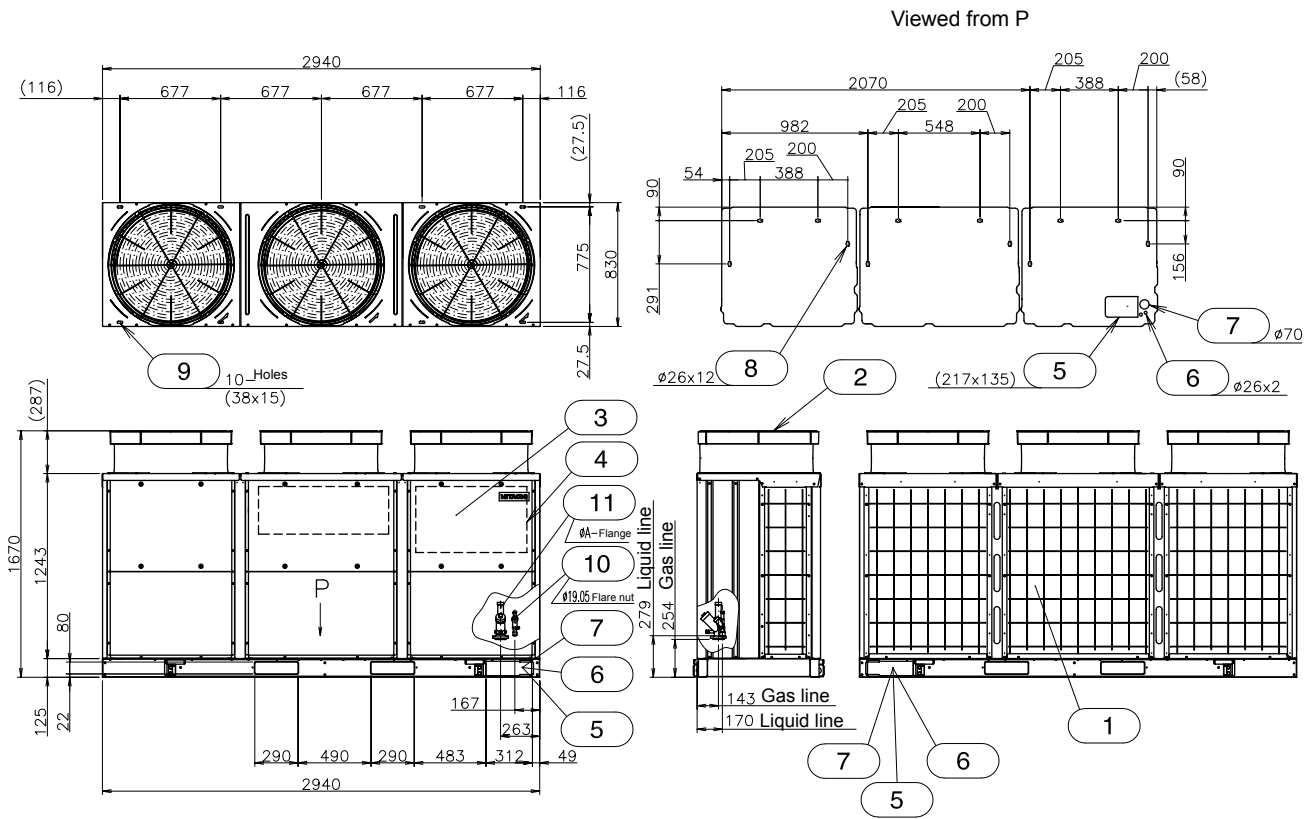

Models	A
RAS-26~34FSN2	31.75 (1-1/4")
RAS-36~42FSN2	38.10 (1-1/2")

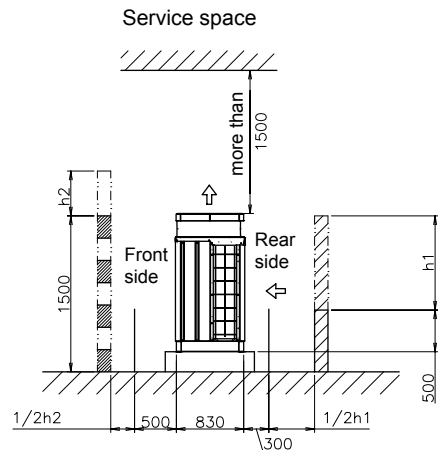

Units: mm

No.	Item	Remarks
1	Air intake	
2	Air outlet	
3	Service cover	
4	Electrical switch box	
5	Holes for refrigerant piping	
6	Holes for control line wiring	
7	Holes for power supply wiring	
8	Drain holes	12-Ø26
9	Holes for fixing machine to floor	10- Holes (38x15)
10	Refrigerant liquid line	Flare nut: ø19.05
11	Refrigerant gas line	ØA-Flange



3.4. Dimensional data for RAS-44~48FSN2

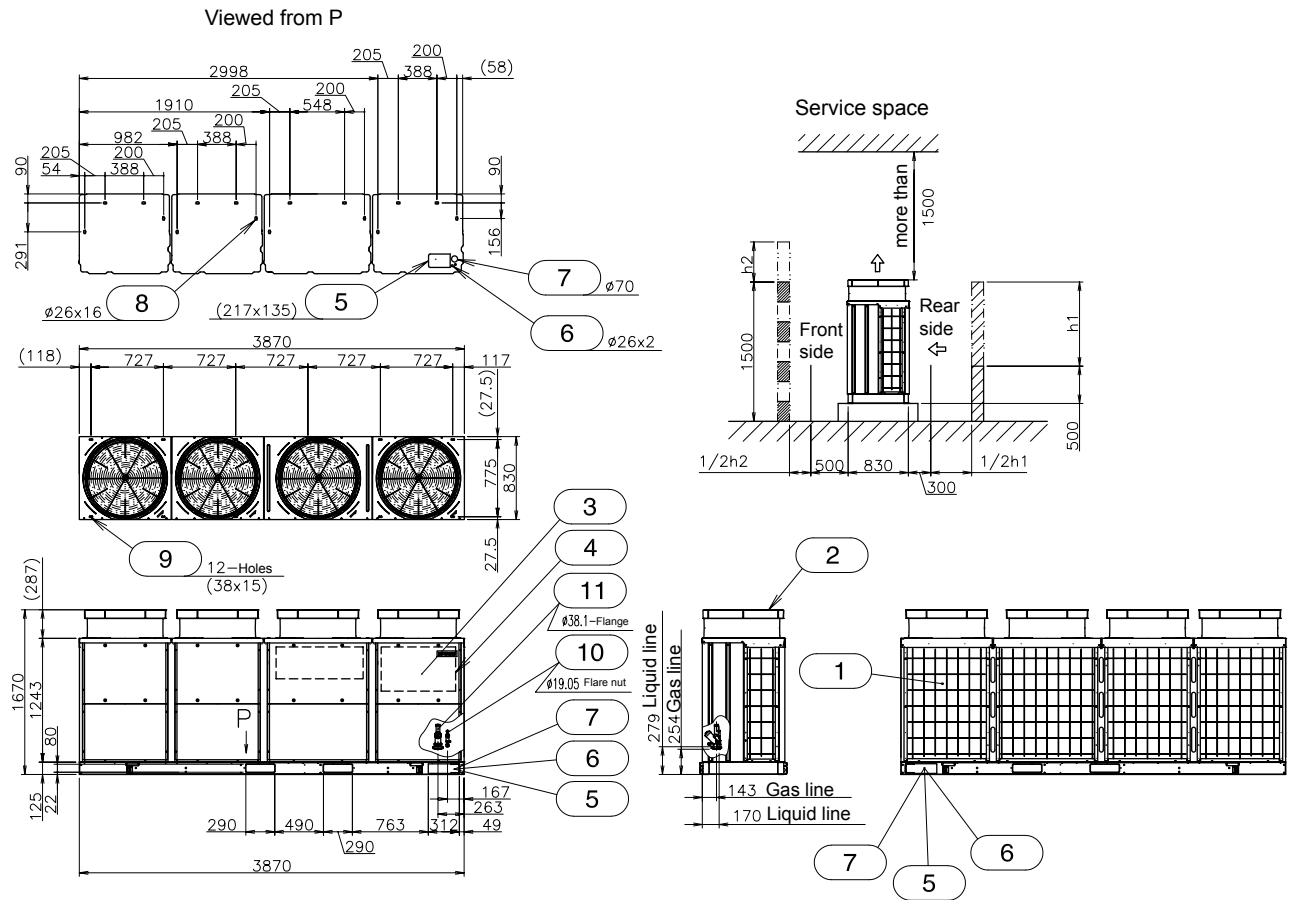

3

Units: mm

No.	Item	Remarks
1	Air intake	
2	Air outlet	
3	Service cover	
4	Electrical switch box	
5	Holes for refrigerant piping	
6	Holes for control line wiring	
7	Holes for power supply wiring	
8	Drain holes	16-Ø26
9	Holes for fixing machine to floor	12- Holes (38x15)
10	Refrigerant liquid line	Flare nut: Ø19.05
11	Refrigerant gas line	Ø38.1-Flange



4. Capacities and Selection Data

This chapter offers a summary of capacities and selection data of the SET FREE FSN2 Series.

Contents

4. Capacities and Selection Data	75
4.1. Selection guide	76
4.2. Outdoor unit capacity with total horsepower of combined indoor unit	80
4.3. Capacity characteristic curve.....	106
4.4. Nominal cooling capacity tables (100% combination)	117
4.5. Nominal heating capacity tables (100% combination).....	121
4.6. Correction factors	128
4.6.1. Piping length correction factor.....	128
4.6.2. Defrost correction factor.....	130
4.7. Sensible heat factor (SHF)	131
4.8. Sound data	132

4.1. Selection guide

◆ Meaning of model name of indoor unit

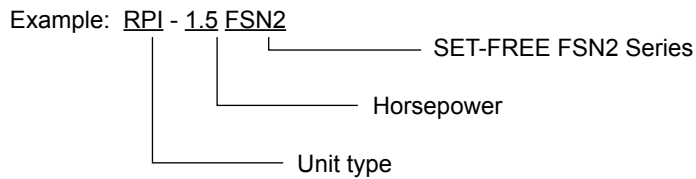

In-the-ceiling type	RPI(M)
4-way cassette type	RCI(M)
2-way cassette type	RCD
Wall type	RPK
Floor type	RPF
Floor concealed type	RPFI
Ceiling type	RPC



NOTE:

Select the indoor units and outdoor unit so as the total indoor horsepower is near to the outdoor horsepower.

◆ Nominal capacity of indoor units

Horsepower (HP)		0.8	1.0	1.5	2.0	2.5	3.0	4.0	5.0	6.0	8.0	10.0
Capacity												
Cooling capacity	kW	2.2	2.8	4.0	5.6	7.1	8.0	11.2	14.0	16.0	22.4	28.0
Heating capacity	kW	2.5	3.2	4.8	6.3	8.5	9.0	12.5	16.0	18.0	25.0	31.5

Capacity adjustment by dip switch setting

Horsepower (HP)	1.3		1.8		2.3	
Variable capacity	1.3	← 1.5	1.8	← 2.0	2.3	← 2.5
Cooling capacity	kW 3.8		5.2		6.7	
Heating capacity	kW 4.2		5.6		7.5	
Applicable model	RPI(M), RCI(M), RCD, RPK, RPF, RPFI		RPI, RCI, RCD, RPK, RPC, RPF, RPFI		RPI, RCI, RCD, RPK, RPC, RPF, RPFI	
Indoor unit dip switch setting (DSW3)	1.3HP ← 1.5HP		1.8HP ← 2.0HP		2.3HP ← 2.5HP	
	 Lowered Standard	 Lowered Standard	 Lowered Standard			

◆ **Meaning of model name of outdoor unit**

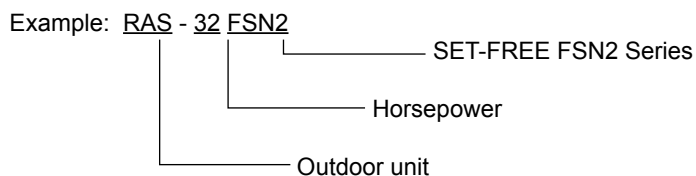

◆ **Nominal capacity of outdoor unit**

Model	RAS-8FSN2	RAS-10FSN2	RAS-12FSN2	RAS-14FSN2	RAS-16FSN2	RAS-18FSN2	RAS-20FSN2
Horsepower (HP)	8	10	12	14	16	18	20
Cooling capacity	kW 22.4	28.0	33.5	40.0	45.0	50.4	56.0
Heating capacity	kW 25.0	31.5	37.5	45.0	50.0	56.0	63.0

Model	RAS-22FSN2	RAS-24FSN2	RAS-26FSN2	RAS-28FSN2	RAS-30FSN2	RAS-32FSN2	RAS-34FSN2
Horsepower (HP)	22	24	26	28	30	32	34
Cooling capacity	kW 63.0	69.0	73.0	80.0	85.0	90.0	96.0
Heating capacity	kW 71.0	77.5	82.5	90.0	95.0	100.0	108.0

Model	RAS-36FSN2	RAS-38FSN2	RAS-40FSN2	RAS-42FSN2	RAS-44FSN2	RAS-46FSN2	RAS-48FSN2
Horsepower (HP)	36	38	40	42	44	46	48
Cooling capacity	kW 101.0	107.0	113.0	118.0	124.0	130.0	135.0
Heating capacity	kW 113.0	119.5	127.0	132.0	138.0	145.0	150.0

Nominal capacity of outdoor unit is under the condition that the total indoor unit horsepower is same as outdoor unit horsepower.

◆ **Outdoor unit capacity at nominal temperature**

If the total indoor unit horsepower is not same to the outdoor unit horsepower, refer to "Capacity characteristic curve" in this chapter.

4

◆ Given condition (Example)

Total load for each room

Item		Room (1)	Room (2)	Room (3)	Room (4)
Estimated cooling load	kW	4.24	5.35	5.35	6.36
Estimated heating load	kW	4.77	6.00	6.00	7.16

Item		Room (5)	Room (6)	Room (7)
Estimated cooling load	kW	8.48	10.6	10.6
Estimated heating load	kW	9.54	11.9	11.9

Temperature condition

Cooling	Heating
Outdoor coil air inlet: 30 °C DB	Outdoor coil air inlet: 1/0 °C (DB/WB)
Indoor coil air inlet: 27/19 °C (DB/WB)	Indoor coil air inlet: 20 °C DB

Equivalent piping length between indoor units and outdoor unit: 60m

Piping lift: 20m

(Gas piping size: Normal, refer to "Piping length correction factor" in this chapter)

Correction factor of cooling capacity = 0.90

Correction factor of heating capacity = 0.96

Power source: 50Hz

◆ Selecting matching indoor units and nominal capacity

Select in-the-ceiling type indoor units (Example)

Item		Room (1)	Room (2)	Room (3)	Room (4)	Room (5)
Selected model		RPI-2.0FSN2	RPI-2.5FSN2	RPI-2.5FSN2	RPI-3.0FSN2	RPI-4.0FSN2
Nominal cooling capacity	kW	5.6	7.1	7.1	8.0	11.2
Nominal heating capacity	kW	6.3	8.5	8.5	9.0	12.5

Item		Room (6)	Room (7)	(1)+(2)+(3)+(4) +(5)+(6)+(7)	Outdoor unit
Selected model		RPI-5.0FSN2	RPI-5.0FSN2	-	RAS-20FSN2
Nominal cooling capacity	kW	14.0	14.0	67.0	56.0
Nominal heating capacity	kW	16.0	16.0	76.8	63.0

◆ Actual capacity

In the case of the example, the total indoor horsepower is 24HP (=2.0HP+2.5HP×2+3.0HP+4.0HP+5.0HP×2).

Therefore, the outdoor unit capacity at the nominal temperature which is selected from the "Capacity characteristic curve" is 57.9 kW at the cooling operation, 64.3 kW at the heating operation under nominal conditions.

a) Actual capacity of outdoor unit

Maximum actual capacity of outdoor unit

$$= [\text{Outdoor unit capacity at nominal temperature} \\ \times \text{Correction factor according to total indoor unit capacity} \\ \times \text{Piping length correction factor} \\ \times \text{Correction factor according to temperature condition}]$$

Refer to "Nominal heating/cooling capacity tables" for correction factor according to the temperature condition.

$$\text{Cooling: } 57.9 \text{ kW} \times 0.90 \times 1.00 = 52.1 \text{ kW}$$

$$\text{Heating: } 64.3 \text{ kW} \times 0.96 \times 0.90 = 55.6 \text{ kW}$$

b) Actual capacity of each indoor unit

Actual capacity of each indoor unit

$$= \text{Actual capacity of outdoor unit} \times [\text{Each indoor unit's horsepower} \div \text{Summation of each indoor unit horsepower}]$$

ex.

<RPI-2.0>

$$\text{Cooling capacity: } 52.1 \times (2.0[\text{HP}] \div (2.0[\text{HP}] + 2.5[\text{HP}] \times 2 + 3.0[\text{HP}] + 4.0[\text{HP}] + 5.0[\text{HP}] \times 2)) = 4.34 \text{ kW}$$

$$\text{Heating capacity: } 55.6 \times (2.0[\text{HP}] \div (2.0[\text{HP}] + 2.5[\text{HP}] \times 2 + 3.0[\text{HP}] + 4.0[\text{HP}] + 5.0[\text{HP}] \times 2)) = 4.63 \text{ kW}$$

<RPI-2.5>

$$\text{Cooling capacity: } 52.1 \times (2.5[\text{HP}] \div (2.0[\text{HP}] + 2.5[\text{HP}] \times 2 + 3.0[\text{HP}] + 4.0[\text{HP}] + 5.0[\text{HP}] \times 2)) = 5.43 \text{ kW}$$

$$\text{Heating capacity: } 55.6 \times (2.5[\text{HP}] \div (2.0[\text{HP}] + 2.5[\text{HP}] \times 2 + 3.0[\text{HP}] + 4.0[\text{HP}] + 5.0[\text{HP}] \times 2)) = 5.79 \text{ kW}$$

<RPI-3.0>

$$\text{Cooling capacity: } 52.1 \times (3.0[\text{HP}] \div (2.0[\text{HP}] + 2.5[\text{HP}] \times 2 + 3.0[\text{HP}] + 4.0[\text{HP}] + 5.0[\text{HP}] \times 2)) = 6.51 \text{ kW}$$

$$\text{Heating capacity: } 55.6 \times (3.0[\text{HP}] \div (2.0[\text{HP}] + 2.5[\text{HP}] \times 2 + 3.0[\text{HP}] + 4.0[\text{HP}] + 5.0[\text{HP}] \times 2)) = 6.95 \text{ kW}$$

<RPI-4.0>

$$\text{Cooling capacity: } 52.1 \times (4.0[\text{HP}] \div (2.0[\text{HP}] + 2.5[\text{HP}] \times 2 + 3.0[\text{HP}] + 4.0[\text{HP}] + 5.0[\text{HP}] \times 2)) = 8.68 \text{ kW}$$

$$\text{Heating capacity: } 55.6 \times (4.0[\text{HP}] \div (2.0[\text{HP}] + 2.5[\text{HP}] \times 2 + 3.0[\text{HP}] + 4.0[\text{HP}] + 5.0[\text{HP}] \times 2)) = 9.27 \text{ kW}$$

<RPI-5.0>

$$\text{Cooling capacity: } 52.1 \times (5.0[\text{HP}] \div (2.0[\text{HP}] + 2.5[\text{HP}] \times 2 + 3.0[\text{HP}] + 4.0[\text{HP}] + 5.0[\text{HP}] \times 2)) = 10.85 \text{ kW}$$

$$\text{Heating capacity: } 55.6 \times (5.0[\text{HP}] \div (2.0[\text{HP}] + 2.5[\text{HP}] \times 2 + 3.0[\text{HP}] + 4.0[\text{HP}] + 5.0[\text{HP}] \times 2)) = 11.58 \text{ kW}$$

< Result >

Item			Room (1)	Room (2)	Room (3)	Room (4)
Selected model			RPI-2.0	RPI-2.5	RPI-2.5	RPI-3.0
Actual capacity	Actual cooling capacity	kW	4.34	5.43	5.43	6.51
	Actual heating capacity	kW	4.63	5.79	5.79	6.95
Design load	Estimated cooling load	kW	4.24	5.35	5.35	6.36
	Estimated heating load	kW	4.77	6.00	6.00	7.16

Item			Room (5)	Room (6)	Room (7)	(1)+(2)+(3)+(4) +(5)+(6)+(7)
Selected model			RPI-4.0	RPI-5.0	RPI-5.0	-
Actual capacity	Actual cooling capacity	kW	8.68	10.85	10.85	52.09
	Actual heating capacity	kW	9.27	11.58	11.58	55.59
Design load	Estimated cooling load	kW	8.48	10.6	10.6	50.98
	Estimated heating load	kW	9.54	11.9	11.9	57.27

4.2. Outdoor unit capacity with total horsepower of combined indoor unit

The following tables show the examples of outdoor unit capacity which corresponds with total horsepower of combined indoor unit, according to the charts of "Capacity characteristic curve".

◆ RAS-8~18FSN2

Total (HP)	Outdoor unit capacity (kW)											
	RAS-8FSN2		RAS-10FSN2		RAS-12FSN2		RAS-14FSN2		RAS-16FSN2		RAS-18FSN2	
	Cooling	Heating	Cooling	Heating	Cooling	Heating	Cooling	Heating	Cooling	Heating	Cooling	Heating
4.0	11.20	12.50										
4.1	11.48	12.81										
4.2	11.76	13.13										
4.3	12.04	13.44										
4.4	12.32	13.75										
4.5	12.60	14.06										
4.6	12.88	14.38										
4.7	13.16	14.69										
4.8	13.44	15.00										
4.9	13.72	15.31										
5.0	14.00	15.63	14.00	15.80								
5.1	14.28	15.94	14.28	16.11								
5.2	14.56	16.25	14.56	16.43								
5.3	14.84	16.56	14.84	16.74								
5.4	15.12	16.88	15.12	17.06								
5.5	15.40	17.19	15.40	17.37								
5.6	15.68	17.50	15.68	17.68								
5.7	15.96	17.81	15.96	18.00								
5.8	16.24	18.13	16.24	18.31								
5.9	16.52	18.44	16.52	18.63								
6.0	16.80	18.75	16.80	18.94	16.80	18.80						
6.1	17.08	19.06	17.08	19.25	17.08	19.11						
6.2	17.36	19.38	17.36	19.57	17.36	19.42						
6.3	17.64	19.69	17.64	19.88	17.64	19.74						
6.4	17.92	20.00	17.92	20.20	17.91	20.05						
6.5	18.20	20.31	18.20	20.51	18.19	20.36						
6.6	18.48	20.63	18.48	20.82	18.47	20.67						
6.7	18.76	20.94	18.76	21.14	18.75	20.98						
6.8	19.04	21.25	19.04	21.45	19.03	21.29						
6.9	19.32	21.56	19.32	21.77	19.31	21.61						
7.0	19.60	21.87	19.60	22.08	19.58	21.92	20.00	22.50				
7.1	19.88	22.19	19.88	22.39	19.86	22.23	20.29	22.82				
7.2	20.16	22.50	20.16	22.71	20.14	22.54	20.57	23.14				
7.3	20.44	22.81	20.44	23.02	20.42	22.85	20.86	23.46				
7.4	20.72	23.12	20.72	23.34	20.70	23.16	21.14	23.79				
7.5	21.00	23.44	21.00	23.65	20.97	23.48	21.43	24.11				
7.6	21.28	23.75	21.28	23.96	21.25	23.79	21.71	24.43				
7.7	21.56	24.06	21.56	24.28	21.53	24.10	22.00	24.75				
7.8	21.84	24.37	21.84	24.59	21.81	24.41	22.29	25.07				
7.9	22.12	24.69	22.12	24.91	22.09	24.72	22.57	25.39				
8.0	22.40	25.00	22.40	25.22	22.37	25.03	22.86	25.71	22.50	25.00		
8.1	22.43	25.10	22.68	25.53	22.64	25.35	23.14	26.04	22.78	25.31		
8.2	22.46	25.21	22.96	25.85	22.92	25.66	23.43	26.36	23.06	25.63		
8.3	22.49	25.31	23.24	26.16	23.20	25.97	23.71	26.68	23.34	25.94		
8.4	22.52	25.42	23.52	26.48	23.48	26.28	24.00	27.00	23.63	26.25		
8.5	22.55	25.52	23.80	26.79	23.76	26.59	24.29	27.32	23.91	26.56		
8.6	22.58	25.62	24.08	27.10	24.04	26.90	24.57	27.64	24.19	26.88		
8.7	22.60	25.73	24.36	27.42	24.31	27.22	24.86	27.96	24.47	27.19		
8.8	22.63	25.83	24.64	27.73	24.59	27.53	25.14	28.29	24.75	27.50		
8.9	22.66	25.94	24.92	28.05	24.87	27.84	25.43	28.61	25.03	27.81		

Total (HP)	Outdoor unit capacity (kW)											
	RAS-8FSN2		RAS-10FSN2		RAS-12FSN2		RAS-14FSN2		RAS-16FSN2		RAS-18FSN2	
	Cooling	Heating	Cooling	Heating	Cooling	Heating	Cooling	Heating	Cooling	Heating	Cooling	Heating
9.0	22.69	26.04	25.20	28.36	25.15	28.15	25.71	28.93	25.31	28.13	25.20	28.00
9.1	22.72	26.15	25.48	28.67	25.43	28.46	26.00	29.25	25.59	28.44	25.48	28.31
9.2	22.75	26.25	25.76	28.99	25.71	28.77	26.29	29.57	25.88	28.75	25.76	28.62
9.3	22.78	26.35	26.04	29.30	25.98	29.09	26.57	29.89	26.16	29.06	26.04	28.93
9.4	22.81	26.46	26.32	29.62	26.26	29.40	26.86	30.21	26.44	29.38	26.32	29.24
9.5	22.84	26.56	26.60	29.93	26.54	29.71	27.14	30.54	26.72	29.69	26.60	29.56
9.6	22.87	26.67	26.88	30.24	26.82	30.02	27.43	30.86	27.00	30.00	26.88	29.87
9.7	22.90	26.77	27.16	30.56	27.10	30.33	27.71	31.18	27.28	30.31	27.16	30.18
9.8	22.93	26.88	27.44	30.87	27.38	30.64	28.00	31.50	27.56	30.63	27.44	30.49
9.9	22.95	26.98	27.72	31.19	27.65	30.95	28.29	31.82	27.84	30.94	27.72	30.80
10.0	22.98	27.08	28.00	31.50	27.93	31.27	28.57	32.14	28.13	31.25	28.00	31.11
10.1	23.01	27.19	28.03	31.55	28.21	31.58	28.86	32.46	28.41	31.56	28.28	31.42
10.2	23.04	27.29	28.05	31.61	28.49	31.89	29.14	32.79	28.69	31.88	28.56	31.73
10.3	23.07	27.40	28.08	31.66	28.77	32.20	29.43	33.11	28.97	32.19	28.84	32.04
10.4	23.10	27.50	28.11	31.71	29.05	32.51	29.71	33.43	29.25	32.50	29.12	32.36
10.5			28.13	31.77	29.33	32.83	30.00	33.75	29.53	32.81	29.40	32.67
10.6			28.16	31.82	29.60	33.14	30.29	34.07	29.81	33.13	29.68	32.98
10.7			28.19	31.87	29.88	33.45	30.57	34.39	30.09	33.44	29.96	33.29
10.8			28.21	31.93	30.16	33.76	30.86	34.71	30.38	33.75	30.24	33.60
10.9			28.24	31.98	30.44	34.07	31.14	35.04	30.66	34.06	30.52	33.91
11.0			28.27	32.03	30.72	34.38	31.43	35.36	30.94	34.38	30.80	34.22
11.1			28.29	32.09	31.00	34.70	31.71	35.68	31.22	34.69	31.08	34.53
11.2			28.32	32.14	31.27	35.01	32.00	36.00	31.50	35.00	31.36	34.84
11.3			28.35	32.19	31.55	35.32	32.29	36.32	31.78	35.31	31.64	35.16
11.4			28.37	32.25	31.83	35.63	32.57	36.64	32.06	35.63	31.92	35.47
11.5			28.40	32.30	32.11	35.94	32.86	36.96	32.34	35.94	32.20	35.78
11.6			28.43	32.35	32.39	36.25	33.14	37.29	32.63	36.25	32.48	36.09
11.7			28.45	32.41	32.67	36.57	33.43	37.61	32.91	36.56	32.76	36.40
11.8			28.48	32.46	32.94	36.88	33.71	37.93	33.19	36.88	33.04	36.71
11.9			28.51	32.51	33.22	37.19	34.00	38.25	33.47	37.19	33.32	37.02
12.0			28.53	32.57	33.50	37.50	34.29	38.57	33.75	37.50	33.60	37.33
12.1			28.56	32.62	33.50	37.50	34.57	38.89	34.03	37.81	33.88	37.64
12.2			28.59	32.67	33.50	37.50	34.86	39.21	34.31	38.13	34.16	37.96
12.3			28.61	32.73	33.50	37.50	35.14	39.54	34.59	38.44	34.44	38.27
12.4			28.64	32.78	33.50	37.50	35.43	39.86	34.88	38.75	34.72	38.58
12.5			28.67	32.83	33.50	37.50	35.71	40.18	35.16	39.06	35.00	38.89
12.6			28.69	32.89	33.50	37.50	36.00	40.50	35.44	39.38	35.28	39.20
12.7			28.72	32.94	33.50	37.50	36.29	40.82	35.72	39.69	35.56	39.51
12.8			28.75	32.99	33.50	37.50	36.57	41.14	36.00	40.00	35.84	39.82
12.9			28.77	33.05	33.50	37.50	36.86	41.46	36.28	40.31	36.12	40.13
13.0			28.80	33.10	33.50	37.50	37.14	41.79	36.56	40.63	36.40	40.44
13.1					33.50	37.50	37.43	42.11	36.84	40.94	36.68	40.76
13.2					33.50	37.50	37.71	42.43	37.13	41.25	36.96	41.07
13.3					33.50	37.50	38.00	42.75	37.41	41.56	37.24	41.38
13.4					33.50	37.50	38.29	43.07	37.69	41.88	37.52	41.69
13.5					33.50	37.50	38.57	43.39	37.97	42.19	37.80	42.00
13.6					33.50	37.50	38.86	43.71	38.25	42.50	38.08	42.31
13.7					33.50	37.50	39.14	44.04	38.53	42.81	38.36	42.62
13.8					33.50	37.50	39.43	44.36	38.81	43.13	38.64	42.93
13.9					33.50	37.50	39.71	44.68	39.09	43.44	38.92	43.24
14.0					33.50	37.50	40.00	45.00	39.38	43.75	39.20	43.56

Total (HP)	Outdoor unit capacity (kW)											
	RAS-8FSN2		RAS-10FSN2		RAS-12FSN2		RAS-14FSN2		RAS-16FSN2		RAS-18FSN2	
	Cooling	Heating	Cooling	Heating	Cooling	Heating	Cooling	Heating	Cooling	Heating	Cooling	Heating
14.1					33.50	37.50	40.05	45.05	39.66	44.06	39.48	43.87
14.2					33.50	37.50	40.10	45.11	39.94	44.38	39.76	44.18
14.3					33.50	37.50	40.14	45.16	40.22	44.69	40.04	44.49
14.4					33.50	37.50	40.19	45.22	40.50	45.00	40.32	44.80
14.5					33.50	37.50	40.24	45.27	40.78	45.31	40.60	45.11
14.6					33.50	37.50	40.29	45.33	41.06	45.63	40.88	45.42
14.7					33.50	37.50	40.33	45.38	41.34	45.94	41.16	45.73
14.8					33.50	37.50	40.38	45.44	41.63	46.25	41.44	46.04
14.9					33.50	37.50	40.43	45.49	41.91	46.56	41.72	46.36
15.0					33.50	37.50	40.48	45.55	42.19	46.88	42.00	46.67
15.1					33.50	37.50	40.52	45.60	42.47	47.19	42.28	46.98
15.2					33.50	37.50	40.57	45.66	42.75	47.50	42.56	47.29
15.3					33.50	37.50	40.62	45.71	43.03	47.81	42.84	47.60
15.4					33.50	37.50	40.67	45.77	43.31	48.13	43.12	47.91
15.5					33.50	37.50	40.71	45.82	43.59	48.44	43.40	48.22
15.6					33.50	37.50	40.76	45.88	43.88	48.75	43.68	48.53
15.7							40.81	45.93	44.16	49.06	43.96	48.84
15.8							40.86	45.99	44.44	49.38	44.24	49.16
15.9							40.90	46.04	44.72	49.69	44.52	49.47
16.0							40.95	46.10	45.00	50.00	44.80	49.78
16.1							41.00	46.15	45.05	50.03	45.08	50.09
16.2							41.05	46.20	45.10	50.06	45.36	50.40
16.3							41.10	46.26	45.14	50.09	45.64	50.71
16.4							41.14	46.31	45.19	50.13	45.92	51.02
16.5							41.19	46.37	45.24	50.16	46.20	51.33
16.6							41.24	46.42	45.29	50.19	46.48	51.64
16.7							41.29	46.48	45.34	50.22	46.76	51.96
16.8							41.33	46.53	45.38	50.25	47.04	52.27
16.9							41.38	46.59	45.43	50.28	47.32	52.58
17.0							41.43	46.64	45.48	50.31	47.60	52.89
17.1							41.48	46.70	45.53	50.34	47.88	53.20
17.2							41.52	46.75	45.58	50.38	48.16	53.51
17.3							41.57	46.81	45.62	50.41	48.44	53.82
17.4							41.62	46.86	45.67	50.44	48.72	54.13
17.5							41.67	46.92	45.72	50.47	49.00	54.44
17.6							41.71	46.97	45.77	50.50	49.28	54.76
17.7							41.76	47.03	45.81	50.53	49.56	55.07
17.8							41.81	47.08	45.86	50.56	49.84	55.38
17.9							41.86	47.14	45.91	50.59	50.12	55.69
18.0							41.90	47.19	45.96	50.63	50.40	56.00
18.1							41.95	47.25	46.01	50.66	50.45	56.05
18.2							42.00	47.30	46.05	50.69	50.49	56.10
18.3									46.10	50.72	50.54	56.16
18.4									46.15	50.75	50.59	56.21
18.5									46.20	50.78	50.63	56.26
18.6									46.25	50.81	50.68	56.31
18.7									46.29	50.84	50.72	56.36
18.8									46.34	50.88	50.77	56.41

Total (HP)	Outdoor unit capacity (kW)											
	RAS-8FSN2		RAS-10FSN2		RAS-12FSN2		RAS-14FSN2		RAS-16FSN2		RAS-18FSN2	
	Cooling	Heating	Cooling	Heating	Cooling	Heating	Cooling	Heating	Cooling	Heating	Cooling	Heating
18.9									46.39	50.91	50.82	56.47
19.0									46.44	50.94	50.86	56.52
19.1									46.49	50.97	50.91	56.57
19.2									46.53	51.00	50.96	56.62
19.3									46.58	51.03	51.00	56.67
19.4									46.63	51.06	51.05	56.73
19.5									46.68	51.09	51.09	56.78
19.6									46.73	51.13	51.14	56.83
19.7									46.77	51.16	51.19	56.88
19.8									46.82	51.19	51.23	56.93
19.9									46.87	51.22	51.28	56.99
20.0									46.92	51.25	51.33	57.04
20.1									46.96	51.28	51.37	57.09
20.2									47.01	51.31	51.42	57.14
20.3									47.06	51.34	51.46	57.19
20.4									47.11	51.38	51.51	57.24
20.5									47.16	51.41	51.56	57.30
20.6									47.20	51.44	51.60	57.35
20.7									47.25	51.47	51.65	57.40
20.8									47.30	51.50	51.70	57.45
20.9											51.74	57.50
21.0											51.79	57.56
21.1											51.84	57.61
21.2	-		-		-						51.88	57.66
21.3											51.93	57.71
21.4											51.97	57.76
21.5											52.02	57.81
21.6											52.07	57.87
21.7											52.11	57.92
21.8											52.16	57.97
21.9											52.21	58.02
22.0											52.25	58.07
22.1											52.30	58.13
22.2											52.34	58.18
22.3											52.39	58.23
22.4											52.44	58.28
22.5											52.48	58.33
22.6											52.53	58.39
22.7											52.58	58.44
22.8											52.62	58.49
22.9											52.67	58.54
23.0											52.71	58.59
23.1											52.76	58.64
23.2											52.81	58.70
23.3											52.85	58.75
23.4											52.90	58.80

4

◆ RAS-20~30FSN2

Total	Outdoor unit capacity (kW)											
	RAS-20FSN2		RAS-22FSN2		RAS-24FSN2		RAS-26FSN2		RAS-28FSN2		RAS-30FSN2	
	Cooling	Heating	Cooling	Heating	Cooling	Heating	Cooling	Heating	Cooling	Heating	Cooling	Heating
10.0	28.00	31.50										
10.1	28.28	31.82										
10.2	28.56	32.13										
10.3	28.84	32.45										
10.4	29.12	32.76										
10.5	29.40	33.08										
10.6	29.68	33.39										
10.7	29.96	33.71										
10.8	30.24	34.02										
10.9	30.52	34.34										
11.0	30.80	34.65	31.50	35.50								
11.1	31.08	34.97	31.79	35.82								
11.2	31.36	35.28	32.07	36.15								
11.3	31.64	35.60	32.36	36.47								
11.4	31.92	35.91	32.65	36.79								
11.5	32.20	36.23	32.93	37.11								
11.6	32.48	36.54	33.22	37.44								
11.7	32.76	36.86	33.50	37.76								
11.8	33.04	37.17	33.79	38.08								
11.9	33.32	37.49	34.08	38.40								
12.0	33.60	37.80	34.36	38.73	34.50	38.80						
12.1	33.88	38.12	34.65	39.05	34.79	39.12						
12.2	34.16	38.43	34.94	39.37	35.08	39.45						
12.3	34.44	38.75	35.22	39.70	35.36	39.77						
12.4	34.72	39.06	35.51	40.02	35.65	40.09						
12.5	35.00	39.38	35.80	40.34	35.94	40.41						
12.6	35.28	39.69	36.08	40.66	36.23	40.74						
12.7	35.56	40.01	36.37	40.99	36.51	41.06						
12.8	35.84	40.32	36.65	41.31	36.80	41.38						
12.9	36.12	40.64	36.94	41.63	37.09	41.70						
13.0	36.40	40.95	37.23	41.95	37.38	42.03	36.50	41.30				
13.1	36.68	41.27	37.51	42.28	37.66	42.35	36.78	41.62				
13.2	36.96	41.58	37.80	42.60	37.95	42.67	37.06	41.93				
13.3	37.24	41.90	38.09	42.92	38.24	42.99	37.34	42.25				
13.4	37.52	42.21	38.37	43.25	38.53	43.32	37.62	42.57				
13.5	37.80	42.53	38.66	43.57	38.81	43.64	37.90	42.88				
13.6	38.08	42.84	38.95	43.89	39.10	43.96	38.18	43.20				
13.7	38.36	43.16	39.23	44.21	39.39	44.28	38.47	43.52				
13.8	38.64	43.47	39.52	44.54	39.68	44.61	38.75	43.84				
13.9	38.92	43.79	39.80	44.86	39.96	44.93	39.03	44.15				
14.0	39.20	44.10	40.09	45.18	40.25	45.25	39.31	44.47	40.00	45.00		
14.1	39.48	44.42	40.38	45.50	40.54	45.57	39.59	44.79	40.29	45.32		
14.2	39.76	44.73	40.66	45.83	40.83	45.90	39.87	45.10	40.57	45.64		
14.3	40.04	45.05	40.95	46.15	41.11	46.22	40.15	45.42	40.86	45.96		
14.4	40.32	45.36	41.24	46.47	41.40	46.54	40.43	45.74	41.14	46.29		
14.5	40.60	45.68	41.52	46.80	41.69	46.86	40.71	46.05	41.43	46.61		
14.6	40.88	45.99	41.81	47.12	41.98	47.19	40.99	46.37	41.71	46.93		
14.7	41.16	46.31	42.10	47.44	42.26	47.51	41.27	46.69	42.00	47.25		
14.8	41.44	46.62	42.38	47.76	42.55	47.83	41.55	47.00	42.29	47.57		
14.9	41.72	46.94	42.67	48.09	42.84	48.15	41.83	47.32	42.57	47.89		

Total	Outdoor unit capacity (kW)											
	RAS-20FSN2		RAS-22FSN2		RAS-24FSN2		RAS-26FSN2		RAS-28FSN2		RAS-30FSN2	
	Cooling	Heating	Cooling	Heating	Cooling	Heating	Cooling	Heating	Cooling	Heating	Cooling	Heating
15.0	42.00	47.25	42.95	48.41	43.13	48.48	42.12	47.64	42.86	48.21	42.50	47.50
15.1	42.28	47.57	43.24	48.73	43.41	48.80	42.40	47.96	43.14	48.54	42.78	47.82
15.2	42.56	47.88	43.53	49.05	43.70	49.12	42.68	48.27	43.43	48.86	43.07	48.13
15.3	42.84	48.20	43.81	49.38	43.99	49.44	42.96	48.59	43.71	49.18	43.35	48.45
15.4	43.12	48.51	44.10	49.70	44.28	49.77	43.24	48.91	44.00	49.50	43.63	48.77
15.5	43.40	48.83	44.39	50.02	44.56	50.09	43.52	49.22	44.29	49.82	43.92	49.08
15.6	43.68	49.14	44.67	50.35	44.85	50.41	43.80	49.54	44.57	50.14	44.20	49.40
15.7	43.96	49.46	44.96	50.67	45.14	50.73	44.08	49.86	44.86	50.46	44.48	49.72
15.8	44.24	49.77	45.25	50.99	45.43	51.06	44.36	50.17	45.14	50.79	44.77	50.03
15.9	44.52	50.09	45.53	51.31	45.71	51.38	44.64	50.49	45.43	51.11	45.05	50.35
16.0	44.80	50.40	45.82	51.64	46.00	51.70	44.92	50.81	45.71	51.43	45.33	50.67
16.1	45.08	50.72	46.10	51.96	46.29	52.02	45.20	51.12	46.00	51.75	45.62	50.98
16.2	45.36	51.03	46.39	52.28	46.58	52.35	45.48	51.44	46.29	52.07	45.90	51.30
16.3	45.64	51.35	46.68	52.60	46.86	52.67	45.77	51.76	46.57	52.39	46.18	51.62
16.4	45.92	51.66	46.96	52.93	47.15	52.99	46.05	52.08	46.86	52.71	46.47	51.93
16.5	46.20	51.98	47.25	53.25	47.44	53.31	46.33	52.39	47.14	53.04	46.75	52.25
16.6	46.48	52.29	47.54	53.57	47.73	53.64	46.61	52.71	47.43	53.36	47.03	52.57
16.7	46.76	52.61	47.82	53.90	48.01	53.96	46.89	53.03	47.71	53.68	47.32	52.88
16.8	47.04	52.92	48.11	54.22	48.30	54.28	47.17	53.34	48.00	54.00	47.60	53.20
16.9	47.32	53.23	48.40	54.54	48.59	54.60	47.45	53.66	48.29	54.32	47.88	53.52
17.0	47.60	53.55	48.68	54.86	48.87	54.92	47.73	53.98	48.57	54.64	48.17	53.83
17.1	47.88	53.86	48.97	55.19	49.16	55.25	48.01	54.29	48.86	54.96	48.45	54.15
17.2	48.16	54.18	49.25	55.51	49.45	55.57	48.29	54.61	49.14	55.29	48.73	54.47
17.3	48.44	54.49	49.54	55.83	49.74	55.89	48.57	54.93	49.43	55.61	49.02	54.78
17.4	48.72	54.81	49.83	56.15	50.02	56.21	48.85	55.24	49.71	55.93	49.30	55.10
17.5	49.00	55.12	50.11	56.48	50.31	56.54	49.13	55.56	50.00	56.25	49.58	55.42
17.6	49.28	55.44	50.40	56.80	50.60	56.86	49.42	55.88	50.29	56.57	49.87	55.73
17.7	49.56	55.75	50.69	57.12	50.89	57.18	49.70	56.20	50.57	56.89	50.15	56.05
17.8	49.84	56.07	50.97	57.45	51.17	57.50	49.98	56.51	50.86	57.21	50.43	56.37
17.9	50.12	56.38	51.26	57.77	51.46	57.83	50.26	56.83	51.14	57.54	50.72	56.68
18.0	50.40	56.70	51.55	58.09	51.75	58.15	50.54	57.15	51.43	57.86	51.00	57.00
18.1	50.68	57.02	51.83	58.41	52.04	58.47	50.82	57.46	51.71	58.18	51.28	57.32
18.2	50.96	57.33	52.12	58.74	52.32	58.79	51.10	57.78	52.00	58.50	51.57	57.63
18.3	51.24	57.65	52.40	59.06	52.61	59.12	51.38	58.10	52.29	58.82	51.85	57.95
18.4	51.52	57.96	52.69	59.38	52.90	59.44	51.66	58.41	52.57	59.14	52.13	58.27
18.5	51.80	58.28	52.98	59.70	53.19	59.76	51.94	58.73	52.86	59.46	52.42	58.58
18.6	52.08	58.59	53.26	60.03	53.47	60.08	52.22	59.05	53.14	59.79	52.70	58.90
18.7	52.36	58.91	53.55	60.35	53.76	60.41	52.50	59.36	53.43	60.11	52.98	59.22
18.8	52.64	59.22	53.84	60.67	54.05	60.73	52.78	59.68	53.71	60.43	53.27	59.53
18.9	52.92	59.54	54.12	61.00	54.34	61.05	53.07	60.00	54.00	60.75	53.55	59.85
19.0	53.20	59.85	54.41	61.32	54.62	61.37	53.35	60.32	54.29	61.07	53.83	60.17
19.1	53.48	60.17	54.70	61.64	54.91	61.70	53.63	60.63	54.57	61.39	54.12	60.48
19.2	53.76	60.48	54.98	61.96	55.20	62.02	53.91	60.95	54.86	61.71	54.40	60.80
19.3	54.04	60.80	55.27	62.29	55.49	62.34	54.19	61.27	55.14	62.04	54.68	61.12
19.4	54.32	61.11	55.55	62.61	55.77	62.66	54.47	61.58	55.43	62.36	54.97	61.43
19.5	54.60	61.43	55.84	62.93	56.06	62.99	54.75	61.90	55.71	62.68	55.25	61.75
19.6	54.88	61.74	56.13	63.25	56.35	63.31	55.03	62.22	56.00	63.00	55.53	62.07
19.7	55.16	62.06	56.41	63.58	56.64	63.63	55.31	62.53	56.29	63.32	55.82	62.38
19.8	55.44	62.37	56.70	63.90	56.92	63.95	55.59	62.85	56.57	63.64	56.10	62.70
19.9	55.72	62.69	56.99	64.22	57.21	64.28	55.87	63.17	56.86	63.96	56.38	63.02

Total	Outdoor unit capacity (kW)											
	RAS-20FSN2		RAS-22FSN2		RAS-24FSN2		RAS-26FSN2		RAS-28FSN2		RAS-30FSN2	
	Cooling	Heating	Cooling	Heating	Cooling	Heating	Cooling	Heating	Cooling	Heating	Cooling	Heating
20.0	56.00	63.00	57.27	64.55	57.50	64.60	56.15	63.48	57.14	64.29	56.67	63.33
20.1	56.05	63.03	57.56	64.87	57.79	64.92	56.43	63.80	57.43	64.61	56.95	63.65
20.2	56.09	63.06	57.85	65.19	58.07	65.24	56.72	64.12	57.71	64.93	57.23	63.97
20.3	56.14	63.10	58.13	65.51	58.36	65.57	57.00	64.44	58.00	65.25	57.52	64.28
20.4	56.19	63.13	58.42	65.84	58.65	65.89	57.28	64.75	58.29	65.57	57.80	64.60
20.5	56.23	63.16	58.70	66.16	58.94	66.21	57.56	65.07	58.57	65.89	58.08	64.92
20.6	56.28	63.19	58.99	66.48	59.22	66.53	57.84	65.39	58.86	66.21	58.37	65.23
20.7	56.33	63.22	59.28	66.80	59.51	66.86	58.12	65.70	59.14	66.54	58.65	65.55
20.8	56.37	63.25	59.56	67.13	59.80	67.18	58.40	66.02	59.43	66.86	58.93	65.87
20.9	56.42	63.29	59.85	67.45	60.09	67.50	58.68	66.34	59.71	67.18	59.22	66.18
21.0	56.47	63.32	60.14	67.77	60.37	67.82	58.96	66.65	60.00	67.50	59.50	66.50
21.1	56.51	63.35	60.42	68.10	60.66	68.15	59.24	66.97	60.29	67.82	59.78	66.82
21.2	56.56	63.38	60.71	68.42	60.95	68.47	59.52	67.29	60.57	68.14	60.07	67.13
21.3	56.61	63.41	61.00	68.74	61.24	68.79	59.80	67.60	60.86	68.46	60.35	67.45
21.4	56.65	63.44	61.28	69.06	61.52	69.11	60.08	67.92	61.14	68.79	60.63	67.77
21.5	56.70	63.48	61.57	69.39	61.81	69.44	60.37	68.24	61.43	69.11	60.92	68.08
21.6	56.75	63.51	61.85	69.71	62.10	69.76	60.65	68.56	61.71	69.43	61.20	68.40
21.7	56.79	63.54	62.14	70.03	62.39	70.08	60.93	68.87	62.00	69.75	61.48	68.72
21.8	56.84	63.57	62.43	70.35	62.68	70.40	61.21	69.19	62.29	70.07	61.77	69.03
21.9	56.89	63.60	62.71	70.68	62.96	70.73	61.49	69.51	62.57	70.39	62.05	69.35
22.0	56.93	63.63	63.00	71.00	63.25	71.05	61.77	69.82	62.86	70.71	62.33	69.67
22.1	56.98	63.67	63.03	71.03	63.54	71.37	62.05	70.14	63.14	71.04	62.62	69.98
22.2	57.03	63.70	63.06	71.06	63.83	71.70	62.33	70.46	63.43	71.36	62.90	70.30
22.3	57.07	63.73	63.09	71.10	64.11	72.02	62.61	70.77	63.71	71.68	63.18	70.62
22.4	57.12	63.76	63.12	71.13	64.40	72.34	62.89	71.09	64.00	72.00	63.47	70.93
22.5	57.17	63.79	63.14	71.16	64.69	72.66	63.17	71.41	64.29	72.32	63.75	71.25
22.6	57.21	63.82	63.17	71.19	64.98	72.99	63.45	71.72	64.57	72.64	64.03	71.57
22.7	57.26	63.86	63.20	71.22	65.26	73.31	63.73	72.04	64.86	72.96	64.32	71.88
22.8	57.31	63.89	63.23	71.25	65.55	73.63	64.02	72.36	65.14	73.29	64.60	72.20
22.9	57.35	63.92	63.26	71.29	65.84	73.95	64.30	72.68	65.43	73.61	64.88	72.52
23.0	57.40	63.95	63.29	71.32	66.13	74.28	64.58	72.99	65.71	73.93	65.17	72.83
23.1	57.45	63.98	63.32	71.35	66.41	74.60	64.86	73.31	66.00	74.25	65.45	73.15
23.2	57.49	64.01	63.35	71.38	66.70	74.92	65.14	73.63	66.29	74.57	65.73	73.47
23.3	57.54	64.05	63.37	71.41	66.99	75.24	65.42	73.94	66.57	74.89	66.02	73.78
23.4	57.59	64.08	63.40	71.45	67.28	75.57	65.70	74.26	66.86	75.21	66.30	74.10
23.5	57.63	64.11	63.43	71.48	67.56	75.89	65.98	74.58	67.14	75.54	66.58	74.42
23.6	57.68	64.14	63.46	71.51	67.85	76.21	66.26	74.89	67.43	75.86	66.87	74.73
23.7	57.73	64.17	63.49	71.54	68.14	76.53	66.54	75.21	67.71	76.18	67.15	75.05
23.8	57.77	64.20	63.52	71.57	68.43	76.86	66.82	75.53	68.00	76.50	67.43	75.37
23.9	57.82	64.24	63.55	71.60	68.71	77.18	67.10	75.84	68.29	76.82	67.72	75.68
24.0	57.87	64.27	63.58	71.64	69.00	77.50	67.38	76.16	68.57	77.14	68.00	76.00
24.1	57.91	64.30	63.60	71.67	69.03	77.50	67.67	76.48	68.86	77.46	68.28	76.32
24.2	57.96	64.33	63.63	71.70	69.06	77.50	67.95	76.80	69.14	77.79	68.57	76.63
24.3	58.01	64.36	63.66	71.73	69.09	77.50	68.23	77.11	69.43	78.11	68.85	76.95
24.4	58.05	64.39	63.69	71.76	69.12	77.50	68.51	77.43	69.71	78.43	69.13	77.27
24.5	58.10	64.43	63.72	71.80	69.15	77.50	68.79	77.75	70.00	78.75	69.42	77.58
24.6	58.15	64.46	63.75	71.83	69.18	77.50	69.07	78.06	70.29	79.07	69.70	77.90
24.7	58.19	64.49	63.78	71.86	69.20	77.50	69.35	78.38	70.57	79.39	69.98	78.22
24.8	58.24	64.52	63.81	71.89	69.23	77.50	69.63	78.70	70.86	79.71	70.27	78.53
24.9	58.29	64.55	63.83	71.92	69.26	77.50	69.91	79.01	71.14	80.04	70.55	78.85

Total	Outdoor unit capacity (kW)											
	RAS-20FSN2		RAS-22FSN2		RAS-24FSN2		RAS-26FSN2		RAS-28FSN2		RAS-30FSN2	
	Cooling	Heating	Cooling	Heating	Cooling	Heating	Cooling	Heating	Cooling	Heating	Cooling	Heating
25.0	58.33	64.58	63.86	71.95	69.29	77.50	70.19	79.33	71.43	80.36	70.83	79.17
25.1	58.38	64.62	63.89	71.99	69.32	77.50	70.47	79.65	71.71	80.68	71.12	79.48
25.2	58.43	64.65	63.92	72.02	69.35	77.50	70.75	79.96	72.00	81.00	71.40	79.80
25.3	58.47	64.68	63.95	72.05	69.38	77.50	71.03	80.28	72.29	81.32	71.68	80.12
25.4	58.52	64.71	63.98	72.08	69.41	77.50	71.32	80.60	72.57	81.64	71.97	80.43
25.5	58.57	64.74	64.01	72.11	69.44	77.50	71.60	80.92	72.86	81.96	72.25	80.75
25.6	58.61	64.77	64.04	72.15	69.47	77.50	71.88	81.23	73.14	82.29	72.53	81.07
25.7	58.66	64.81	64.07	72.18	69.50	77.50	72.16	81.55	73.43	82.61	72.82	81.38
25.8	58.71	64.84	64.09	72.21	69.53	77.50	72.44	81.87	73.71	82.93	73.10	81.70
25.9	58.75	64.87	64.12	72.24	69.55	77.50	72.72	82.18	74.00	83.25	73.38	82.02
26.0	58.80	64.90	64.15	72.27	69.58	77.50	73.00	82.50	74.29	83.57	73.67	82.33
26.1			64.18	72.30	69.61	77.50	73.05	82.53	74.57	83.89	73.95	82.65
26.2			64.21	72.34	69.64	77.50	73.09	82.56	74.86	84.21	74.23	82.97
26.3			64.24	72.37	69.67	77.50	73.14	82.60	75.14	84.54	74.52	83.28
26.4			64.27	72.40	69.70	77.50	73.19	82.63	75.43	84.86	74.80	83.60
26.5			64.30	72.43	69.73	77.50	73.24	82.66	75.71	85.18	75.08	83.92
26.6			64.32	72.46	69.76	77.50	73.28	82.69	76.00	85.50	75.37	84.23
26.7			64.35	72.50	69.79	77.50	73.33	82.72	76.29	85.82	75.65	84.55
26.8			64.38	72.53	69.82	77.50	73.38	82.76	76.57	86.14	75.93	84.87
26.9			64.41	72.56	69.85	77.50	73.43	82.79	76.86	86.46	76.22	85.18
27.0			64.44	72.59	69.88	77.50	73.47	82.82	77.14	86.79	76.50	85.50
27.1			64.47	72.62	69.90	77.50	73.52	82.85	77.43	87.11	76.78	85.82
27.2			64.50	72.65	69.93	77.50	73.57	82.88	77.71	87.43	77.07	86.13
27.3			64.53	72.69	69.96	77.50	73.62	82.92	78.00	87.75	77.35	86.45
27.4			64.55	72.72	69.99	77.50	73.66	82.95	78.29	88.07	77.63	86.77
27.5			64.58	72.75	70.02	77.50	73.71	82.98	78.57	88.39	77.92	87.08
27.6			64.61	72.78	70.05	77.50	73.76	83.01	78.86	88.71	78.20	87.40
27.7			64.64	72.81	70.08	77.50	73.81	83.04	79.14	89.04	78.48	87.72
27.8			64.67	72.85	70.11	77.50	73.85	83.08	79.43	89.36	78.77	88.03
27.9			64.70	72.88	70.14	77.50	73.90	83.11	79.71	89.68	79.05	88.35
28.0			64.73	72.91	70.17	77.50	73.95	83.14	80.00	90.00	79.33	88.67
28.1			64.76	72.94	70.20	77.50	74.00	83.17	80.05	90.00	79.62	88.98
28.2			64.78	72.97	70.23	77.50	74.04	83.21	80.10	90.00	79.90	89.30
28.3			64.81	73.00	70.25	77.50	74.09	83.24	80.14	90.00	80.18	89.62
28.4			64.84	73.04	70.28	77.50	74.14	83.27	80.19	90.00	80.47	89.93
28.5			64.87	73.07	70.31	77.50	74.19	83.30	80.24	90.00	80.75	90.25
28.6			64.90	73.10	70.34	77.50	74.23	83.33	80.29	90.00	81.03	90.57
28.7					70.37	77.50	74.28	83.37	80.33	90.00	81.32	90.88
28.8					70.40	77.50	74.33	83.40	80.38	90.00	81.60	91.20
28.9					70.43	77.50	74.38	83.43	80.43	90.00	81.88	91.52
29.0					70.46	77.50	74.42	83.46	80.48	90.00	82.17	91.83
29.1					70.49	77.50	74.47	83.49	80.52	90.00	82.45	92.15
29.2					70.52	77.50	74.52	83.53	80.57	90.00	82.73	92.47
29.3					70.55	77.50	74.57	83.56	80.62	90.00	83.02	92.78
29.4					70.58	77.50	74.61	83.59	80.67	90.00	83.30	93.10
29.5					70.60	77.50	74.66	83.62	80.71	90.00	83.58	93.42
29.6					70.63	77.50	74.71	83.65	80.76	90.00	83.87	93.73
29.7					70.66	77.50	74.76	83.69	80.81	90.00	84.15	94.05
29.8					70.69	77.50	74.80	83.72	80.86	90.00	84.43	94.37
29.9					70.72	77.50	74.85	83.75	80.90	90.00	84.72	94.68

Total	Outdoor unit capacity (kW)													
	RAS-20FSN2		RAS-22FSN2		RAS-24FSN2		RAS-26FSN2		RAS-28FSN2		RAS-30FSN2			
	Cooling	Heating	Cooling	Heating	Cooling	Heating	Cooling	Heating	Cooling	Heating	Cooling	Heating		
30.0					70.75	77.50	74.90	83.78	80.95	90.00	85.00	95.00		
30.1					70.78	77.50	74.94	83.81	81.00	90.00	85.05	95.03		
30.2					70.81	77.50	74.99	83.85	81.05	90.00	85.10	95.06		
30.3					70.84	77.50	75.04	83.88	81.10	90.00	85.14	95.10		
30.4					70.87	77.50	75.09	83.91	81.14	90.00	85.19	95.13		
30.5					70.90	77.50	75.13	83.94	81.19	90.00	85.24	95.16		
30.6					70.93	77.50	75.18	83.97	81.24	90.00	85.29	95.19		
30.7					70.95	77.50	75.23	84.01	81.29	90.00	85.33	95.23		
30.8					70.98	77.50	75.28	84.04	81.33	90.00	85.38	95.26		
30.9					71.01	77.50	75.32	84.07	81.38	90.00	85.43	95.29		
31.0					71.04	77.50	75.37	84.10	81.43	90.00	85.48	95.32		
31.1					71.07	77.50	75.42	84.13	81.48	90.00	85.53	95.35		
31.2					71.10	77.50	75.47	84.17	81.52	90.00	85.57	95.39		
31.3									75.51	84.20	81.57	90.00	85.62	95.42
31.4									75.56	84.23	81.62	90.00	85.67	95.45
31.5									75.61	84.26	81.67	90.00	85.72	95.48
31.6									75.66	84.29	81.71	90.00	85.76	95.52
31.7									75.70	84.33	81.76	90.00	85.81	95.55
31.8									75.75	84.36	81.81	90.00	85.86	95.58
31.9									75.80	84.39	81.86	90.00	85.91	95.61
32.0									75.85	84.42	81.90	90.00	85.96	95.64
32.1									75.89	84.46	81.95	90.00	86.00	95.68
32.2									75.94	84.49	82.00	90.00	86.05	95.71
32.3									75.99	84.52	82.05	90.00	86.10	95.74
32.4									76.04	84.55	82.10	90.00	86.15	95.77
32.5									76.08	84.58	82.14	90.00	86.19	95.81
32.6									76.13	84.62	82.19	90.00	86.24	95.84
32.7									76.18	84.65	82.24	90.00	86.29	95.87
32.8									76.23	84.68	82.29	90.00	86.34	95.90
32.9									76.27	84.71	82.33	90.00	86.39	95.93
33.0									76.32	84.74	82.38	90.00	86.43	95.97
33.1									76.37	84.78	82.43	90.00	86.48	96.00
33.2									76.42	84.81	82.48	90.00	86.53	96.03
33.3									76.46	84.84	82.52	90.00	86.58	96.06
33.4									76.51	84.87	82.57	90.00	86.62	96.10
33.5									76.56	84.90	82.62	90.00	86.67	96.13
33.6									76.61	84.94	82.67	90.00	86.72	96.16
33.7									76.65	84.97	82.71	90.00	86.77	96.19
33.8									76.70	85.00	82.76	90.00	86.82	96.22
33.9											82.81	90.00	86.86	96.26
34.0											82.86	90.00	86.91	96.29
34.1											82.90	90.00	86.96	96.32
34.2											82.95	90.00	87.01	96.35
34.3											83.00	90.00	87.05	96.39
34.4											83.05	90.00	87.10	96.42
34.5											83.10	90.00	87.15	96.45
34.6											83.14	90.00	87.20	96.48
34.7											83.19	90.00	87.25	96.51
34.8											83.24	90.00	87.29	96.55
34.9											83.29	90.00	87.34	96.58

Total	Outdoor unit capacity (kW)											
	RAS-20FSN2		RAS-22FSN2		RAS-24FSN2		RAS-26FSN2		RAS-28FSN2		RAS-30FSN2	
	Cooling	Heating	Cooling	Heating	Cooling	Heating	Cooling	Heating	Cooling	Heating	Cooling	Heating
35.0									83.33	90.00	87.39	96.61
35.1									83.38	90.00	87.44	96.64
35.2									83.43	90.00	87.48	96.68
35.3									83.48	90.00	87.53	96.71
35.4									83.52	90.00	87.58	96.74
35.5									83.57	90.00	87.63	96.77
35.6									83.62	90.00	87.68	96.80
35.7									83.67	90.00	87.72	96.84
35.8									83.71	90.00	87.77	96.87
35.9									83.76	90.00	87.82	96.90
36.0									83.81	90.00	87.87	96.93
36.1									83.86	90.00	87.91	96.97
36.2									83.90	90.00	87.96	97.00
36.3									83.95	90.00	88.01	97.03
36.4									84.00	90.00	88.06	97.06
36.5											88.11	97.09
36.6											88.15	97.13
36.7											88.20	97.16
36.8											88.25	97.19
36.9											88.30	97.22
37.0	-		-		-		-				88.34	97.26
37.1											88.39	97.29
37.2											88.44	97.32
37.3											88.49	97.35
37.4											88.54	97.38
37.5											88.58	97.42
37.6											88.63	97.45
37.7											88.68	97.48
37.8											88.73	97.51
37.9											88.77	97.55
38.0											88.82	97.58
38.1											88.87	97.61
38.2											88.92	97.64
38.3											88.97	97.67
38.4											89.01	97.71
38.5											89.06	97.74
38.6											89.11	97.77
38.7											89.16	97.80
38.8											89.20	97.84
38.9											89.25	97.87
39.0											89.30	97.90

4

◆ RAS-32~42FSN2

Total (HP)	Outdoor unit capacity (kW)											
	RAS-32FSN2		RAS-34FSN2		RAS-36FSN2		RAS-38FSN2		RAS-40FSN2		RAS-42FSN2	
	Cooling	Heating	Cooling	Heating	Cooling	Heating	Cooling	Heating	Cooling	Heating	Cooling	Heating
16.0	45.00	50.00										
16.1	45.28	50.31										
16.2	45.56	50.63										
16.3	45.84	50.94										
16.4	46.13	51.25										
16.5	46.41	51.56										
16.6	46.69	51.88										
16.7	46.97	52.19										
16.8	47.25	52.50										
16.9	47.53	52.81										
17.0	47.81	53.12	48.00	54.00								
17.1	48.09	53.44	48.28	54.32								
17.2	48.37	53.75	48.56	54.64								
17.3	48.66	54.06	48.85	54.95								
17.4	48.94	54.37	49.13	55.27								
17.5	49.22	54.69	49.41	55.59								
17.6	49.50	55.00	49.69	55.91								
17.7	49.78	55.31	49.98	56.22								
17.8	50.06	55.62	50.26	56.54								
17.9	50.34	55.94	50.54	56.86								
18.0	50.62	56.25	50.82	57.18	50.50	56.50						
18.1	50.91	56.56	51.11	57.49	50.78	56.81						
18.2	51.19	56.87	51.39	57.81	51.06	57.13						
18.3	51.47	57.19	51.67	58.13	51.34	57.44						
18.4	51.75	57.50	51.95	58.45	51.62	57.76						
18.5	52.03	57.81	52.24	58.76	51.90	58.07						
18.6	52.31	58.12	52.52	59.08	52.18	58.38						
18.7	52.59	58.44	52.80	59.40	52.46	58.70						
18.8	52.87	58.75	53.08	59.72	52.74	59.01						
18.9	53.16	59.06	53.36	60.04	53.03	59.33						
19.0	53.44	59.37	53.65	60.35	53.31	59.64	53.50	59.80				
19.1	53.72	59.69	53.93	60.67	53.59	59.95	53.78	60.11				
19.2	54.00	60.00	54.21	60.99	53.87	60.27	54.06	60.43				
19.3	54.28	60.31	54.49	61.31	54.15	60.58	54.34	60.74				
19.4	54.56	60.62	54.78	61.62	54.43	60.89	54.63	61.06				
19.5	54.84	60.94	55.06	61.94	54.71	61.21	54.91	61.37				
19.6	55.12	61.25	55.34	62.26	54.99	61.52	55.19	61.69				
19.7	55.41	61.56	55.62	62.58	55.27	61.84	55.47	62.00				
19.8	55.69	61.87	55.91	62.89	55.55	62.15	55.75	62.31				
19.9	55.97	62.19	56.19	63.21	55.83	62.46	56.03	62.63				
20.0	56.25	62.50	56.47	63.53	56.11	62.78	56.32	62.94	56.50	63.50		
20.1	56.53	62.81	56.75	63.85	56.39	63.09	56.60	63.26	56.78	63.82		
20.2	56.81	63.12	57.04	64.16	56.67	63.41	56.88	63.57	57.07	64.14		
20.3	57.09	63.44	57.32	64.48	56.95	63.72	57.16	63.88	57.35	64.45		
20.4	57.37	63.75	57.60	64.80	57.23	64.03	57.44	64.20	57.63	64.77		
20.5	57.66	64.06	57.88	65.12	57.51	64.35	57.72	64.51	57.91	65.09		
20.6	57.94	64.37	58.16	65.44	57.79	64.66	58.01	64.83	58.20	65.41		
20.7	58.22	64.69	58.45	65.75	58.08	64.98	58.29	65.14	58.48	65.72		
20.8	58.50	65.00	58.73	66.07	58.36	65.29	58.57	65.46	58.76	66.04		
20.9	58.78	65.31	59.01	66.39	58.64	65.60	58.85	65.77	59.04	66.36		

Total (HP)	Outdoor unit capacity (kW)											
	RAS-32FSN2		RAS-34FSN2		RAS-36FSN2		RAS-38FSN2		RAS-40FSN2		RAS-42FSN2	
	Cooling	Heating	Cooling	Heating	Cooling	Heating	Cooling	Heating	Cooling	Heating	Cooling	Heating
21.0	59.06	65.62	59.29	66.71	58.92	65.92	59.13	66.08	59.33	66.68	59.00	66.00
21.1	59.34	65.94	59.58	67.02	59.20	66.23	59.41	66.40	59.61	66.99	59.28	66.31
21.2	59.62	66.25	59.86	67.34	59.48	66.54	59.69	66.71	59.89	67.31	59.56	66.63
21.3	59.91	66.56	60.14	67.66	59.76	66.86	59.98	67.03	60.17	67.63	59.84	66.94
21.4	60.19	66.87	60.42	67.98	60.04	67.17	60.26	67.34	60.46	67.95	60.12	67.26
21.5	60.47	67.19	60.71	68.29	60.32	67.49	60.54	67.66	60.74	68.26	60.40	67.57
21.6	60.75	67.50	60.99	68.61	60.60	67.80	60.82	67.97	61.02	68.58	60.69	67.89
21.7	61.03	67.81	61.27	68.93	60.88	68.11	61.10	68.28	61.30	68.90	60.97	68.20
21.8	61.31	68.12	61.55	69.25	61.16	68.43	61.38	68.60	61.59	69.22	61.25	68.51
21.9	61.59	68.44	61.84	69.56	61.44	68.74	61.67	68.91	61.87	69.53	61.53	68.83
22.0	61.87	68.75	62.12	69.88	61.72	69.06	61.95	69.23	62.15	69.85	61.81	69.14
22.1	62.16	69.06	62.40	70.20	62.00	69.37	62.23	69.54	62.43	70.17	62.09	69.46
22.2	62.44	69.37	62.68	70.52	62.28	69.68	62.51	69.85	62.72	70.49	62.37	69.77
22.3	62.72	69.69	62.96	70.84	62.56	70.00	62.79	70.17	63.00	70.80	62.65	70.09
22.4	63.00	70.00	63.25	71.15	62.84	70.31	63.07	70.48	63.28	71.12	62.93	70.40
22.5	63.28	70.31	63.53	71.47	63.13	70.63	63.36	70.80	63.56	71.44	63.21	70.71
22.6	63.56	70.62	63.81	71.79	63.41	70.94	63.64	71.11	63.85	71.76	63.50	71.03
22.7	63.84	70.94	64.09	72.11	63.69	71.25	63.92	71.43	64.13	72.07	63.78	71.34
22.8	64.12	71.25	64.38	72.42	63.97	71.57	64.20	71.74	64.41	72.39	64.06	71.66
22.9	64.41	71.56	64.66	72.74	64.25	71.88	64.48	72.05	64.69	72.71	64.34	71.97
23.0	64.69	71.87	64.94	73.06	64.53	72.19	64.76	72.37	64.98	73.03	64.62	72.29
23.1	64.97	72.19	65.22	73.38	64.81	72.51	65.04	72.68	65.26	73.34	64.90	72.60
23.2	65.25	72.50	65.51	73.69	65.09	72.82	65.33	73.00	65.54	73.66	65.18	72.91
23.3	65.53	72.81	65.79	74.01	65.37	73.14	65.61	73.31	65.82	73.98	65.46	73.23
23.4	65.81	73.12	66.07	74.33	65.65	73.45	65.89	73.63	66.11	74.30	65.74	73.54
23.5	66.09	73.44	66.35	74.65	65.93	73.76	66.17	73.94	66.39	74.61	66.02	73.86
23.6	66.37	73.75	66.64	74.96	66.21	74.08	66.45	74.25	66.67	74.93	66.30	74.17
23.7	66.66	74.06	66.92	75.28	66.49	74.39	66.73	74.57	66.95	75.25	66.59	74.49
23.8	66.94	74.37	67.20	75.60	66.77	74.71	67.02	74.88	67.24	75.57	66.87	74.80
23.9	67.22	74.69	67.48	75.92	67.05	75.02	67.30	75.20	67.52	75.88	67.15	75.11
24.0	67.50	75.00	67.76	76.24	67.33	75.33	67.58	75.51	67.80	76.20	67.43	75.43
24.1	67.78	75.31	68.05	76.55	67.61	75.65	67.86	75.82	68.08	76.52	67.71	75.74
24.2	68.06	75.62	68.33	76.87	67.89	75.96	68.14	76.14	68.37	76.84	67.99	76.06
24.3	68.34	75.94	68.61	77.19	68.18	76.28	68.42	76.45	68.65	77.15	68.27	76.37
24.4	68.62	76.25	68.89	77.51	68.46	76.59	68.71	76.77	68.93	77.47	68.55	76.69
24.5	68.91	76.56	69.18	77.82	68.74	76.90	68.99	77.08	69.21	77.79	68.83	77.00
24.6	69.19	76.87	69.46	78.14	69.02	77.22	69.27	77.40	69.50	78.11	69.11	77.31
24.7	69.47	77.19	69.74	78.46	69.30	77.53	69.55	77.71	69.78	78.42	69.40	77.63
24.8	69.75	77.50	70.02	78.78	69.58	77.84	69.83	78.02	70.06	78.74	69.68	77.94
24.9	70.03	77.81	70.31	79.09	69.86	78.16	70.11	78.34	70.34	79.06	69.96	78.26
25.0	70.31	78.12	70.59	79.41	70.14	78.47	70.39	78.65	70.63	79.38	70.24	78.57
25.1	70.59	78.44	70.87	79.73	70.42	78.79	70.68	78.97	70.91	79.69	70.52	78.89
25.2	70.87	78.75	71.15	80.05	70.70	79.10	70.96	79.28	71.19	80.01	70.80	79.20
25.3	71.16	79.06	71.44	80.36	70.98	79.41	71.24	79.60	71.47	80.33	71.08	79.51
25.4	71.44	79.37	71.72	80.68	71.26	79.73	71.52	79.91	71.76	80.65	71.36	79.83
25.5	71.72	79.69	72.00	81.00	71.54	80.04	71.80	80.22	72.04	80.96	71.64	80.14
25.6	72.00	80.00	72.28	81.32	71.82	80.36	72.08	80.54	72.32	81.28	71.92	80.46
25.7	72.28	80.31	72.56	81.64	72.10	80.67	72.37	80.85	72.60	81.60	72.20	80.77
25.8	72.56	80.62	72.85	81.95	72.38	80.98	72.65	81.17	72.89	81.92	72.49	81.09
25.9	72.84	80.94	73.13	82.27	72.66	81.30	72.93	81.48	73.17	82.23	72.77	81.40

Total (HP)	Outdoor unit capacity (kW)											
	RAS-32FSN2		RAS-34FSN2		RAS-36FSN2		RAS-38FSN2		RAS-40FSN2		RAS-42FSN2	
	Cooling	Heating	Cooling	Heating	Cooling	Heating	Cooling	Heating	Cooling	Heating	Cooling	Heating
26.0	73.12	81.25	73.41	82.59	72.94	81.61	73.21	81.79	73.45	82.55	73.05	81.71
26.1	73.41	81.56	73.69	82.91	73.23	81.93	73.49	82.11	73.73	82.87	73.33	82.03
26.2	73.69	81.87	73.98	83.22	73.51	82.24	73.77	82.42	74.02	83.19	73.61	82.34
26.3	73.97	82.19	74.26	83.54	73.79	82.55	74.06	82.74	74.30	83.50	73.89	82.66
26.4	74.25	82.50	74.54	83.86	74.07	82.87	74.34	83.05	74.58	83.82	74.17	82.97
26.5	74.53	82.81	74.82	84.18	74.35	83.18	74.62	83.37	74.86	84.14	74.45	83.29
26.6	74.81	83.12	75.11	84.49	74.63	83.49	74.90	83.68	75.15	84.46	74.73	83.60
26.7	75.09	83.44	75.39	84.81	74.91	83.81	75.18	83.99	75.43	84.77	75.01	83.91
26.8	75.37	83.75	75.67	85.13	75.19	84.12	75.46	84.31	75.71	85.09	75.30	84.23
26.9	75.66	84.06	75.95	85.45	75.47	84.44	75.74	84.62	75.99	85.41	75.58	84.54
27.0	75.94	84.37	76.24	85.76	75.75	84.75	76.03	84.94	76.28	85.73	75.86	84.86
27.1	76.22	84.69	76.52	86.08	76.03	85.06	76.31	85.25	76.56	86.04	76.14	85.17
27.2	76.50	85.00	76.80	86.40	76.31	85.38	76.59	85.57	76.84	86.36	76.42	85.49
27.3	76.78	85.31	77.08	86.72	76.59	85.69	76.87	85.88	77.12	86.68	76.70	85.80
27.4	77.06	85.62	77.36	87.04	76.87	86.01	77.15	86.19	77.41	87.00	76.98	86.11
27.5	77.34	85.94	77.65	87.35	77.15	86.32	77.43	86.51	77.69	87.31	77.26	86.43
27.6	77.62	86.25	77.93	87.67	77.43	86.63	77.72	86.82	77.97	87.63	77.54	86.74
27.7	77.91	86.56	78.21	87.99	77.71	86.95	78.00	87.14	78.25	87.95	77.82	87.06
27.8	78.19	86.87	78.49	88.31	77.99	87.26	78.28	87.45	78.54	88.27	78.10	87.37
27.9	78.47	87.19	78.78	88.62	78.28	87.58	78.56	87.76	78.82	88.58	78.39	87.69
28.0	78.75	87.50	79.06	88.94	78.56	87.89	78.84	88.08	79.10	88.90	78.67	88.00
28.1	79.03	87.81	79.34	89.26	78.84	88.20	79.12	88.39	79.38	89.22	78.95	88.31
28.2	79.31	88.12	79.62	89.58	79.12	88.52	79.41	88.71	79.67	89.54	79.23	88.63
28.3	79.59	88.44	79.91	89.89	79.40	88.83	79.69	89.02	79.95	89.85	79.51	88.94
28.4	79.87	88.75	80.19	90.21	79.68	89.14	79.97	89.34	80.23	90.17	79.79	89.26
28.5	80.16	89.06	80.47	90.53	79.96	89.46	80.25	89.65	80.51	90.49	80.07	89.57
28.6	80.44	89.37	80.75	90.85	80.24	89.77	80.53	89.96	80.80	90.81	80.35	89.89
28.7	80.72	89.69	81.04	91.16	80.52	90.09	80.81	90.28	81.08	91.12	80.63	90.20
28.8	81.00	90.00	81.32	91.48	80.80	90.40	81.09	90.59	81.36	91.44	80.91	90.51
28.9	81.28	90.31	81.60	91.80	81.08	90.71	81.38	90.91	81.64	91.76	81.20	90.83
29.0	81.56	90.62	81.88	92.12	81.36	91.03	81.66	91.22	81.93	92.08	81.48	91.14
29.1	81.84	90.94	82.16	92.44	81.64	91.34	81.94	91.54	82.21	92.39	81.76	91.46
29.2	82.12	91.25	82.45	92.75	81.92	91.66	82.22	91.85	82.49	92.71	82.04	91.77
29.3	82.41	91.56	82.73	93.07	82.20	91.97	82.50	92.16	82.77	93.03	82.32	92.09
29.4	82.69	91.87	83.01	93.39	82.48	92.28	82.78	92.48	83.06	93.35	82.60	92.40
29.5	82.97	92.19	83.29	93.71	82.76	92.60	83.07	92.79	83.34	93.66	82.88	92.71
29.6	83.25	92.50	83.58	94.02	83.04	92.91	83.35	93.11	83.62	93.98	83.16	93.03
29.7	83.53	92.81	83.86	94.34	83.33	93.23	83.63	93.42	83.90	94.30	83.44	93.34
29.8	83.81	93.13	84.14	94.66	83.61	93.54	83.91	93.73	84.19	94.62	83.72	93.66
29.9	84.09	93.44	84.42	94.98	83.89	93.85	84.19	94.05	84.47	94.93	84.00	93.97
30.0	84.38	93.75	84.71	95.29	84.17	94.17	84.47	94.36	84.75	95.25	84.29	94.29
30.1	84.66	94.06	84.99	95.61	84.45	94.48	84.76	94.68	85.03	95.57	84.57	94.60
30.2	84.94	94.38	85.27	95.93	84.73	94.79	85.04	94.99	85.32	95.89	84.85	94.91
30.3	85.22	94.69	85.55	96.25	85.01	95.11	85.32	95.31	85.60	96.20	85.13	95.23
30.4	85.50	95.00	85.84	96.56	85.29	95.42	85.60	95.62	85.88	96.52	85.41	95.54
30.5	85.78	95.31	86.12	96.88	85.57	95.74	85.88	95.93	86.16	96.84	85.69	95.86
30.6	86.06	95.63	86.40	97.20	85.85	96.05	86.16	96.25	86.45	97.16	85.97	96.17
30.7	86.34	95.94	86.68	97.52	86.13	96.36	86.44	96.56	86.73	97.47	86.25	96.49
30.8	86.63	96.25	86.96	97.84	86.41	96.68	86.73	96.88	87.01	97.79	86.53	96.80
30.9	86.91	96.56	87.25	98.15	86.69	96.99	87.01	97.19	87.29	98.11	86.81	97.11

Total (HP)	Outdoor unit capacity (kW)											
	RAS-32FSN2		RAS-34FSN2		RAS-36FSN2		RAS-38FSN2		RAS-40FSN2		RAS-42FSN2	
	Cooling	Heating	Cooling	Heating	Cooling	Heating	Cooling	Heating	Cooling	Heating	Cooling	Heating
31.0	87.19	96.88	87.53	98.47	86.97	97.31	87.29	97.51	87.58	98.43	87.10	97.43
31.1	87.47	97.19	87.81	98.79	87.25	97.62	87.57	97.82	87.86	98.74	87.38	97.74
31.2	87.75	97.50	88.09	99.11	87.53	97.93	87.85	98.13	88.14	99.06	87.66	98.06
31.3	88.03	97.81	88.38	99.42	87.81	98.25	88.13	98.45	88.42	99.38	87.94	98.37
31.4	88.31	98.13	88.66	99.74	88.09	98.56	88.42	98.76	88.71	99.70	88.22	98.69
31.5	88.59	98.44	88.94	100.06	88.38	98.88	88.70	99.08	88.99	100.01	88.50	99.00
31.6	88.88	98.75	89.22	100.38	88.66	99.19	88.98	99.39	89.27	100.33	88.78	99.31
31.7	89.16	99.06	89.51	100.69	88.94	99.50	89.26	99.70	89.55	100.65	89.06	99.63
31.8	89.44	99.38	89.79	101.01	89.22	99.82	89.54	100.02	89.84	100.97	89.34	99.94
31.9	89.72	99.69	90.07	101.33	89.50	100.13	89.82	100.33	90.12	101.28	89.62	100.26
32.0	90.00	100.00	90.35	101.65	89.78	100.44	90.11	100.65	90.40	101.60	89.90	100.57
32.1	90.05	100.03	90.64	101.96	90.06	100.76	90.39	100.96	90.68	101.92	90.19	100.89
32.2	90.09	100.06	90.92	102.28	90.34	101.07	90.67	101.28	90.97	102.24	90.47	101.20
32.3	90.14	100.09	91.20	102.60	90.62	101.39	90.95	101.59	91.25	102.55	90.75	101.51
32.4	90.19	100.13	91.48	102.92	90.90	101.70	91.23	101.90	91.53	102.87	91.03	101.83
32.5	90.23	100.16	91.76	103.24	91.18	102.01	91.51	102.22	91.81	103.19	91.31	102.14
32.6	90.28	100.19	92.05	103.55	91.46	102.33	91.79	102.53	92.10	103.51	91.59	102.46
32.7	90.33	100.22	92.33	103.87	91.74	102.64	92.08	102.85	92.38	103.82	91.87	102.77
32.8	90.38	100.25	92.61	104.19	92.02	102.96	92.36	103.16	92.66	104.14	92.15	103.09
32.9	90.42	100.28	92.89	104.51	92.30	103.27	92.64	103.48	92.94	104.46	92.43	103.40
33.0	90.47	100.31	93.18	104.82	92.58	103.58	92.92	103.79	93.23	104.78	92.71	103.71
33.1	90.52	100.34	93.46	105.14	92.86	103.90	93.20	104.10	93.51	105.09	93.00	104.03
33.2	90.56	100.38	93.74	105.46	93.14	104.21	93.48	104.42	93.79	105.41	93.28	104.34
33.3	90.61	100.41	94.02	105.78	93.43	104.53	93.77	104.73	94.07	105.73	93.56	104.66
33.4	90.66	100.44	94.31	106.09	93.71	104.84	94.05	105.05	94.36	106.05	93.84	104.97
33.5	90.70	100.47	94.59	106.41	93.99	105.15	94.33	105.36	94.64	106.36	94.12	105.29
33.6	90.75	100.50	94.87	106.73	94.27	105.47	94.61	105.67	94.92	106.68	94.40	105.60
33.7	90.80	100.53	95.15	107.05	94.55	105.78	94.89	105.99	95.20	107.00	94.68	105.91
33.8	90.84	100.56	95.44	107.36	94.83	106.09	95.17	106.30	95.49	107.32	94.96	106.23
33.9	90.89	100.59	95.72	107.68	95.11	106.41	95.46	106.62	95.77	107.63	95.24	106.54
34.0	90.94	100.63	96.00	108.00	95.39	106.72	95.74	106.93	96.05	107.95	95.52	106.86
34.1	90.98	100.66	96.05	108.00	95.67	107.04	96.02	107.25	96.33	108.27	95.80	107.17
34.2	91.03	100.69	96.09	108.00	95.95	107.35	96.30	107.56	96.62	108.59	96.09	107.49
34.3	91.08	100.72	96.14	108.00	96.23	107.66	96.58	107.87	96.90	108.90	96.37	107.80
34.4	91.13	100.75	96.19	108.00	96.51	107.98	96.86	108.19	97.18	109.22	96.65	108.11
34.5	91.17	100.78	96.24	108.00	96.79	108.29	97.14	108.50	97.46	109.54	96.93	108.43
34.6	91.22	100.81	96.28	108.00	97.07	108.61	97.43	108.82	97.75	109.86	97.21	108.74
34.7	91.27	100.84	96.33	108.00	97.35	108.92	97.71	109.13	98.03	110.17	97.49	109.06
34.8	91.31	100.88	96.38	108.00	97.63	109.23	97.99	109.45	98.31	110.49	97.77	109.37
34.9	91.36	100.91	96.42	108.00	97.91	109.55	98.27	109.76	98.59	110.81	98.05	109.69
35.0	91.41	100.94	96.47	108.00	98.19	109.86	98.55	110.07	98.88	111.13	98.33	110.00
35.1	91.45	100.97	96.52	108.00	98.48	110.18	98.83	110.39	99.16	111.44	98.61	110.31
35.2	91.50	101.00	96.56	108.00	98.76	110.49	99.12	110.70	99.44	111.76	98.90	110.63
35.3	91.55	101.03	96.61	108.00	99.04	110.80	99.40	111.02	99.72	112.08	99.18	110.94
35.4	91.59	101.06	96.66	108.00	99.32	111.12	99.68	111.33	100.01	112.40	99.46	111.26
35.5	91.64	101.09	96.71	108.00	99.60	111.43	99.96	111.64	100.29	112.71	99.74	111.57
35.6	91.69	101.13	96.75	108.00	99.88	111.74	100.24	111.96	100.57	113.03	100.02	111.89
35.7	91.73	101.16	96.80	108.00	100.16	112.06	100.52	112.27	100.85	113.35	100.30	112.20
35.8	91.78	101.19	96.85	108.00	100.44	112.37	100.81	112.59	101.14	113.67	100.58	112.51
35.9	91.83	101.22	96.89	108.00	100.72	112.69	101.09	112.90	101.42	113.98	100.86	112.83

Total (HP)	Outdoor unit capacity (kW)											
	RAS-32FSN2		RAS-34FSN2		RAS-36FSN2		RAS-38FSN2		RAS-40FSN2		RAS-42FSN2	
	Cooling	Heating	Cooling	Heating	Cooling	Heating	Cooling	Heating	Cooling	Heating	Cooling	Heating
36.0	91.88	101.25	96.94	108.00	101.00	113.00	101.37	113.22	101.70	114.30	101.14	113.14
36.1	91.92	101.28	96.99	108.00	101.05	113.00	101.65	113.53	101.98	114.62	101.42	113.46
36.2	91.97	101.31	97.04	108.00	101.09	113.00	101.93	113.84	102.27	114.94	101.70	113.77
36.3	92.02	101.34	97.08	108.00	101.14	113.00	102.21	114.16	102.55	115.25	101.99	114.09
36.4	92.06	101.38	97.13	108.00	101.19	113.00	102.49	114.47	102.83	115.57	102.27	114.40
36.5	92.11	101.41	97.18	108.00	101.24	113.00	102.78	114.79	103.11	115.89	102.55	114.71
36.6	92.16	101.44	97.22	108.00	101.28	113.00	103.06	115.10	103.40	116.21	102.83	115.03
36.7	92.20	101.47	97.27	108.00	101.33	113.00	103.34	115.42	103.68	116.52	103.11	115.34
36.8	92.25	101.50	97.32	108.00	101.38	113.00	103.62	115.73	103.96	116.84	103.39	115.66
36.9	92.30	101.53	97.36	108.00	101.43	113.00	103.90	116.04	104.24	117.16	103.67	115.97
37.0	92.34	101.56	97.41	108.00	101.47	113.00	104.18	116.36	104.53	117.48	103.95	116.29
37.1	92.39	101.59	97.46	108.00	101.52	113.00	104.47	116.67	104.81	117.79	104.23	116.60
37.2	92.44	101.63	97.51	108.00	101.57	113.00	104.75	116.99	105.09	118.11	104.51	116.91
37.3	92.48	101.66	97.55	108.00	101.61	113.00	105.03	117.30	105.37	118.43	104.80	117.23
37.4	92.53	101.69	97.60	108.00	101.66	113.00	105.31	117.61	105.66	118.75	105.08	117.54
37.5	92.58	101.72	97.65	108.00	101.71	113.00	105.59	117.93	105.94	119.06	105.36	117.86
37.6	92.63	101.75	97.69	108.00	101.76	113.00	105.87	118.24	106.22	119.38	105.64	118.17
37.7	92.67	101.78	97.74	108.00	101.80	113.00	106.16	118.56	106.50	119.70	105.92	118.49
37.8	92.72	101.81	97.79	108.00	101.85	113.00	106.44	118.87	106.79	120.02	106.20	118.80
37.9	92.77	101.84	97.84	108.00	101.90	113.00	106.72	119.19	107.07	120.33	106.48	119.11
38.0	92.81	101.88	97.88	108.00	101.94	113.00	107.00	119.50	107.35	120.65	106.76	119.43
38.1	92.86	101.91	97.93	108.00	101.99	113.00	107.05	119.50	107.63	120.97	107.04	119.74
38.2	92.91	101.94	97.98	108.00	102.04	113.00	107.09	119.50	107.92	121.29	107.32	120.06
38.3	92.95	101.97	98.02	108.00	102.09	113.00	107.14	119.50	108.20	121.60	107.60	120.37
38.4	93.00	102.00	98.07	108.00	102.13	113.00	107.19	119.50	108.48	121.92	107.89	120.69
38.5	93.05	102.03	98.12	108.00	102.18	113.00	107.24	119.50	108.76	122.24	108.17	121.00
38.6	93.09	102.06	98.16	108.00	102.23	113.00	107.28	119.50	109.05	122.56	108.45	121.31
38.7	93.14	102.09	98.21	108.00	102.28	113.00	107.33	119.50	109.33	122.87	108.73	121.63
38.8	93.19	102.13	98.26	108.00	102.32	113.00	107.38	119.50	109.61	123.19	109.01	121.94
38.9	93.23	102.16	98.31	108.00	102.37	113.00	107.43	119.50	109.89	123.51	109.29	122.26
39.0	93.28	102.19	98.35	108.00	102.42	113.00	107.47	119.50	110.18	123.83	109.57	122.57
39.1	93.33	102.22	98.40	108.00	102.46	113.00	107.52	119.50	110.46	124.14	109.85	122.89
39.2	93.38	102.25	98.45	108.00	102.51	113.00	107.57	119.50	110.74	124.46	110.13	123.20
39.3	93.42	102.28	98.49	108.00	102.56	113.00	107.62	119.50	111.02	124.78	110.41	123.51
39.4	93.47	102.31	98.54	108.00	102.61	113.00	107.66	119.50	111.31	125.10	110.70	123.83
39.5	93.52	102.34	98.59	108.00	102.65	113.00	107.71	119.50	111.59	125.41	110.98	124.14
39.6	93.56	102.38	98.64	108.00	102.70	113.00	107.76	119.50	111.87	125.73	111.26	124.46
39.7	93.61	102.41	98.68	108.00	102.75	113.00	107.81	119.50	112.15	126.05	111.54	124.77
39.8	93.66	102.44	98.73	108.00	102.79	113.00	107.85	119.50	112.44	126.37	111.82	125.09
39.9	93.70	102.47	98.78	108.00	102.84	113.00	107.90	119.50	112.72	126.68	112.10	125.40
40.0	93.75	102.50	98.82	108.00	102.89	113.00	107.95	119.50	113.00	127.00	112.38	125.71
40.1	93.80	102.53	98.87	108.00	102.94	113.00	107.99	119.50	113.03	127.00	112.66	126.03
40.2	93.84	102.56	98.92	108.00	102.98	113.00	108.04	119.50	113.06	127.00	112.94	126.34
40.3	93.89	102.59	98.96	108.00	103.03	113.00	108.09	119.50	113.09	127.00	113.22	126.66
40.4	93.94	102.63	99.01	108.00	103.08	113.00	108.14	119.50	113.11	127.00	113.50	126.97
40.5	93.98	102.66	99.06	108.00	103.13	113.00	108.18	119.50	113.14	127.00	113.79	127.29
40.6	94.03	102.69	99.11	108.00	103.17	113.00	108.23	119.50	113.17	127.00	114.07	127.60
40.7	94.08	102.72	99.15	108.00	103.22	113.00	108.28	119.50	113.20	127.00	114.35	127.91
40.8	94.13	102.75	99.20	108.00	103.27	113.00	108.33	119.50	113.23	127.00	114.63	128.23
40.9	94.17	102.78	99.25	108.00	103.31	113.00	108.37	119.50	113.26	127.00	114.91	128.54

Total (HP)	Outdoor unit capacity (kW)											
	RAS-32FSN2		RAS-34FSN2		RAS-36FSN2		RAS-38FSN2		RAS-40FSN2		RAS-42FSN2	
	Cooling	Heating	Cooling	Heating	Cooling	Heating	Cooling	Heating	Cooling	Heating	Cooling	Heating
41.0	94.22	102.81	99.29	108.00	103.36	113.00	108.42	119.50	113.28	127.00	115.19	128.86
41.1	94.27	102.84	99.34	108.00	103.41	113.00	108.47	119.50	113.31	127.00	115.47	129.17
41.2	94.31	102.88	99.39	108.00	103.46	113.00	108.52	119.50	113.34	127.00	115.75	129.49
41.3	94.36	102.91	99.44	108.00	103.50	113.00	108.56	119.50	113.37	127.00	116.03	129.80
41.4	94.41	102.94	99.48	108.00	103.55	113.00	108.61	119.50	113.40	127.00	116.31	130.11
41.5	94.45	102.97	99.53	108.00	103.60	113.00	108.66	119.50	113.43	127.00	116.60	130.43
41.6	94.50	103.00	99.58	108.00	103.64	113.00	108.71	119.50	113.45	127.00	116.88	130.74
41.7			99.62	108.00	103.69	113.00	108.75	119.50	113.48	127.00	117.16	131.06
41.8			99.67	108.00	103.74	113.00	108.80	119.50	113.51	127.00	117.44	131.37
41.9			99.72	108.00	103.79	113.00	108.85	119.50	113.54	127.00	117.72	131.69
42.0			99.76	108.00	103.83	113.00	108.89	119.50	113.57	127.00	118.00	132.00
42.1			99.81	108.00	103.88	113.00	108.94	119.50	113.60	127.00	118.03	132.00
42.2			99.86	108.00	103.93	113.00	108.99	119.50	113.62	127.00	118.06	132.00
42.3			99.91	108.00	103.98	113.00	109.04	119.50	113.65	127.00	118.08	132.00
42.4			99.95	108.00	104.02	113.00	109.08	119.50	113.68	127.00	118.11	132.00
42.5			100.00	108.00	104.07	113.00	109.13	119.50	113.71	127.00	118.14	132.00
42.6			100.05	108.00	104.12	113.00	109.18	119.50	113.74	127.00	118.17	132.00
42.7			100.09	108.00	104.16	113.00	109.23	119.50	113.77	127.00	118.19	132.00
42.8			100.14	108.00	104.21	113.00	109.27	119.50	113.79	127.00	118.22	132.00
42.9			100.19	108.00	104.26	113.00	109.32	119.50	113.82	127.00	118.25	132.00
43.0			100.24	108.00	104.31	113.00	109.37	119.50	113.85	127.00	118.28	132.00
43.1			100.28	108.00	104.35	113.00	109.42	119.50	113.88	127.00	118.31	132.00
43.2			100.33	108.00	104.40	113.00	109.46	119.50	113.91	127.00	118.33	132.00
43.3			100.38	108.00	104.45	113.00	109.51	119.50	113.94	127.00	118.36	132.00
43.4			100.42	108.00	104.49	113.00	109.56	119.50	113.96	127.00	118.39	132.00
43.5			100.47	108.00	104.54	113.00	109.61	119.50	113.99	127.00	118.42	132.00
43.6			100.52	108.00	104.59	113.00	109.65	119.50	114.02	127.00	118.44	132.00
43.7			100.56	108.00	104.64	113.00	109.70	119.50	114.05	127.00	118.47	132.00
43.8			100.61	108.00	104.68	113.00	109.75	119.50	114.08	127.00	118.50	132.00
43.9			100.66	108.00	104.73	113.00	109.79	119.50	114.11	127.00	118.53	132.00
44.0			100.71	108.00	104.78	113.00	109.84	119.50	114.13	127.00	118.56	132.00
44.1			100.75	108.00	104.83	113.00	109.89	119.50	114.16	127.00	118.58	132.00
44.2			100.80	108.00	104.87	113.00	109.94	119.50	114.19	127.00	118.61	132.00
44.3					104.92	113.00	109.98	119.50	114.22	127.00	118.64	132.00
44.4					104.97	113.00	110.03	119.50	114.25	127.00	118.67	132.00
44.5					105.01	113.00	110.08	119.50	114.28	127.00	118.69	132.00
44.6					105.06	113.00	110.13	119.50	114.30	127.00	118.72	132.00
44.7					105.11	113.00	110.17	119.50	114.33	127.00	118.75	132.00
44.8					105.16	113.00	110.22	119.50	114.36	127.00	118.78	132.00
44.9					105.20	113.00	110.27	119.50	114.39	127.00	118.81	132.00
45.0					105.25	113.00	110.32	119.50	114.42	127.00	118.83	132.00
45.1					105.30	113.00	110.36	119.50	114.45	127.00	118.86	132.00
45.2					105.34	113.00	110.41	119.50	114.47	127.00	118.89	132.00
45.3					105.39	113.00	110.46	119.50	114.50	127.00	118.92	132.00
45.4					105.44	113.00	110.51	119.50	114.53	127.00	118.94	132.00
45.5					105.49	113.00	110.55	119.50	114.56	127.00	118.97	132.00
45.6					105.53	113.00	110.60	119.50	114.59	127.00	119.00	132.00
45.7					105.58	113.00	110.65	119.50	114.62	127.00	119.03	132.00
45.8					105.63	113.00	110.69	119.50	114.64	127.00	119.06	132.00
45.9					105.68	113.00	110.74	119.50	114.67	127.00	119.08	132.00

Total (HP)	Outdoor unit capacity (kW)												
	RAS-32FSN2		RAS-34FSN2		RAS-36FSN2		RAS-38FSN2		RAS-40FSN2		RAS-42FSN2		
	Cooling	Heating	Cooling	Heating	Cooling	Heating	Cooling	Heating	Cooling	Heating	Cooling	Heating	
46.0					105.72	113.00	110.79	119.50	114.70	127.00	119.11	132.00	
46.1					105.77	113.00	110.84	119.50	114.73	127.00	119.14	132.00	
46.2					105.82	113.00	110.88	119.50	114.76	127.00	119.17	132.00	
46.3					105.86	113.00	110.93	119.50	114.79	127.00	119.19	132.00	
46.4					105.91	113.00	110.98	119.50	114.81	127.00	119.22	132.00	
46.5					105.96	113.00	111.03	119.50	114.84	127.00	119.25	132.00	
46.6					106.01	113.00	111.07	119.50	114.87	127.00	119.28	132.00	
46.7					106.05	113.00	111.12	119.50	114.90	127.00	119.31	132.00	
46.8					106.10	113.00	111.17	119.50	114.93	127.00	119.33	132.00	
46.9								111.22	119.50	114.96	127.00	119.36	132.00
47.0								111.26	119.50	114.98	127.00	119.39	132.00
47.1								111.31	119.50	115.01	127.00	119.42	132.00
47.2								111.36	119.50	115.04	127.00	119.44	132.00
47.3								111.41	119.50	115.07	127.00	119.47	132.00
47.4								111.45	119.50	115.10	127.00	119.50	132.00
47.5								111.50	119.50	115.13	127.00	119.53	132.00
47.6								111.55	119.50	115.15	127.00	119.56	132.00
47.7								111.59	119.50	115.18	127.00	119.58	132.00
47.8								111.64	119.50	115.21	127.00	119.61	132.00
47.9								111.69	119.50	115.24	127.00	119.64	132.00
48.0								111.74	119.50	115.27	127.00	119.67	132.00
48.1								111.78	119.50	115.30	127.00	119.69	132.00
48.2								111.83	119.50	115.32	127.00	119.72	132.00
48.3								111.88	119.50	115.35	127.00	119.75	132.00
48.4								111.93	119.50	115.38	127.00	119.78	132.00
48.5								111.97	119.50	115.41	127.00	119.81	132.00
48.6								112.02	119.50	115.44	127.00	119.83	132.00
48.7								112.07	119.50	115.47	127.00	119.86	132.00
48.8								112.12	119.50	115.49	127.00	119.89	132.00
48.9								112.16	119.50	115.52	127.00	119.92	132.00
49.0								112.21	119.50	115.55	127.00	119.94	132.00
49.1								112.26	119.50	115.58	127.00	119.97	132.00
49.2								112.31	119.50	115.61	127.00	120.00	132.00
49.3								112.35	119.50	115.64	127.00	120.03	132.00
49.4								112.40	119.50	115.66	127.00	120.06	132.00
49.5										115.69	127.00	120.08	132.00
49.6										115.72	127.00	120.11	132.00
49.7										115.75	127.00	120.14	132.00
49.8										115.78	127.00	120.17	132.00
49.9										115.81	127.00	120.19	132.00
50.0										115.83	127.00	120.22	132.00
50.1										115.86	127.00	120.25	132.00
50.2										115.89	127.00	120.28	132.00
50.3										115.92	127.00	120.31	132.00
50.4										115.95	127.00	120.33	132.00
50.5										115.98	127.00	120.36	132.00
50.6										116.00	127.00	120.39	132.00
50.7										116.03	127.00	120.42	132.00
50.8										116.06	127.00	120.44	132.00
50.9										116.09	127.00	120.47	132.00

Total (HP)	Outdoor unit capacity (kW)											
	RAS-32FSN2		RAS-34FSN2		RAS-36FSN2		RAS-38FSN2		RAS-40FSN2		RAS-42FSN2	
	Cooling	Heating	Cooling	Heating	Cooling	Heating	Cooling	Heating	Cooling	Heating	Cooling	Heating
51.0									116.12	127.00	120.50	132.00
51.1									116.15	127.00	120.53	132.00
51.2									116.17	127.00	120.56	132.00
51.3									116.20	127.00	120.58	132.00
51.4									116.23	127.00	120.61	132.00
51.5									116.26	127.00	120.64	132.00
51.6									116.29	127.00	120.67	132.00
51.7									116.32	127.00	120.69	132.00
51.8									116.34	127.00	120.72	132.00
51.9									116.37	127.00	120.75	132.00
52.0									116.40	127.00	120.78	132.00
52.1											120.81	132.00
52.2											120.83	132.00
52.3											120.86	132.00
52.4											120.89	132.00
52.5											120.92	132.00
52.6											120.94	132.00
52.7											120.97	132.00
52.8	-		-		-		-				121.00	132.00
52.9											121.03	132.00
53.0											121.06	132.00
53.1											121.08	132.00
53.2											121.11	132.00
53.3											121.14	132.00
53.4											121.17	132.00
53.5											121.19	132.00
53.6											121.22	132.00
53.7											121.25	132.00
53.8											121.28	132.00
53.9											121.31	132.00
54.0											121.33	132.00
54.1											121.36	132.00
54.2											121.39	132.00
54.3											121.42	132.00
54.4											121.44	132.00
54.5											121.47	132.00
54.6											121.50	132.00

4

◆ RAS-44~48FSN2

Total (HP)	Outdoor unit capacity (kW)					
	RAS-44FSN2		RAS-46FSN2		RAS-48FSN2	
	Cooling	Heating	Cooling	Heating	Cooling	Heating
22.0	62.00	69.00				
22.1	62.28	69.31				
22.2	62.56	69.63				
22.3	62.85	69.94				
22.4	63.13	70.25				
22.5	63.41	70.57				
22.6	63.69	70.88				
22.7	63.97	71.20				
22.8	64.25	71.51				
22.9	64.54	71.82				
23.0	64.82	72.14	65.00	72.50		
23.1	65.10	72.45	65.28	72.82		
23.2	65.38	72.76	65.57	73.13		
23.3	65.66	73.08	65.85	73.45		
23.4	65.95	73.39	66.13	73.76		
23.5	66.23	73.70	66.41	74.08		
23.6	66.51	74.02	66.70	74.39		
23.7	66.79	74.33	66.98	74.71		
23.8	67.07	74.65	67.26	75.02		
23.9	67.35	74.96	67.54	75.34		
24.0	67.64	75.27	67.83	75.65	67.50	75.00
24.1	67.92	75.59	68.11	75.97	67.78	75.31
24.2	68.20	75.90	68.39	76.28	68.06	75.63
24.3	68.48	76.21	68.67	76.60	68.34	75.94
24.4	68.76	76.53	68.96	76.91	68.63	76.25
24.5	69.05	76.84	69.24	77.23	68.91	76.56
24.6	69.33	77.15	69.52	77.54	69.19	76.88
24.7	69.61	77.47	69.80	77.86	69.47	77.19
24.8	69.89	77.78	70.09	78.17	69.75	77.50
24.9	70.17	78.10	70.37	78.49	70.03	77.81
25.0	70.45	78.41	70.65	78.80	70.31	78.13
25.1	70.74	78.72	70.93	79.12	70.59	78.44
25.2	71.02	79.04	71.22	79.43	70.88	78.75
25.3	71.30	79.35	71.50	79.75	71.16	79.06
25.4	71.58	79.66	71.78	80.07	71.44	79.38
25.5	71.86	79.98	72.07	80.38	71.72	79.69
25.6	72.15	80.29	72.35	80.70	72.00	80.00
25.7	72.43	80.60	72.63	81.01	72.28	80.31
25.8	72.71	80.92	72.91	81.33	72.56	80.63
25.9	72.99	81.23	73.20	81.64	72.84	80.94
26.0	73.27	81.55	73.48	81.96	73.13	81.25
26.1	73.55	81.86	73.76	82.27	73.41	81.56
26.2	73.84	82.17	74.04	82.59	73.69	81.88
26.3	74.12	82.49	74.33	82.90	73.97	82.19
26.4	74.40	82.80	74.61	83.22	74.25	82.50
26.5	74.68	83.11	74.89	83.53	74.53	82.81
26.6	74.96	83.43	75.17	83.85	74.81	83.13
26.7	75.25	83.74	75.46	84.16	75.09	83.44
26.8	75.53	84.05	75.74	84.48	75.38	83.75
26.9	75.81	84.37	76.02	84.79	75.66	84.06

Total (HP)	Outdoor unit capacity (kW)					
	RAS-44FSN2		RAS-46FSN2		RAS-48FSN2	
	Cooling	Heating	Cooling	Heating	Cooling	Heating
27.0	76.09	84.68	76.30	85.11	75.94	84.38
27.1	76.37	85.00	76.59	85.42	76.22	84.69
27.2	76.65	85.31	76.87	85.74	76.50	85.00
27.3	76.94	85.62	77.15	86.05	76.78	85.31
27.4	77.22	85.94	77.43	86.37	77.06	85.63
27.5	77.50	86.25	77.72	86.68	77.34	85.94
27.6	77.78	86.56	78.00	87.00	77.63	86.25
27.7	78.06	86.88	78.28	87.32	77.91	86.56
27.8	78.35	87.19	78.57	87.63	78.19	86.88
27.9	78.63	87.50	78.85	87.95	78.47	87.19
28.0	78.91	87.82	79.13	88.26	78.75	87.50
28.1	79.19	88.13	79.41	88.58	79.03	87.81
28.2	79.47	88.45	79.70	88.89	79.31	88.12
28.3	79.75	88.76	79.98	89.21	79.59	88.44
28.4	80.04	89.07	80.26	89.52	79.87	88.75
28.5	80.32	89.39	80.54	89.84	80.16	89.06
28.6	80.60	89.70	80.83	90.15	80.44	89.37
28.7	80.88	90.01	81.11	90.47	80.72	89.69
28.8	81.16	90.33	81.39	90.78	81.00	90.00
28.9	81.45	90.64	81.67	91.10	81.28	90.31
29.0	81.73	90.95	81.96	91.41	81.56	90.62
29.1	82.01	91.27	82.24	91.73	81.84	90.94
29.2	82.29	91.58	82.52	92.04	82.12	91.25
29.3	82.57	91.90	82.80	92.36	82.41	91.56
29.4	82.85	92.21	83.09	92.67	82.69	91.87
29.5	83.14	92.52	83.37	92.99	82.97	92.19
29.6	83.42	92.84	83.65	93.30	83.25	92.50
29.7	83.70	93.15	83.93	93.62	83.53	92.81
29.8	83.98	93.46	84.22	93.93	83.81	93.12
29.9	84.26	93.78	84.50	94.25	84.09	93.44
30.0	84.55	94.09	84.78	94.57	84.37	93.75
30.1	84.83	94.40	85.07	94.88	84.66	94.06
30.2	85.11	94.72	85.35	95.20	84.94	94.37
30.3	85.39	95.03	85.63	95.51	85.22	94.69
30.4	85.67	95.35	85.91	95.83	85.50	95.00
30.5	85.95	95.66	86.20	96.14	85.78	95.31
30.6	86.24	95.97	86.48	96.46	86.06	95.62
30.7	86.52	96.29	86.76	96.77	86.34	95.94
30.8	86.80	96.60	87.04	97.09	86.62	96.25
30.9	87.08	96.91	87.33	97.40	86.91	96.56
31.0	87.36	97.23	87.61	97.72	87.19	96.87
31.1	87.65	97.54	87.89	98.03	87.47	97.19
31.2	87.93	97.85	88.17	98.35	87.75	97.50
31.3	88.21	98.17	88.46	98.66	88.03	97.81
31.4	88.49	98.48	88.74	98.98	88.31	98.12
31.5	88.77	98.80	89.02	99.29	88.59	98.44
31.6	89.05	99.11	89.30	99.61	88.87	98.75
31.7	89.34	99.42	89.59	99.92	89.16	99.06
31.8	89.62	99.74	89.87	100.24	89.44	99.37
31.9	89.90	100.05	90.15	100.55	89.72	99.69

Total (HP)	Outdoor unit capacity (kW)					
	RAS-44FSN2		RAS-46FSN2		RAS-48FSN2	
	Cooling	Heating	Cooling	Heating	Cooling	Heating
32.0	90.18	100.36	90.43	100.87	90.00	100.00
32.1	90.46	100.68	90.72	101.18	90.28	100.31
32.2	90.75	100.99	91.00	101.50	90.56	100.63
32.3	91.03	101.30	91.28	101.82	90.84	100.94
32.4	91.31	101.62	91.57	102.13	91.12	101.25
32.5	91.59	101.93	91.85	102.45	91.41	101.56
32.6	91.87	102.25	92.13	102.76	91.69	101.88
32.7	92.15	102.56	92.41	103.08	91.97	102.19
32.8	92.44	102.87	92.70	103.39	92.25	102.50
32.9	92.72	103.19	92.98	103.71	92.53	102.81
33.0	93.00	103.50	93.26	104.02	92.81	103.13
33.1	93.28	103.81	93.54	104.34	93.09	103.44
33.2	93.56	104.13	93.83	104.65	93.37	103.75
33.3	93.85	104.44	94.11	104.97	93.66	104.06
33.4	94.13	104.75	94.39	105.28	93.94	104.38
33.5	94.41	105.07	94.67	105.60	94.22	104.69
33.6	94.69	105.38	94.96	105.91	94.50	105.00
33.7	94.97	105.70	95.24	106.23	94.78	105.31
33.8	95.25	106.01	95.52	106.54	95.06	105.63
33.9	95.54	106.32	95.80	106.86	95.34	105.94
34.0	95.82	106.64	96.09	107.17	95.62	106.25
34.1	96.10	106.95	96.37	107.49	95.91	106.56
34.2	96.38	107.26	96.65	107.80	96.19	106.88
34.3	96.66	107.58	96.93	108.12	96.47	107.19
34.4	96.95	107.89	97.22	108.43	96.75	107.50
34.5	97.23	108.20	97.50	108.75	97.03	107.81
34.6	97.51	108.52	97.78	109.07	97.31	108.13
34.7	97.79	108.83	98.07	109.38	97.59	108.44
34.8	98.07	109.15	98.35	109.70	97.87	108.75
34.9	98.35	109.46	98.63	110.01	98.16	109.06
35.0	98.64	109.77	98.91	110.33	98.44	109.38
35.1	98.92	110.09	99.20	110.64	98.72	109.69
35.2	99.20	110.40	99.48	110.96	99.00	110.00
35.3	99.48	110.71	99.76	111.27	99.28	110.31
35.4	99.76	111.03	100.04	111.59	99.56	110.63
35.5	100.05	111.34	100.33	111.90	99.84	110.94
35.6	100.33	111.65	100.61	112.22	100.13	111.25
35.7	100.61	111.97	100.89	112.53	100.41	111.56
35.8	100.89	112.28	101.17	112.85	100.69	111.88
35.9	101.17	112.60	101.46	113.16	100.97	112.19
36.0	101.45	112.91	101.74	113.48	101.25	112.50
36.1	101.74	113.22	102.02	113.79	101.53	112.81
36.2	102.02	113.54	102.30	114.11	101.81	113.13
36.3	102.30	113.85	102.59	114.42	102.09	113.44
36.4	102.58	114.16	102.87	114.74	102.38	113.75
36.5	102.86	114.48	103.15	115.05	102.66	114.06
36.6	103.15	114.79	103.43	115.37	102.94	114.38
36.7	103.43	115.10	103.72	115.68	103.22	114.69
36.8	103.71	115.42	104.00	116.00	103.50	115.00
36.9	103.99	115.73	104.28	116.32	103.78	115.31

Total (HP)	Outdoor unit capacity (kW)					
	RAS-44FSN2		RAS-46FSN2		RAS-48FSN2	
	Cooling	Heating	Cooling	Heating	Cooling	Heating
37.0	104.27	116.05	104.57	116.63	104.06	115.63
37.1	104.55	116.36	104.85	116.95	104.34	115.94
37.2	104.84	116.67	105.13	117.26	104.63	116.25
37.3	105.12	116.99	105.41	117.58	104.91	116.56
37.4	105.40	117.30	105.70	117.89	105.19	116.88
37.5	105.68	117.61	105.98	118.21	105.47	117.19
37.6	105.96	117.93	106.26	118.52	105.75	117.50
37.7	106.25	118.24	106.54	118.84	106.03	117.81
37.8	106.53	118.55	106.83	119.15	106.31	118.13
37.9	106.81	118.87	107.11	119.47	106.59	118.44
38.0	107.09	119.18	107.39	119.78	106.88	118.75
38.1	107.37	119.50	107.67	120.10	107.16	119.06
38.2	107.65	119.81	107.96	120.41	107.44	119.38
38.3	107.94	120.12	108.24	120.73	107.72	119.69
38.4	108.22	120.44	108.52	121.04	108.00	120.00
38.5	108.50	120.75	108.80	121.36	108.28	120.31
38.6	108.78	121.06	109.09	121.67	108.56	120.63
38.7	109.06	121.38	109.37	121.99	108.84	120.94
38.8	109.35	121.69	109.65	122.30	109.13	121.25
38.9	109.63	122.00	109.93	122.62	109.41	121.56
39.0	109.91	122.32	110.22	122.93	109.69	121.88
39.1	110.19	122.63	110.50	123.25	109.97	122.19
39.2	110.47	122.95	110.78	123.57	110.25	122.50
39.3	110.75	123.26	111.07	123.88	110.53	122.81
39.4	111.04	123.57	111.35	124.20	110.81	123.13
39.5	111.32	123.89	111.63	124.51	111.09	123.44
39.6	111.60	124.20	111.91	124.83	111.38	123.75
39.7	111.88	124.51	112.20	125.14	111.66	124.06
39.8	112.16	124.83	112.48	125.46	111.94	124.38
39.9	112.45	125.14	112.76	125.77	112.22	124.69
40.0	112.73	125.45	113.04	126.09	112.50	125.00
40.1	113.01	125.77	113.33	126.40	112.78	125.31
40.2	113.29	126.08	113.61	126.72	113.06	125.63
40.3	113.57	126.40	113.89	127.03	113.34	125.94
40.4	113.85	126.71	114.17	127.35	113.63	126.25
40.5	114.14	127.02	114.46	127.66	113.91	126.56
40.6	114.42	127.34	114.74	127.98	114.19	126.88
40.7	114.70	127.65	115.02	128.29	114.47	127.19
40.8	114.98	127.96	115.30	128.61	114.75	127.50
40.9	115.26	128.28	115.59	128.92	115.03	127.81
41.0	115.55	128.59	115.87	129.24	115.31	128.13
41.1	115.83	128.90	116.15	129.55	115.59	128.44
41.2	116.11	129.22	116.43	129.87	115.88	128.75
41.3	116.39	129.53	116.72	130.18	116.16	129.06
41.4	116.67	129.85	117.00	130.50	116.44	129.38
41.5	116.95	130.16	117.28	130.82	116.72	129.69
41.6	117.24	130.47	117.57	131.13	117.00	130.00
41.7	117.52	130.79	117.85	131.45	117.28	130.31
41.8	117.80	131.10	118.13	131.76	117.56	130.63
41.9	118.08	131.41	118.41	132.08	117.84	130.94

Total (HP)	Outdoor unit capacity (kW)					
	RAS-44FSN2		RAS-46FSN2		RAS-48FSN2	
	Cooling	Heating	Cooling	Heating	Cooling	Heating
42.0	118.36	131.73	118.70	132.39	118.13	131.25
42.1	118.65	132.04	118.98	132.71	118.41	131.56
42.2	118.93	132.35	119.26	133.02	118.69	131.88
42.3	119.21	132.67	119.54	133.34	118.97	132.19
42.4	119.49	132.98	119.83	133.65	119.25	132.50
42.5	119.77	133.30	120.11	133.97	119.53	132.81
42.6	120.05	133.61	120.39	134.28	119.81	133.13
42.7	120.34	133.92	120.67	134.60	120.09	133.44
42.8	120.62	134.24	120.96	134.91	120.38	133.75
42.9	120.90	134.55	121.24	135.23	120.66	134.06
43.0	121.18	134.86	121.52	135.54	120.94	134.38
43.1	121.46	135.18	121.80	135.86	121.22	134.69
43.2	121.75	135.49	122.09	136.17	121.50	135.00
43.3	122.03	135.80	122.37	136.49	121.78	135.31
43.4	122.31	136.12	122.65	136.80	122.06	135.63
43.5	122.59	136.43	122.93	137.12	122.34	135.94
43.6	122.87	136.75	123.22	137.43	122.63	136.25
43.7	123.15	137.06	123.50	137.75	122.91	136.56
43.8	123.44	137.37	123.78	138.07	123.19	136.88
43.9	123.72	137.69	124.07	138.38	123.47	137.19
44.0	124.00	138.00	124.35	138.70	123.75	137.50
44.1	124.03	138.00	124.63	139.01	124.03	137.81
44.2	124.06	138.00	124.91	139.33	124.31	138.13
44.3	124.08	138.00	125.20	139.64	124.59	138.44
44.4	124.11	138.00	125.48	139.96	124.88	138.75
44.5	124.14	138.00	125.76	140.27	125.16	139.06
44.6	124.17	138.00	126.04	140.59	125.44	139.38
44.7	124.20	138.00	126.33	140.90	125.72	139.69
44.8	124.22	138.00	126.61	141.22	126.00	140.00
44.9	124.25	138.00	126.89	141.53	126.28	140.31
45.0	124.28	138.00	127.17	141.85	126.56	140.63
45.1	124.31	138.00	127.46	142.16	126.84	140.94
45.2	124.34	138.00	127.74	142.48	127.13	141.25
45.3	124.36	138.00	128.02	142.79	127.41	141.56
45.4	124.39	138.00	128.30	143.11	127.69	141.88
45.5	124.42	138.00	128.59	143.42	127.97	142.19
45.6	124.45	138.00	128.87	143.74	128.25	142.50
45.7	124.48	138.00	129.15	144.05	128.53	142.81
45.8	124.50	138.00	129.43	144.37	128.81	143.13
45.9	124.53	138.00	129.72	144.68	129.09	143.44
46.0	124.56	138.00	130.00	145.00	129.38	143.75
46.1	124.59	138.00	130.03	145.00	129.66	144.06
46.2	124.62	138.00	130.06	145.00	129.94	144.38
46.3	124.64	138.00	130.08	145.00	130.22	144.69
46.4	124.67	138.00	130.11	145.00	130.50	145.00
46.5	124.70	138.00	130.14	145.00	130.78	145.31
46.6	124.73	138.00	130.17	145.00	131.06	145.63
46.7	124.76	138.00	130.20	145.00	131.34	145.94
46.8	124.78	138.00	130.23	145.00	131.63	146.25
46.9	124.81	138.00	130.25	145.00	131.91	146.56

Total (HP)	Outdoor unit capacity (kW)					
	RAS-44FSN2		RAS-46FSN2		RAS-48FSN2	
	Cooling	Heating	Cooling	Heating	Cooling	Heating
47.0	124.84	138.00	130.28	145.00	132.19	146.88
47.1	124.87	138.00	130.31	145.00	132.47	147.19
47.2	124.90	138.00	130.34	145.00	132.75	147.50
47.3	124.93	138.00	130.37	145.00	133.03	147.81
47.4	124.95	138.00	130.40	145.00	133.31	148.13
47.5	124.98	138.00	130.42	145.00	133.59	148.44
47.6	125.01	138.00	130.45	145.00	133.88	148.75
47.7	125.04	138.00	130.48	145.00	134.16	149.06
47.8	125.07	138.00	130.51	145.00	134.44	149.38
47.9	125.09	138.00	130.54	145.00	134.72	149.69
48.0	125.12	138.00	130.57	145.00	135.00	150.00
48.1	125.15	138.00	130.59	145.00	135.03	150.00
48.2	125.18	138.00	130.62	145.00	135.06	150.00
48.3	125.21	138.00	130.65	145.00	135.09	150.00
48.4	125.23	138.00	130.68	145.00	135.11	150.00
48.5	125.26	138.00	130.71	145.00	135.14	150.00
48.6	125.29	138.00	130.73	145.00	135.17	150.00
48.7	125.32	138.00	130.76	145.00	135.20	150.00
48.8	125.35	138.00	130.79	145.00	135.23	150.00
48.9	125.37	138.00	130.82	145.00	135.26	150.00
49.0	125.40	138.00	130.85	145.00	135.28	150.00
49.1	125.43	138.00	130.88	145.00	135.31	150.00
49.2	125.46	138.00	130.90	145.00	135.34	150.00
49.3	125.49	138.00	130.93	145.00	135.37	150.00
49.4	125.51	138.00	130.96	145.00	135.40	150.00
49.5	125.54	138.00	130.99	145.00	135.43	150.00
49.6	125.57	138.00	131.02	145.00	135.46	150.00
49.7	125.60	138.00	131.05	145.00	135.48	150.00
49.8	125.63	138.00	131.07	145.00	135.51	150.00
49.9	125.65	138.00	131.10	145.00	135.54	150.00
50.0	125.68	138.00	131.13	145.00	135.57	150.00
50.1	125.71	138.00	131.16	145.00	135.60	150.00
50.2	125.74	138.00	131.19	145.00	135.63	150.00
50.3	125.77	138.00	131.22	145.00	135.65	150.00
50.4	125.79	138.00	131.24	145.00	135.68	150.00
50.5	125.82	138.00	131.27	145.00	135.71	150.00
50.6	125.85	138.00	131.30	145.00	135.74	150.00
50.7	125.88	138.00	131.33	145.00	135.77	150.00
50.8	125.91	138.00	131.36	145.00	135.80	150.00
50.9	125.93	138.00	131.38	145.00	135.83	150.00
51.0	125.96	138.00	131.41	145.00	135.85	150.00
51.1	125.99	138.00	131.44	145.00	135.88	150.00
51.2	126.02	138.00	131.47	145.00	135.91	150.00
51.3	126.05	138.00	131.50	145.00	135.94	150.00
51.4	126.07	138.00	131.53	145.00	135.97	150.00
51.5	126.10	138.00	131.55	145.00	136.00	150.00
51.6	126.13	138.00	131.58	145.00	136.03	150.00
51.7	126.16	138.00	131.61	145.00	136.05	150.00
51.8	126.19	138.00	131.64	145.00	136.08	150.00
51.9	126.21	138.00	131.67	145.00	136.11	150.00

Total (HP)	Outdoor unit capacity (kW)					
	RAS-44FSN2		RAS-46FSN2		RAS-48FSN2	
	Cooling	Heating	Cooling	Heating	Cooling	Heating
52.0	126.24	138.00	131.70	145.00	136.14	150.00
52.1	126.27	138.00	131.72	145.00	136.17	150.00
52.2	126.30	138.00	131.75	145.00	136.20	150.00
52.3	126.33	138.00	131.78	145.00	136.22	150.00
52.4	126.35	138.00	131.81	145.00	136.25	150.00
52.5	126.38	138.00	131.84	145.00	136.28	150.00
52.6	126.41	138.00	131.87	145.00	136.31	150.00
52.7	126.44	138.00	131.89	145.00	136.34	150.00
52.8	126.47	138.00	131.92	145.00	136.37	150.00
52.9	126.49	138.00	131.95	145.00	136.40	150.00
53.0	126.52	138.00	131.98	145.00	136.42	150.00
53.1	126.55	138.00	132.01	145.00	136.45	150.00
53.2	126.58	138.00	132.03	145.00	136.48	150.00
53.3	126.61	138.00	132.06	145.00	136.51	150.00
53.4	126.63	138.00	132.09	145.00	136.54	150.00
53.5	126.66	138.00	132.12	145.00	136.57	150.00
53.6	126.69	138.00	132.15	145.00	136.59	150.00
53.7	126.72	138.00	132.18	145.00	136.62	150.00
53.8	126.75	138.00	132.20	145.00	136.65	150.00
53.9	126.78	138.00	132.23	145.00	136.68	150.00
54.0	126.80	138.00	132.26	145.00	136.71	150.00
54.1	126.83	138.00	132.29	145.00	136.74	150.00
54.2	126.86	138.00	132.32	145.00	136.77	150.00
54.3	126.89	138.00	132.35	145.00	136.79	150.00
54.4	126.92	138.00	132.37	145.00	136.82	150.00
54.5	126.94	138.00	132.40	145.00	136.85	150.00
54.6	126.97	138.00	132.43	145.00	136.88	150.00
54.7	127.00	138.00	132.46	145.00	136.91	150.00
54.8	127.03	138.00	132.49	145.00	136.94	150.00
54.9	127.06	138.00	132.52	145.00	136.96	150.00
55.0	127.08	138.00	132.54	145.00	136.99	150.00
55.1	127.11	138.00	132.57	145.00	137.02	150.00
55.2	127.14	138.00	132.60	145.00	137.05	150.00
55.3	127.17	138.00	132.63	145.00	137.08	150.00
55.4	127.20	138.00	132.66	145.00	137.11	150.00
55.5	127.22	138.00	132.68	145.00	137.14	150.00
55.6	127.25	138.00	132.71	145.00	137.16	150.00
55.7	127.28	138.00	132.74	145.00	137.19	150.00
55.8	127.31	138.00	132.77	145.00	137.22	150.00
55.9	127.34	138.00	132.80	145.00	137.25	150.00
56.0	127.36	138.00	132.83	145.00	137.28	150.00
56.1	127.39	138.00	132.85	145.00	137.31	150.00
56.2	127.42	138.00	132.88	145.00	137.33	150.00
56.3	127.45	138.00	132.91	145.00	137.36	150.00
56.4	127.48	138.00	132.94	145.00	137.39	150.00
56.5	127.50	138.00	132.97	145.00	137.42	150.00
56.6	127.53	138.00	133.00	145.00	137.45	150.00
56.7	127.56	138.00	133.02	145.00	137.48	150.00
56.8	127.59	138.00	133.05	145.00	137.51	150.00
56.9	127.62	138.00	133.08	145.00	137.53	150.00
57.0	127.64	138.00	133.11	145.00	137.56	150.00
57.1	127.67	138.00	133.14	145.00	137.59	150.00
57.2	127.70	138.00	133.17	145.00	137.62	150.00

Total (HP)	Outdoor unit capacity (kW)					
	RAS-44FSN2		RAS-46FSN2		RAS-48FSN2	
	Cooling	Heating	Cooling	Heating	Cooling	Heating
57.3			133.19	145.00	137.65	150.00
57.4			133.22	145.00	137.68	150.00
57.5			133.25	145.00	137.70	150.00
57.6			133.28	145.00	137.73	150.00
57.7			133.31	145.00	137.76	150.00
57.8			133.33	145.00	137.79	150.00
57.9			133.36	145.00	137.82	150.00
58.0			133.39	145.00	137.85	150.00
58.1			133.42	145.00	137.88	150.00
58.2			133.45	145.00	137.90	150.00
58.3			133.48	145.00	137.93	150.00
58.4			133.50	145.00	137.96	150.00
58.5			133.53	145.00	137.99	150.00
58.6			133.56	145.00	138.02	150.00
58.7			133.59	145.00	138.05	150.00
58.8			133.62	145.00	138.08	150.00
58.9			133.65	145.00	138.10	150.00
59.0			133.67	145.00	138.13	150.00
59.1			133.70	145.00	138.16	150.00
59.2			133.73	145.00	138.19	150.00
59.3			133.76	145.00	138.22	150.00
59.4			133.79	145.00	138.25	150.00
59.5			133.82	145.00	138.27	150.00
59.6			133.84	145.00	138.30	150.00
59.7			133.87	145.00	138.33	150.00
59.8			133.90	145.00	138.36	150.00
59.9					138.39	150.00
60.0					138.42	150.00
60.1					138.45	150.00
60.2					138.47	150.00
60.3					138.50	150.00
60.4					138.53	150.00
60.5					138.56	150.00
60.6					138.59	150.00
60.7					138.62	150.00
60.8					138.64	150.00
60.9					138.67	150.00
61.0					138.70	150.00
61.1					138.73	150.00
61.2					138.76	150.00
61.3					138.79	150.00
61.4					138.82	150.00
61.5					138.84	150.00
61.6					138.87	150.00
61.7					138.90	150.00
61.8					138.93	150.00
61.9					138.96	150.00
62.0					138.99	150.00
62.1					139.01	150.00
62.2					139.04	150.00
62.3					139.07	150.00
62.4					139.10	150.00

4.3. Capacity characteristic curve

The following charts show the characteristics of outdoor unit capacity which corresponds with total horsepower of combined indoor unit, on standard condition with refrigerant piping of horizontal and 7.5m at length.
See chapter "Outdoor unit capacity with total horsepower of combined indoor unit" for the examples of the actual combinations

◆ Cooling characteristic curve of RAS-8FSN2

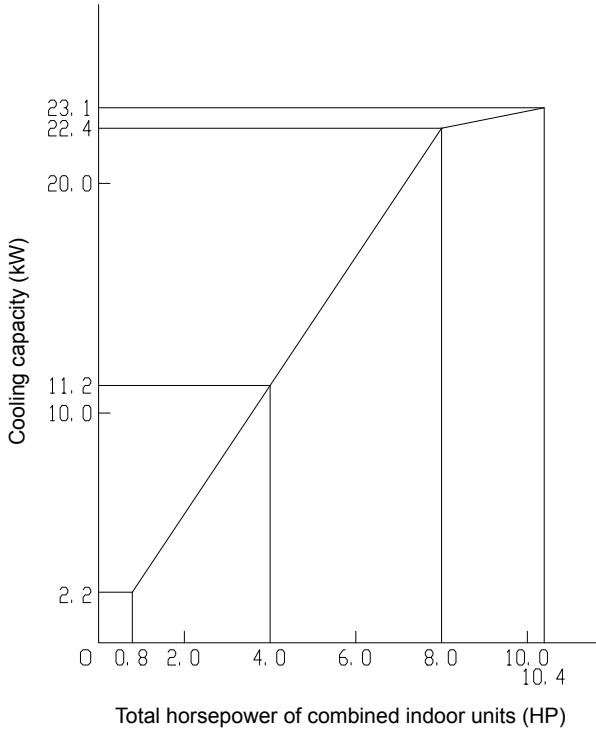

◆ Heating characteristic curve of RAS-8FSN2

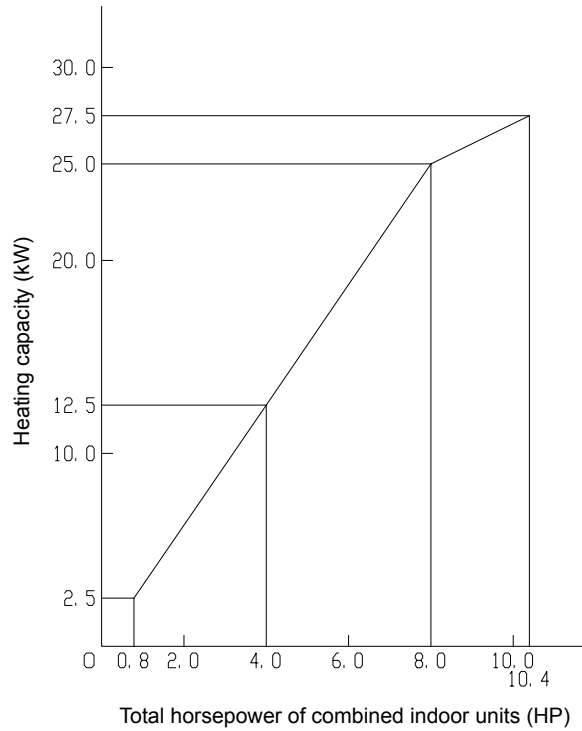

◆ Cooling characteristic curve of RAS-10FSN2

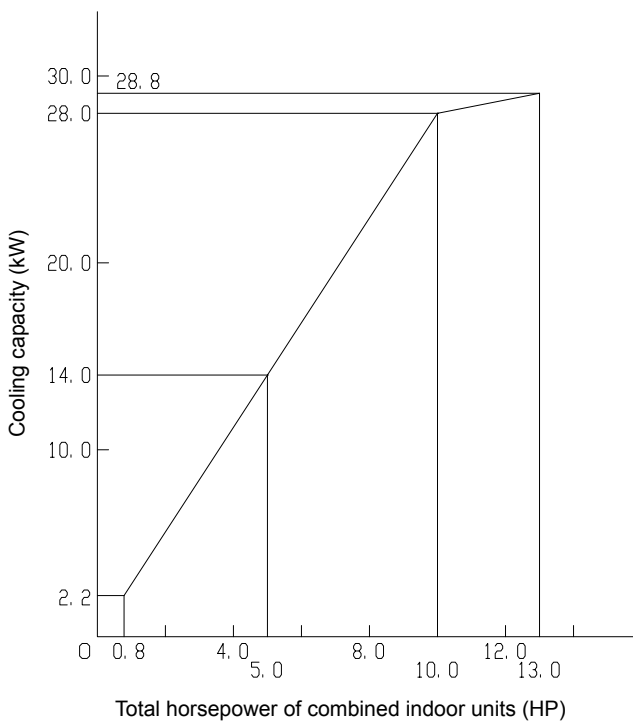

◆ Heating characteristic curve of RAS-10FSN2

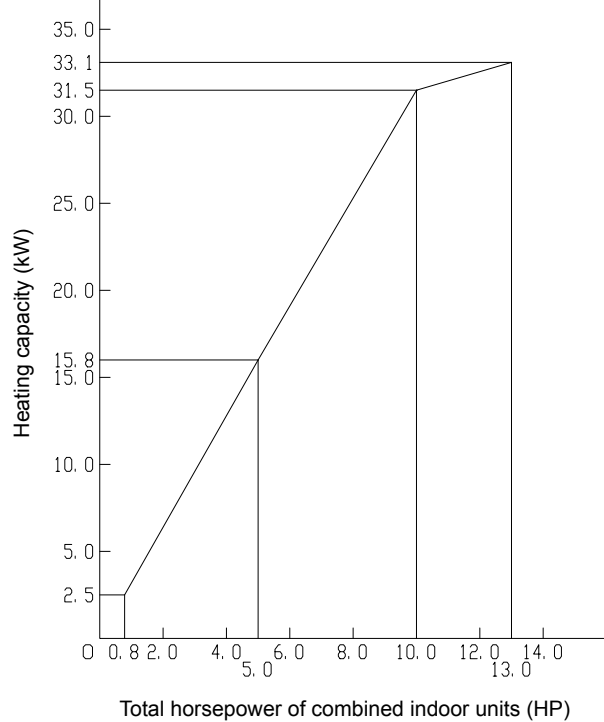

◆ Cooling characteristic curve of RAS-12FSN2

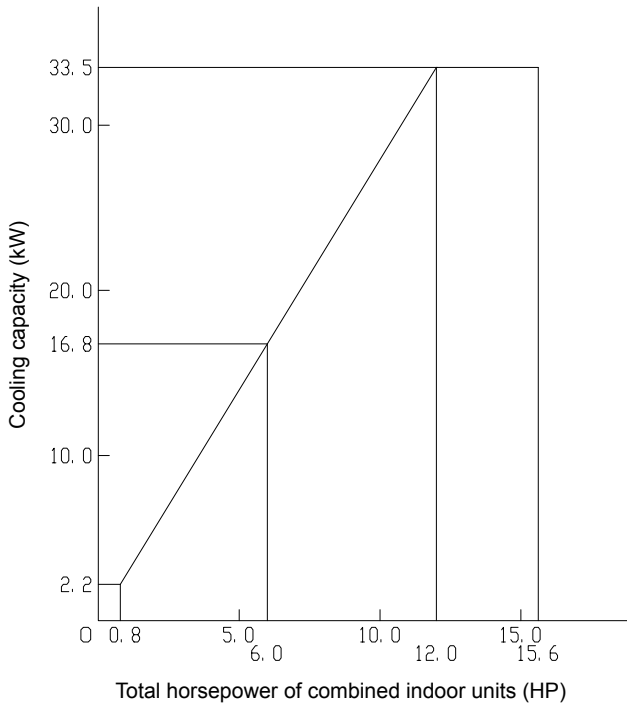

◆ Heating characteristic curve of RAS-12FSN2

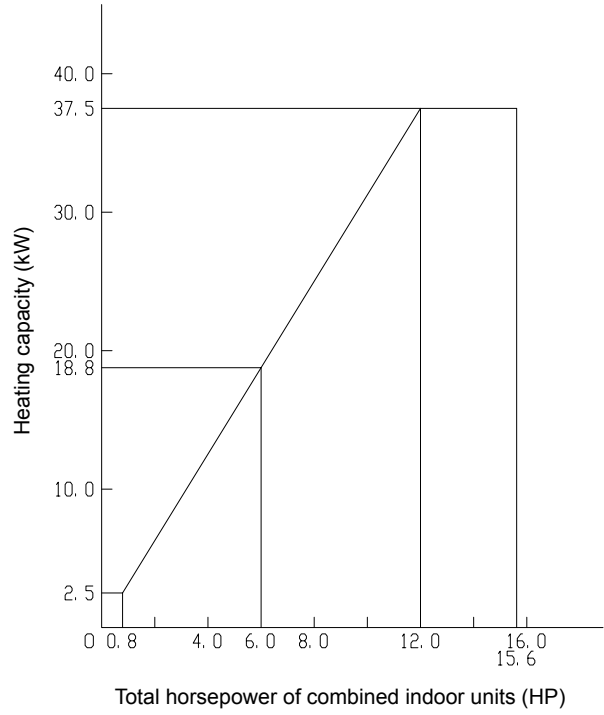

◆ Cooling characteristic curve of RAS-14FSN2

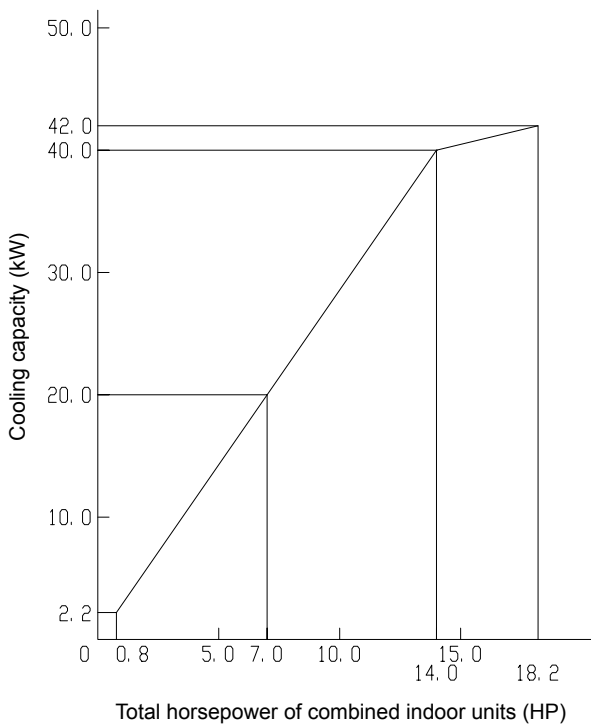

◆ Heating characteristic curve of RAS-14FSN2

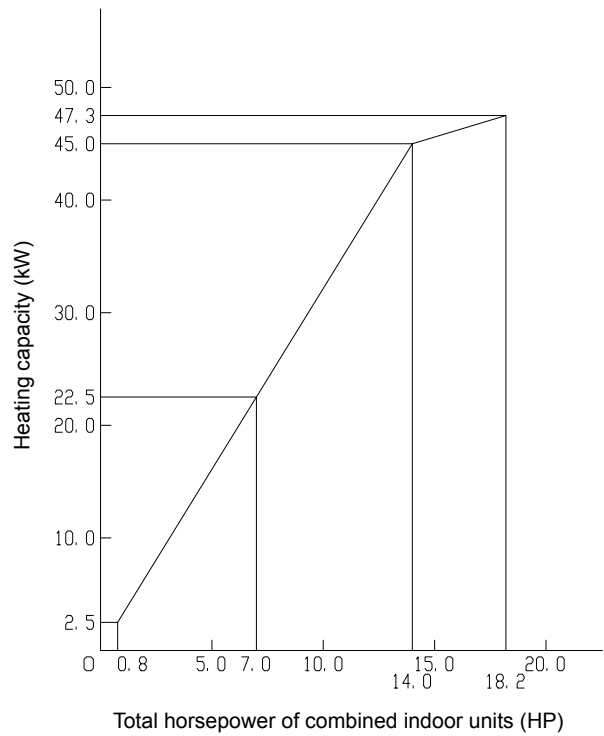

◆ Cooling characteristic curve of RAS-16FSN2

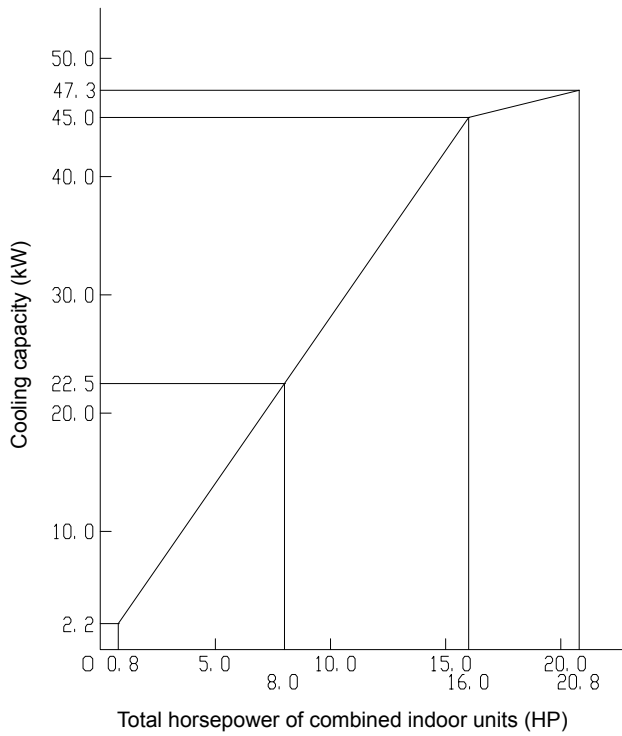

◆ Heating characteristic curve of RAS-16FSN2

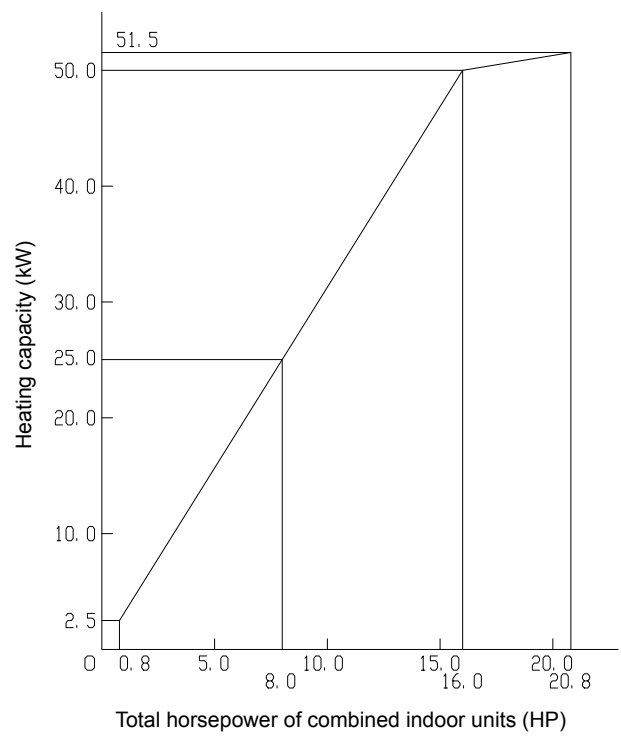

◆ Cooling characteristic curve of RAS-18FSN2

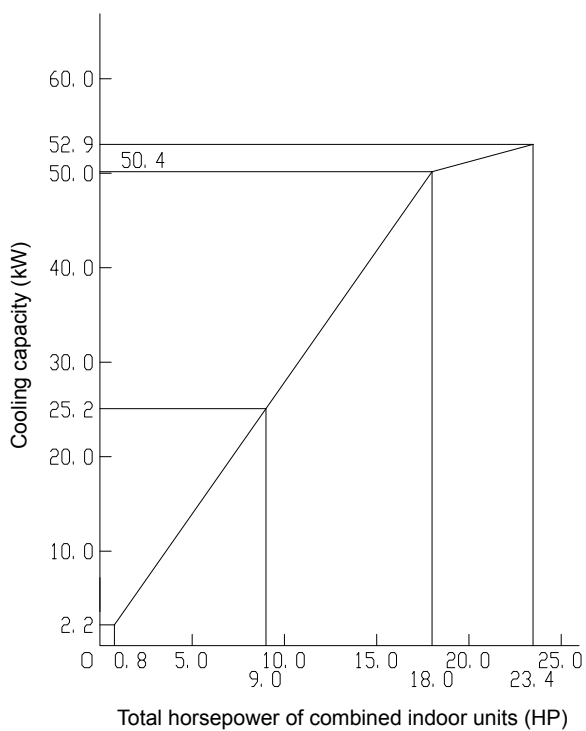

◆ Heating characteristic curve of RAS-18FSN2

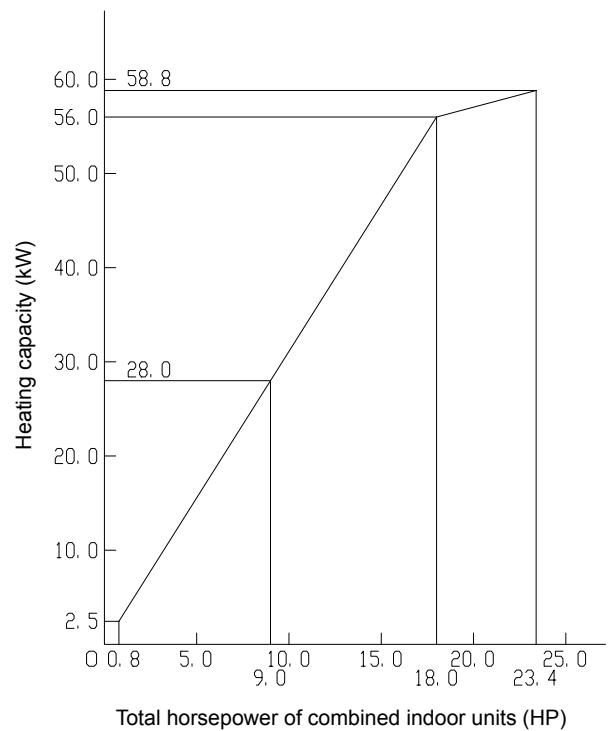

◆ Cooling characteristic curve of RAS-20FSN2

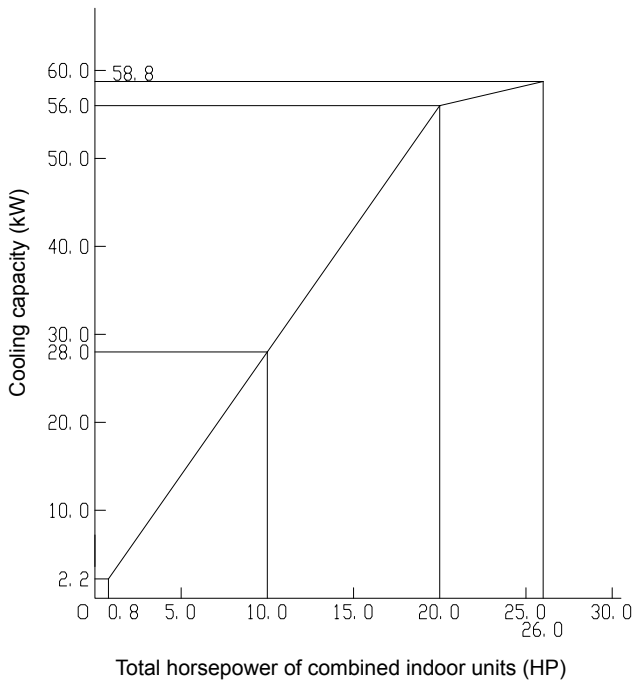

◆ Heating characteristic curve of RAS-20FSN2

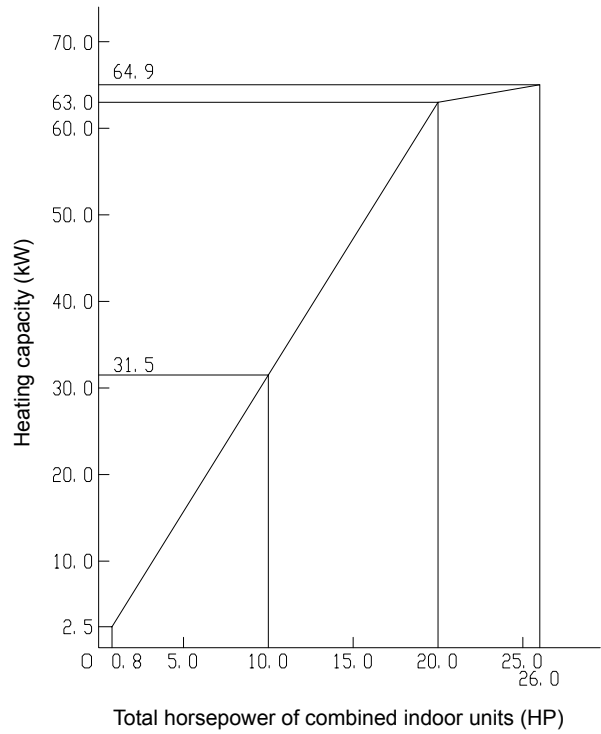

4

◆ Cooling characteristic curve of RAS-22FSN2

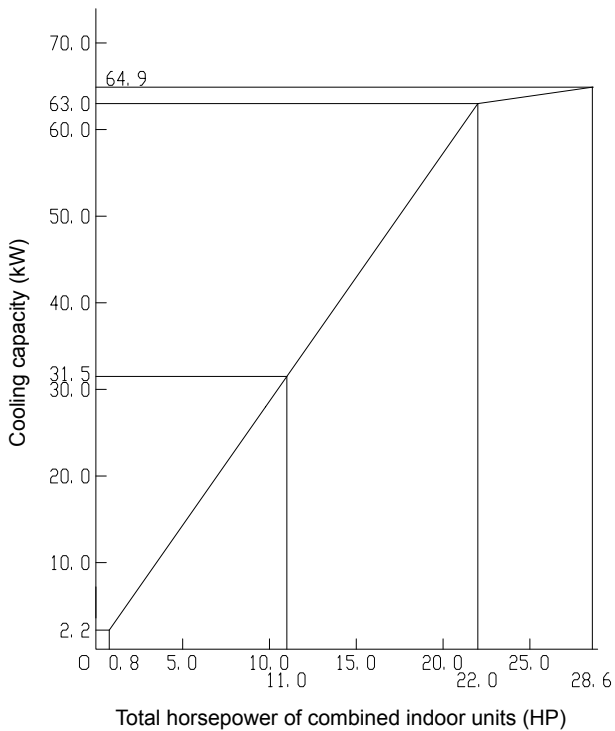

◆ Heating characteristic curve of RAS-22FSN2

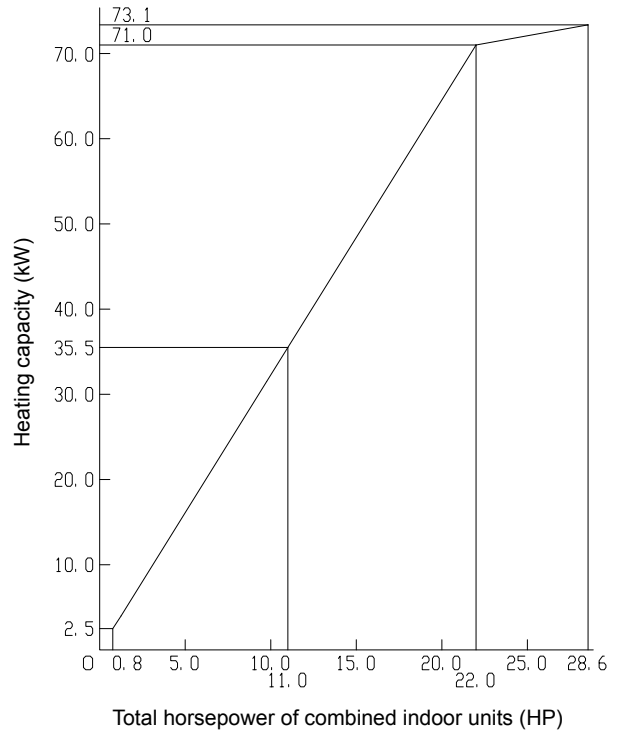

◆ Cooling characteristic curve of RAS-24FSN2

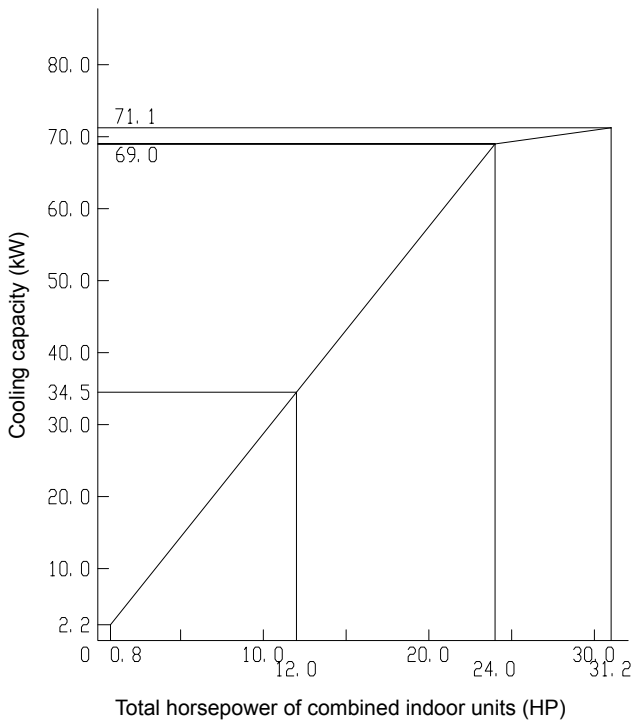

◆ Heating characteristic curve of RAS-24FSN2

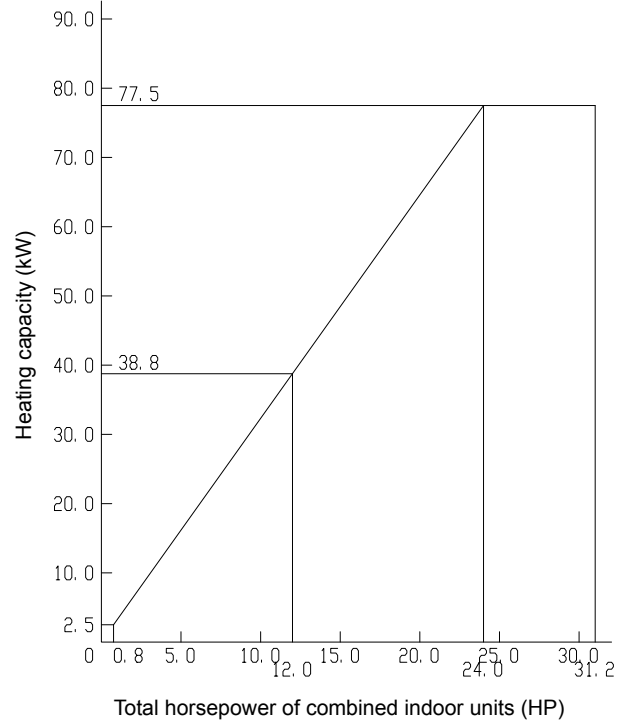

◆ Cooling characteristic curve of RAS-26FSN2

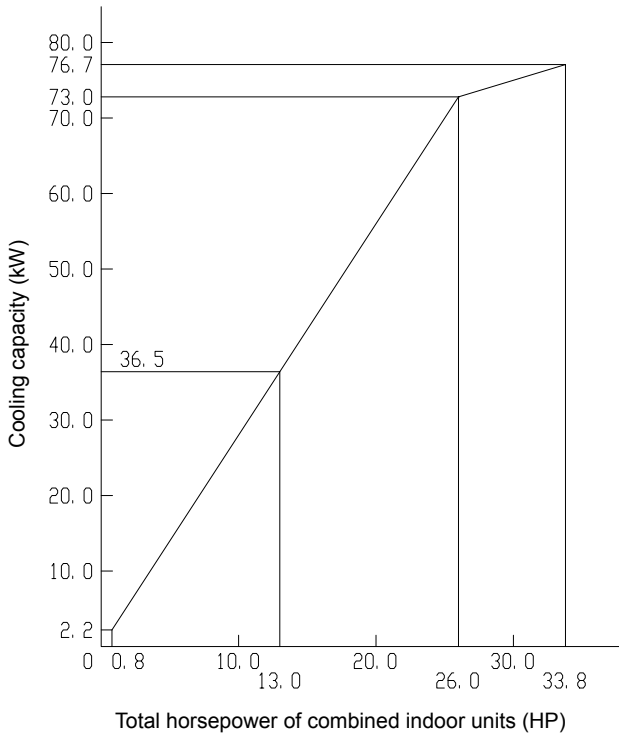

◆ Heating characteristic curve of RAS-26FSN2

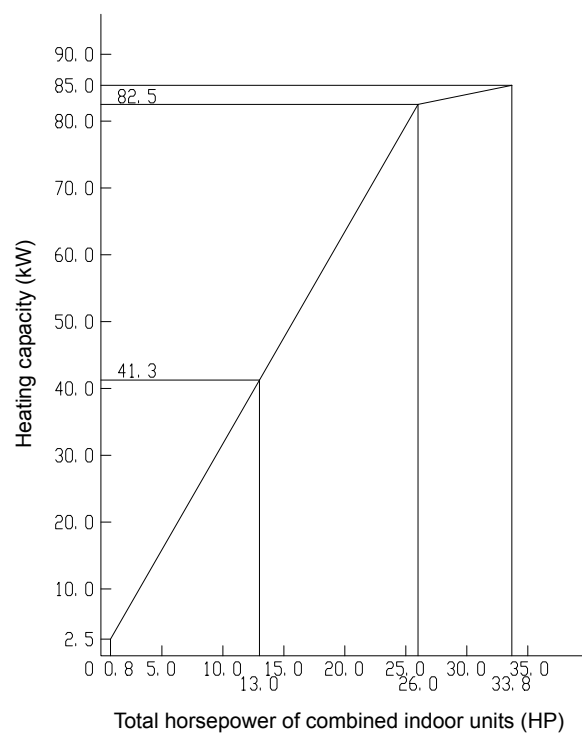

◆ Cooling characteristic curve of RAS-28FSN2

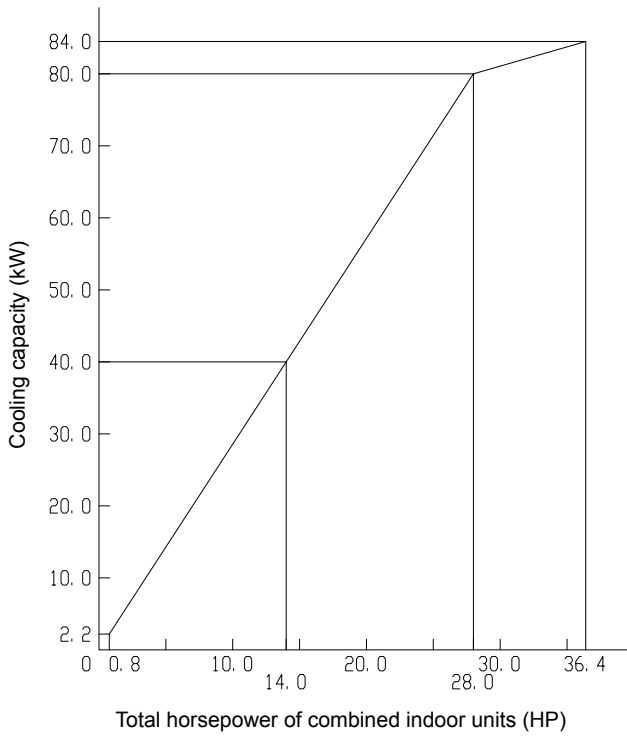

◆ Heating characteristic curve of RAS-28FSN2

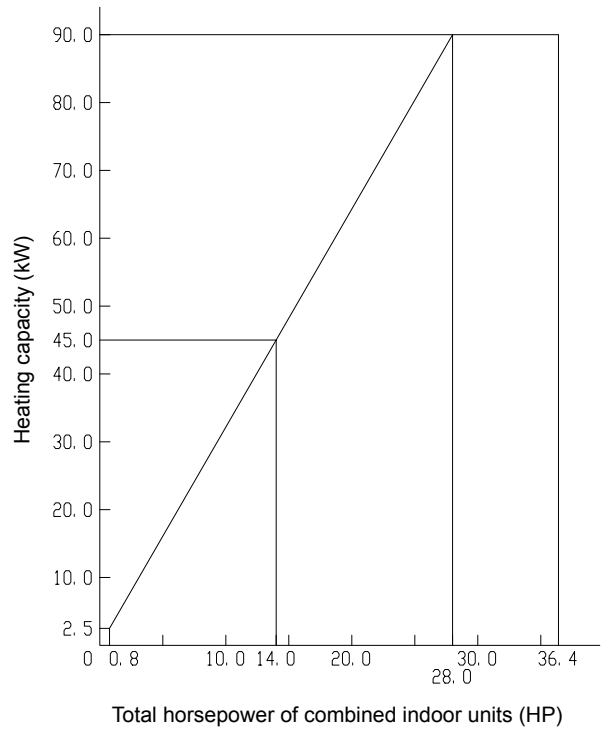

◆ Cooling characteristic curve of RAS-30FSN2

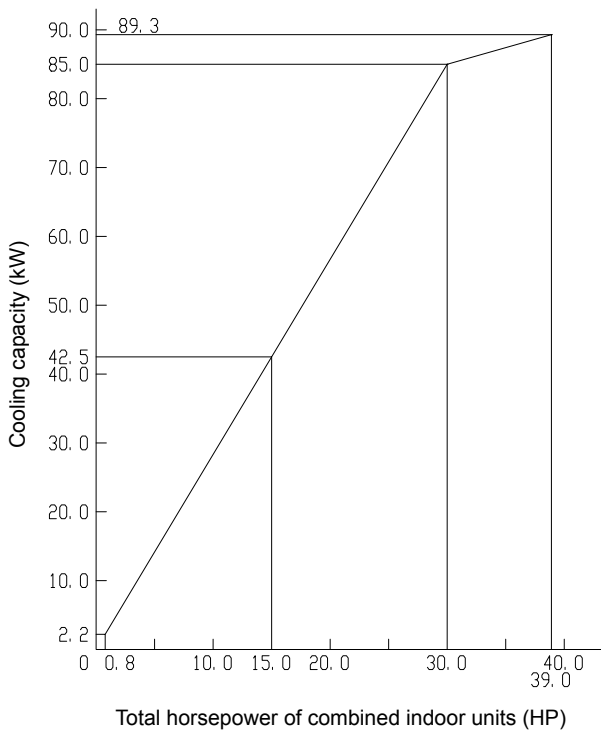

◆ Heating characteristic curve of RAS-30FSN2

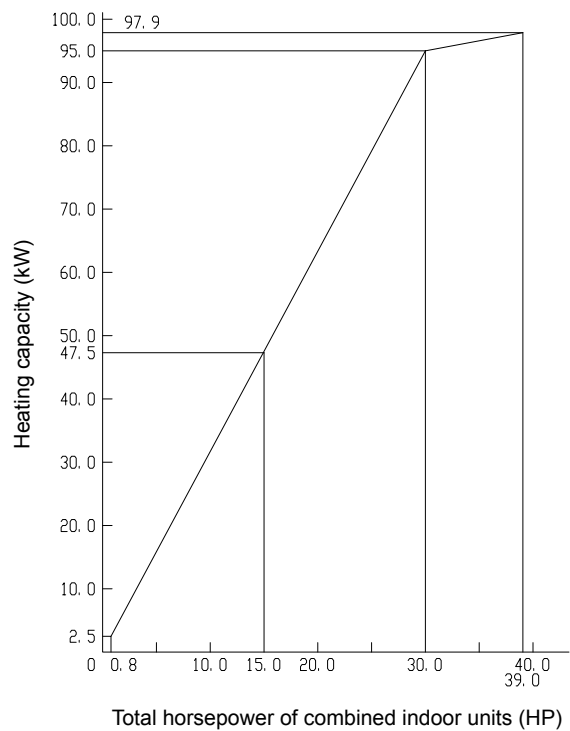

◆ Cooling characteristic curve of RAS-32FSN2

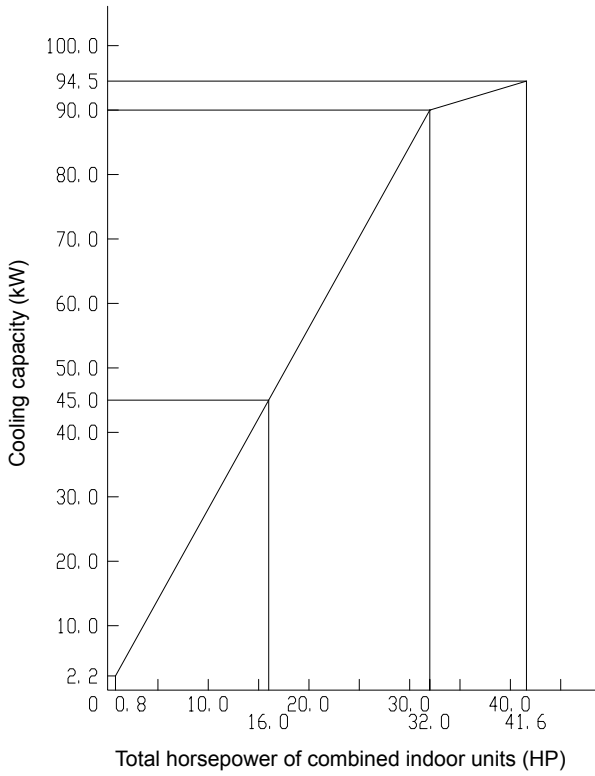

◆ Heating characteristic curve of RAS-32FSN2

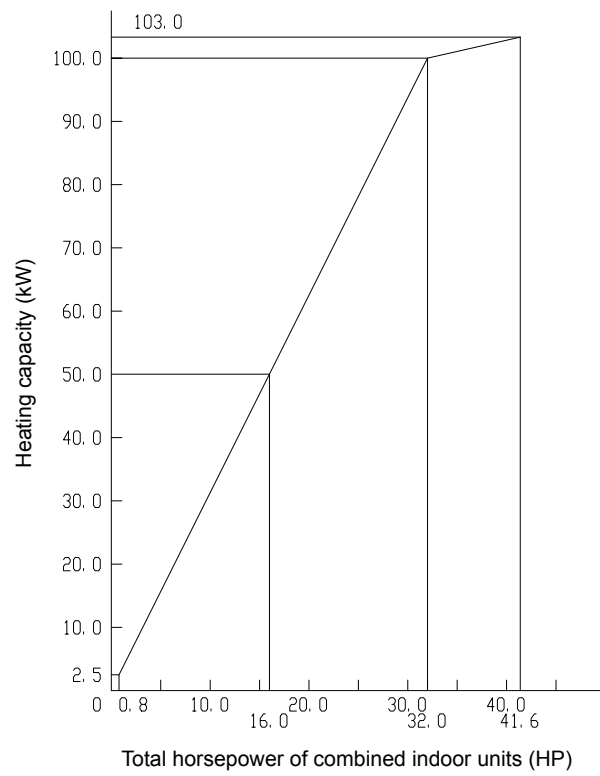

◆ Cooling characteristic curve of RAS-34FSN2

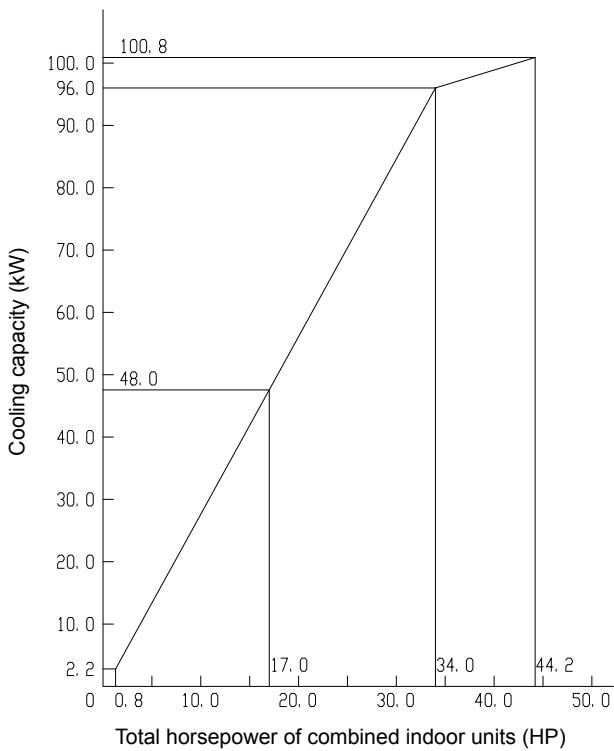

◆ Heating characteristic curve of RAS-34FSN2

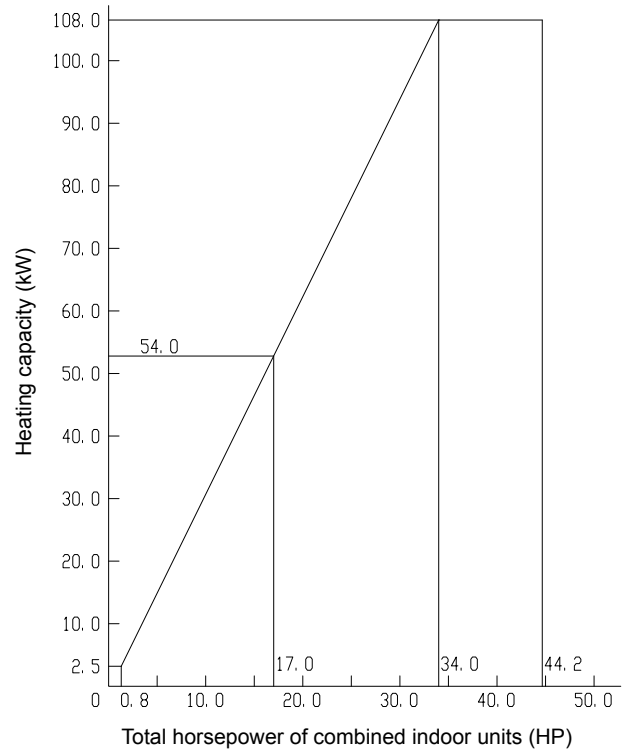

4

◆ Cooling characteristic curve of RAS-36FSN2

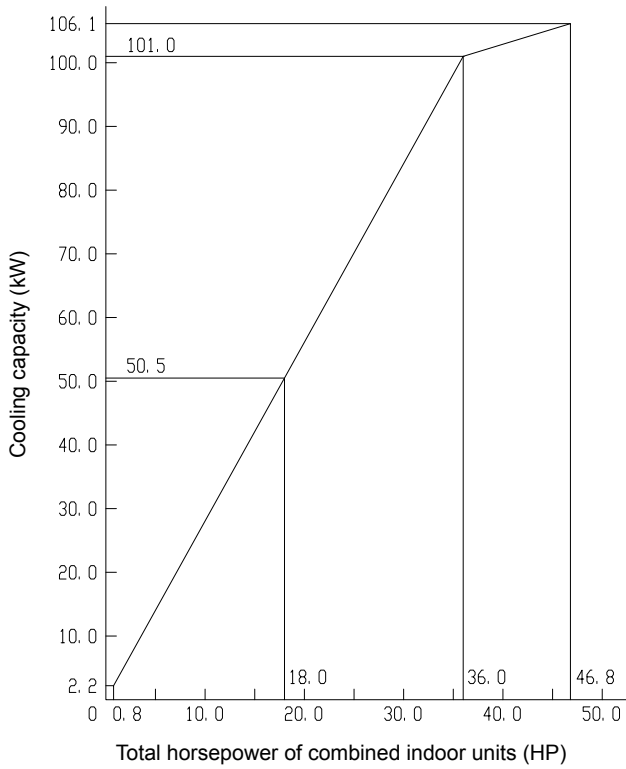

◆ Heating characteristic curve of RAS-36FSN2

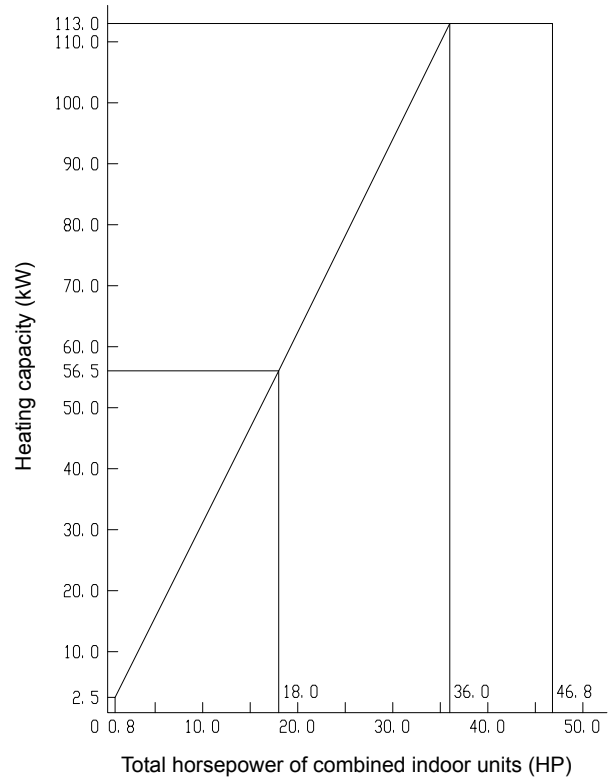

◆ Cooling characteristic curve of RAS-38FSN2

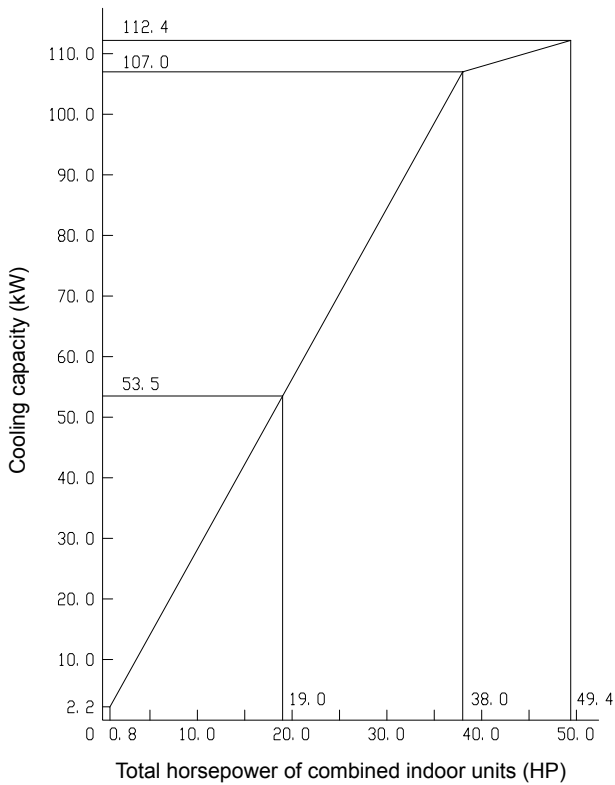

◆ Heating characteristic curve of RAS-38FSN2

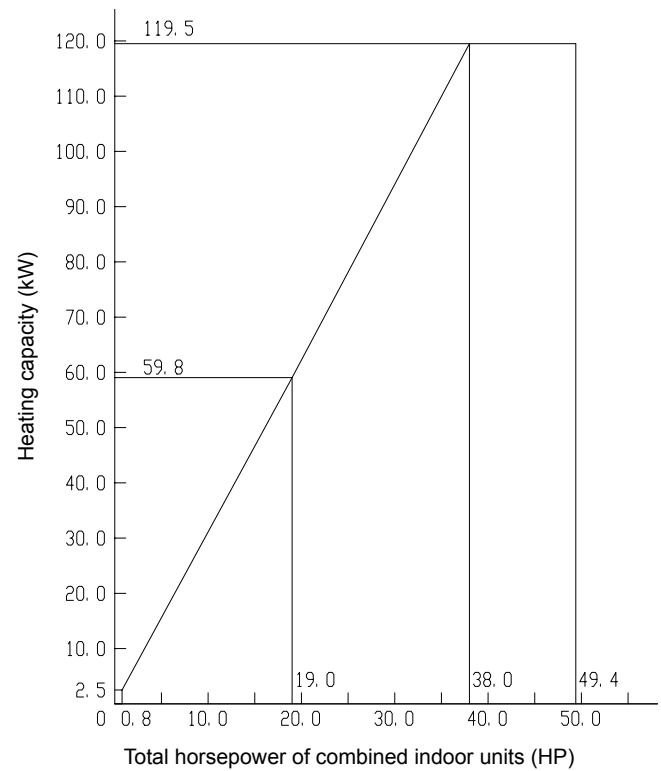

◆ Cooling characteristic curve of RAS-40FSN2

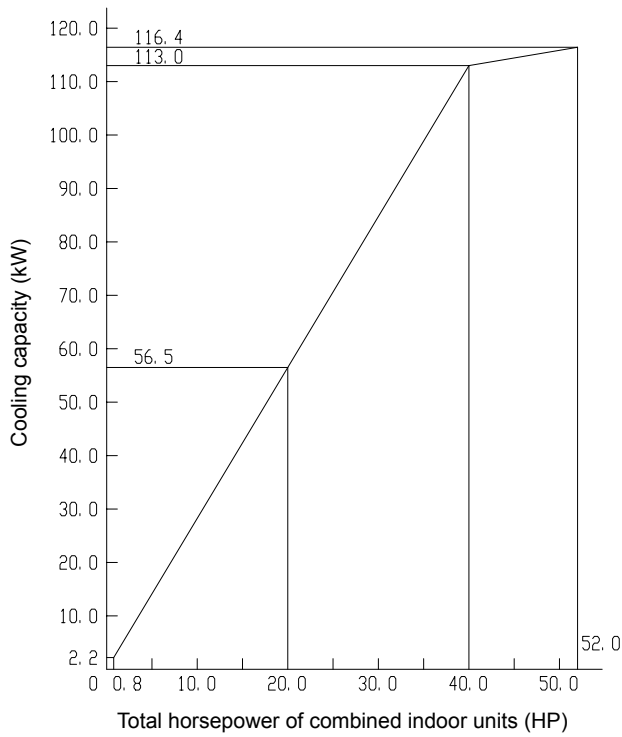

◆ Heating characteristic curve of RAS-40FSN2

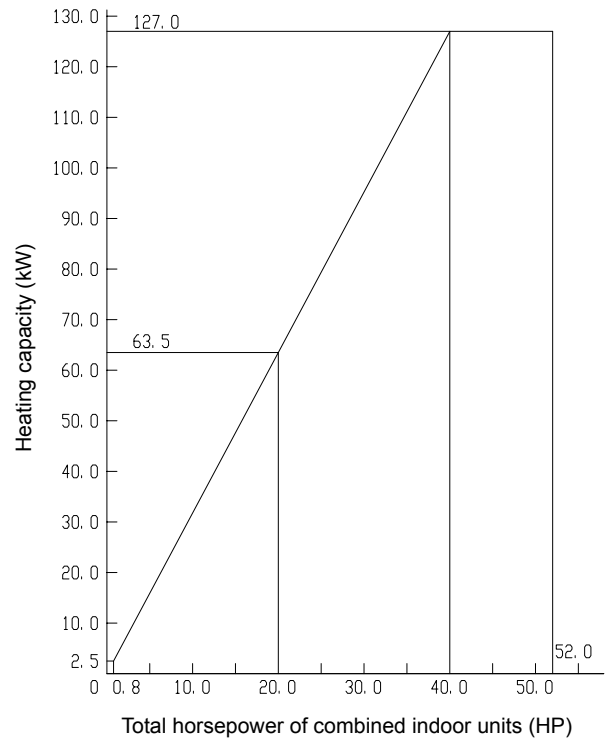

◆ Cooling characteristic curve of RAS-42FSN2

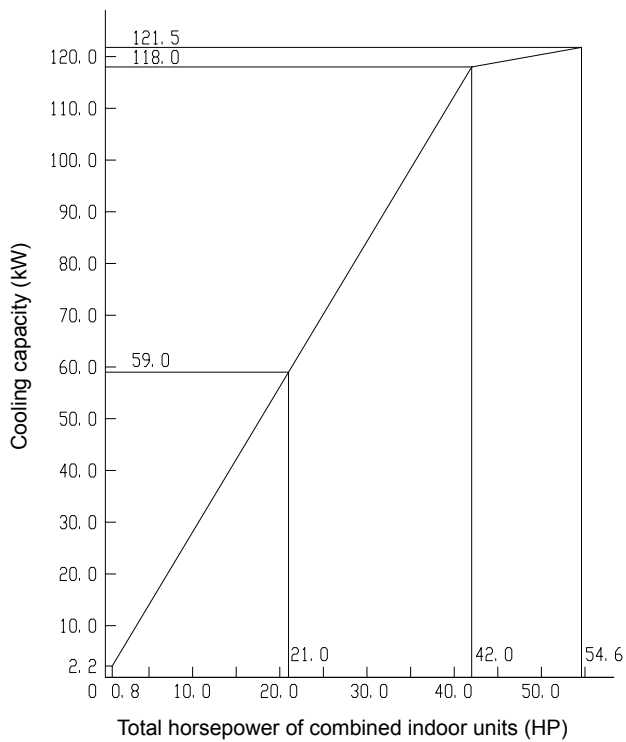

◆ Heating characteristic curve of RAS-42FSN2

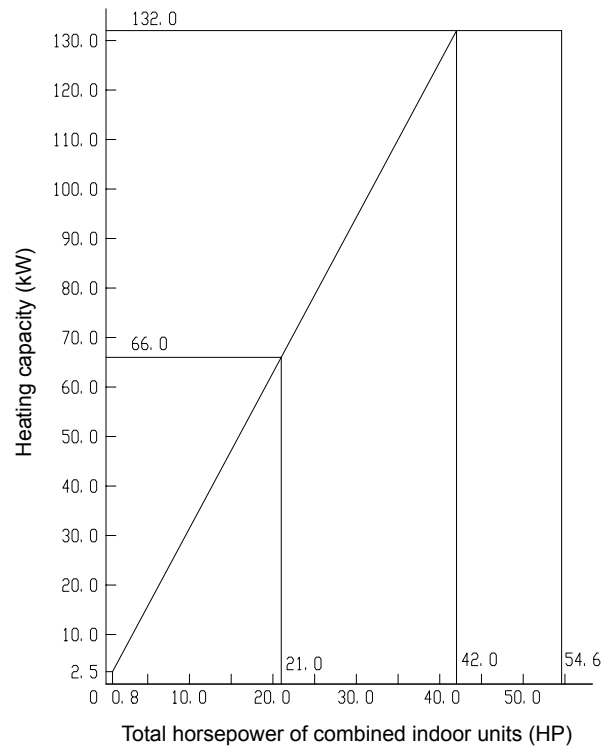

4

◆ Cooling characteristic curve of RAS-44FSN2

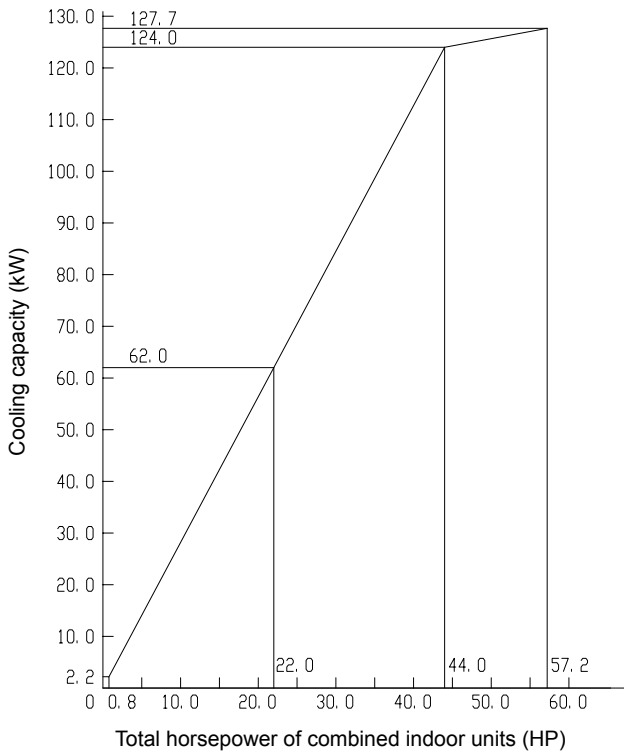

◆ Heating characteristic curve of RAS-44FSN2

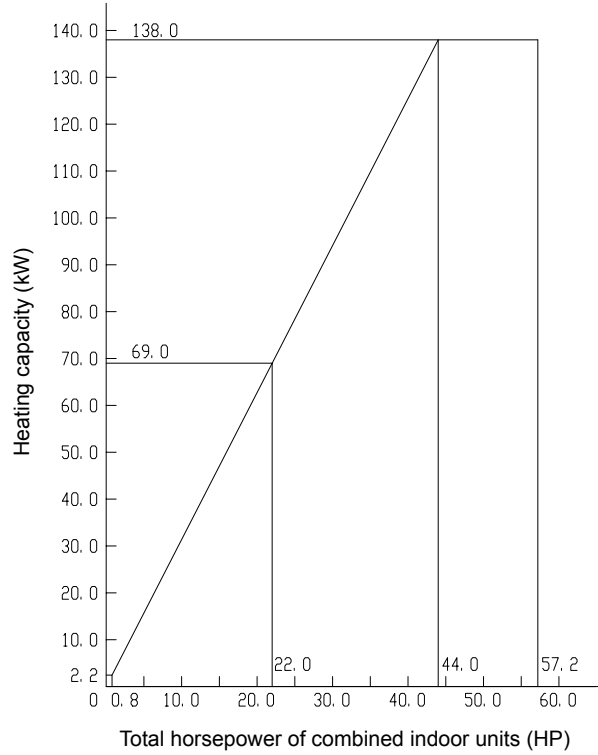

◆ Cooling characteristic curve of RAS-46FSN2

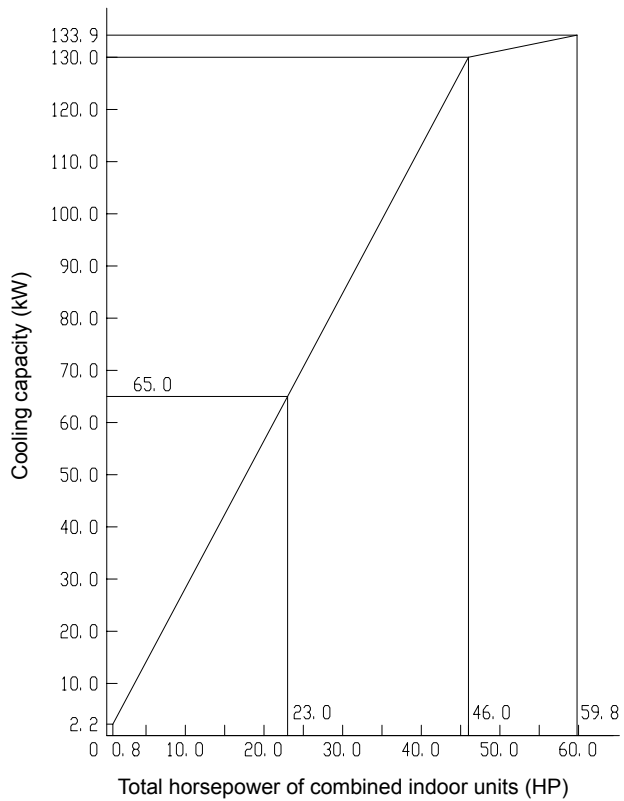

◆ Heating characteristic curve of RAS-46FSN2

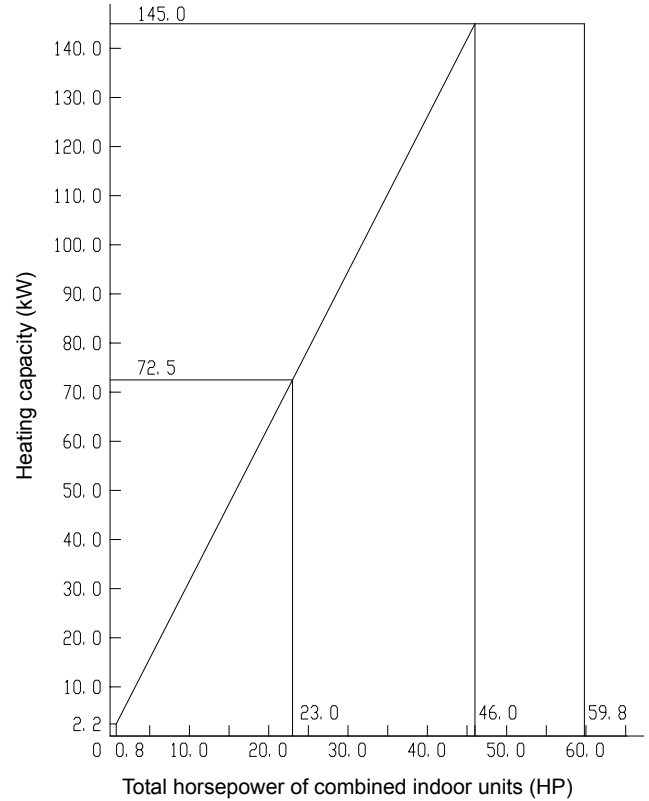

◆ Cooling characteristic curve of RAS-48FSN2

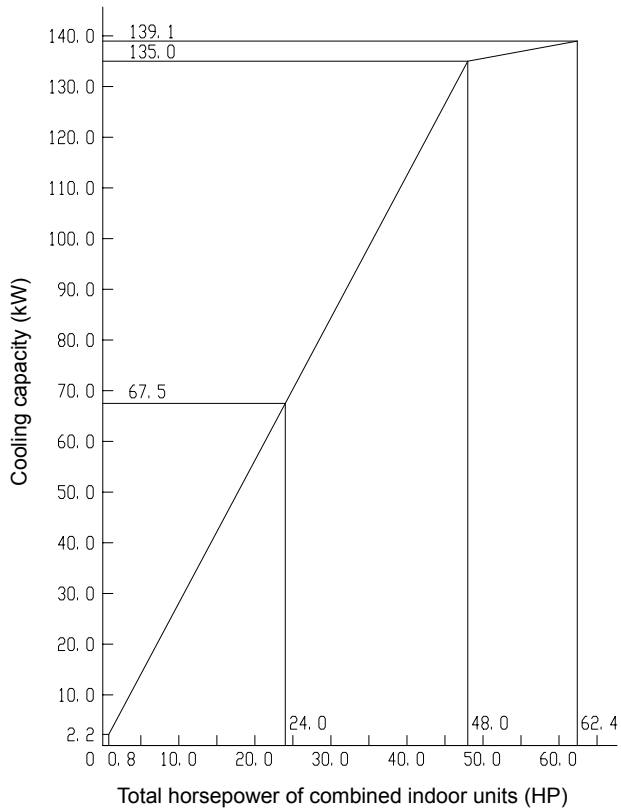

◆ Heating characteristic curve of RAS-48FSN2

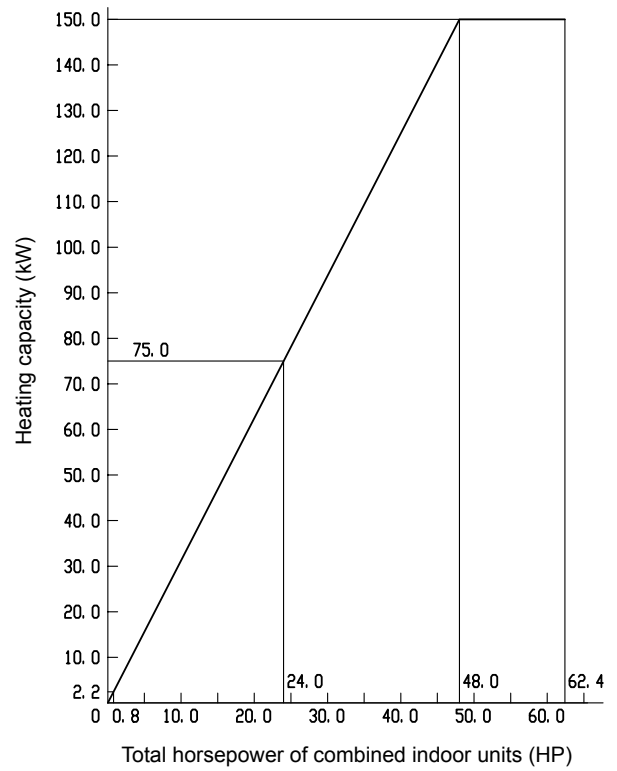

4.4. Nominal cooling capacity tables (100% combination)

Model	CR	Outdoor air inlet temperature (°C DB)	Indoor air inlet temperature WB (°C)/(DB (°C))					
			16/(23)	18/(25)	19/(26)	20/(27)	22/(30)	24/(32)
			CAP Max. (CF)	CAP Max. (CF)	CAP Max. (CF)	CAP Max. (CF)	CAP Max. (CF)	CAP Max. (CF)
RAS-8FSN2	0.70	25	19.0 (0.85)	21.3 (0.95)	22.4 (1.00)	23.3 (1.04)	24.4 (1.09)	25.5 (1.14)
		30	19.0 (0.85)	21.3 (0.95)	22.4 (1.00)	23.3 (1.04)	24.4 (1.09)	25.5 (1.14)
		35	19.0 (0.85)	21.3 (0.95)	22.4 (1.00)	23.3 (1.04)	24.4 (1.09)	25.5 (1.14)
		40	18.5 (0.83)	20.7 (0.92)	21.8 (0.97)	22.7 (1.01)	23.8 (1.06)	24.9 (1.11)
RAS-10FSN2	0.86	25	23.8 (0.85)	26.6 (0.95)	28.0 (1.00)	29.1 (1.04)	30.5 (1.09)	31.9 (1.14)
		30	23.8 (0.85)	26.6 (0.95)	28.0 (1.00)	29.1 (1.04)	30.5 (1.09)	31.9 (1.14)
		35	23.8 (0.85)	26.6 (0.95)	28.0 (1.00)	29.1 (1.04)	30.5 (1.09)	31.9 (1.14)
		40	23.0 (0.82)	25.7 (0.92)	27.0 (0.96)	28.1 (1.00)	29.4 (1.05)	30.8 (1.10)
RAS-12FSN2	1.00	25	28.5 (0.85)	31.8 (0.95)	33.5 (1.00)	34.8 (1.04)	36.5 (1.09)	38.2 (1.14)
		30	28.5 (0.85)	31.8 (0.95)	33.5 (1.00)	34.8 (1.04)	36.5 (1.09)	38.2 (1.14)
		35	28.5 (0.85)	31.8 (0.95)	33.5 (1.00)	34.8 (1.04)	36.5 (1.09)	38.2 (1.14)
		40	27.3 (0.81)	30.5 (0.91)	32.1 (0.96)	33.1 (0.99)	34.3 (1.02)	35.3 (1.05)
RAS-14FSN2	1.25	25	34.0 (0.85)	38.0 (0.95)	40.0 (1.00)	41.6 (1.04)	43.6 (1.09)	45.6 (1.14)
		30	34.0 (0.85)	38.0 (0.95)	40.0 (1.00)	41.6 (1.04)	43.6 (1.09)	45.6 (1.14)
		35	34.0 (0.85)	38.0 (0.95)	40.0 (1.00)	41.6 (1.04)	43.6 (1.09)	45.6 (1.14)
		40	33.3 (0.83)	37.2 (0.93)	39.2 (0.98)	40.8 (1.02)	42.7 (1.07)	44.7 (1.12)
RAS-16FSN2	1.39	25	38.3 (0.85)	42.8 (0.95)	45.0 (1.00)	46.8 (1.04)	49.1 (1.09)	51.3 (1.14)
		30	38.3 (0.85)	42.8 (0.95)	45.0 (1.00)	46.8 (1.04)	49.1 (1.09)	51.3 (1.14)
		35	38.3 (0.85)	42.8 (0.95)	45.0 (1.00)	46.8 (1.04)	49.1 (1.09)	51.3 (1.14)
		40	36.9 (0.82)	41.2 (0.92)	43.4 (0.96)	45.2 (1.00)	47.3 (1.05)	49.5 (1.10)
RAS-18FSN2	1.57	25	42.8 (0.85)	47.9 (0.95)	50.4 (1.00)	52.4 (1.04)	54.9 (1.09)	57.5 (1.14)
		30	42.8 (0.85)	47.9 (0.95)	50.4 (1.00)	52.4 (1.04)	54.9 (1.09)	57.5 (1.14)
		35	42.8 (0.85)	47.9 (0.95)	50.4 (1.00)	52.4 (1.04)	54.9 (1.09)	57.5 (1.14)
		40	41.8 (0.83)	46.7 (0.93)	49.2 (0.98)	51.2 (1.02)	53.6 (1.06)	56.1 (1.11)

4



NOTE:

CAP Max: Compressor capacity at maximum frequency (kW).

CF: Correction factor according to temperature condition.

CR: Correction ratio due to humidity.

Model	CR	Outdoor air inlet temperature (°C DB)	Indoor air inlet temperature WB (°C)/(DB (°C))					
			16/(23)	18/(25)	19/(26)	20/(27)	22/(30)	24/(32)
			CAP Max. (CF)	CAP Max. (CF)	CAP Max. (CF)	CAP Max. (CF)	CAP Max. (CF)	CAP Max. (CF)
RAS-20FSN2	1.74	25	47.6 (0.85)	53.2 (0.95)	56.0 (1.00)	58.2 (1.04)	61.0 (1.09)	63.8 (1.14)
		30	47.6 (0.85)	53.2 (0.95)	56.0 (1.00)	58.2 (1.04)	61.0 (1.09)	63.8 (1.14)
		35	47.6 (0.85)	53.2 (0.95)	56.0 (1.00)	58.2 (1.04)	61.0 (1.09)	63.8 (1.14)
		40	46.2 (0.83)	51.7 (0.92)	54.4 (0.97)	56.6 (1.01)	59.3 (1.06)	62.0 (1.11)
RAS-22FSN2	1.88	25	53.6 (0.85)	59.9 (0.95)	63.0 (1.00)	65.5 (1.04)	68.7 (1.09)	71.8 (1.14)
		30	53.6 (0.85)	59.9 (0.95)	63.0 (1.00)	65.5 (1.04)	68.7 (1.09)	71.8 (1.14)
		35	53.6 (0.85)	59.9 (0.95)	63.0 (1.00)	65.5 (1.04)	68.7 (1.09)	71.8 (1.14)
		40	51.5 (0.82)	57.6 (0.91)	60.6 (0.96)	62.5 (0.99)	64.9 (1.03)	66.7 (1.06)
RAS-24FSN2	2.06	25	58.7 (0.85)	65.6 (0.95)	69.0 (1.00)	71.8 (1.04)	75.2 (1.09)	78.7 (1.14)
		30	58.7 (0.85)	65.6 (0.95)	69.0 (1.00)	71.8 (1.04)	75.2 (1.09)	78.7 (1.14)
		35	58.7 (0.85)	65.6 (0.95)	69.0 (1.00)	71.8 (1.04)	75.2 (1.09)	78.7 (1.14)
		40	55.8 (0.81)	62.4 (0.90)	65.6 (0.95)	67.6 (0.98)	70.2 (1.02)	72.2 (1.05)
RAS-26FSN2	2.26	25	62.1 (0.85)	69.4 (0.95)	73.0 (1.00)	75.9 (1.04)	79.6 (1.09)	83.2 (1.14)
		30	62.1 (0.85)	69.4 (0.95)	73.0 (1.00)	75.9 (1.04)	79.6 (1.09)	83.2 (1.14)
		35	62.1 (0.85)	69.4 (0.95)	73.0 (1.00)	75.9 (1.04)	79.6 (1.09)	83.2 (1.14)
		40	60.2 (0.82)	67.3 (0.92)	70.8 (0.97)	73.6 (1.01)	77.2 (1.06)	80.7 (1.11)
RAS-28FSN2	2.48	25	68.0 (0.85)	76.0 (0.95)	80.0 (1.00)	83.2 (1.04)	87.2 (1.09)	91.2 (1.14)
		30	68.0 (0.85)	76.0 (0.95)	80.0 (1.00)	83.2 (1.04)	87.2 (1.09)	91.2 (1.14)
		35	68.0 (0.85)	76.0 (0.95)	80.0 (1.00)	83.2 (1.04)	87.2 (1.09)	91.2 (1.14)
		40	65.6 (0.82)	73.3 (0.92)	77.2 (0.97)	80.3 (1.00)	84.1 (1.05)	88.0 (1.10)
RAS-30FSN2	2.63	25	72.3 (0.85)	80.8 (0.95)	85.0 (1.00)	88.4 (1.04)	92.7 (1.09)	96.9 (1.14)
		30	72.3 (0.85)	80.8 (0.95)	85.0 (1.00)	88.4 (1.04)	92.7 (1.09)	96.9 (1.14)
		35	72.3 (0.85)	80.8 (0.95)	85.0 (1.00)	88.4 (1.04)	92.7 (1.09)	96.9 (1.14)
		40	69.8 (0.82)	78.0 (0.92)	82.1 (0.97)	85.4 (1.00)	89.5 (1.05)	93.6 (1.10)



NOTE:
CAP Max: Compressor capacity at maximum frequency (kW).
CF: Correction factor according to temperature condition.
CR: Correction ratio due to humidity.

Model	CR	Outdoor air inlet temperature (°C DB)	Indoor air inlet temperature WB (°C)/(DB (°C))					
			16/(23)	18/(25)	19/(26)	20/(27)	22/(30)	24/(32)
			CAP Max. (CF)	CAP Max. (CF)	CAP Max. (CF)	CAP Max. (CF)	CAP Max. (CF)	CAP Max. (CF)
RAS-32FSN2	2.79	25	76.5 (0.85)	85.5 (0.95)	90.0 (1.00)	93.6 (1.04)	98.1 (1.09)	102.6 (1.14)
		30	76.5 (0.85)	85.5 (0.95)	90.0 (1.00)	93.6 (1.04)	98.1 (1.09)	102.6 (1.14)
		35	76.5 (0.85)	85.5 (0.95)	90.0 (1.00)	93.6 (1.04)	98.1 (1.09)	102.6 (1.14)
		40	73.5 (0.82)	82.2 (0.91)	86.5 (0.96)	90.0 (1.00)	94.3 (1.05)	98.6 (1.10)
RAS-34FSN2	2.87	25	81.6 (0.85)	91.2 (0.95)	96.0 (1.00)	99.8 (1.04)	104.6 (1.09)	109.4 (1.14)
		30	81.6 (0.85)	91.2 (0.95)	96.0 (1.00)	99.8 (1.04)	104.6 (1.09)	109.4 (1.14)
		35	81.6 (0.85)	91.2 (0.95)	96.0 (1.00)	99.8 (1.04)	104.6 (1.09)	109.4 (1.14)
		40	78.3 (0.82)	87.5 (0.91)	92.1 (0.96)	94.9 (0.99)	98.6 (1.03)	101.3 (1.06)
RAS-36FSN2	2.96	25	85.9 (0.85)	96.0 (0.95)	101.0 (1.00)	105.0 (1.04)	110.1 (1.09)	115.1 (1.14)
		30	85.9 (0.85)	96.0 (0.95)	101.0 (1.00)	105.0 (1.04)	110.1 (1.09)	115.1 (1.14)
		35	85.9 (0.85)	96.0 (0.95)	101.0 (1.00)	105.0 (1.04)	110.1 (1.09)	115.1 (1.14)
		40	83.0 (0.82)	92.7 (0.92)	97.6 (0.97)	99.6 (0.99)	101.5 (1.00)	105.4 (1.04)
RAS-38FSN2	3.15	25	91.0 (0.85)	101.7 (0.95)	107.0 (1.00)	111.3 (1.04)	116.6 (1.09)	122.0 (1.14)
		30	91.0 (0.85)	101.7 (0.95)	107.0 (1.00)	111.3 (1.04)	116.6 (1.09)	122.0 (1.14)
		35	91.0 (0.85)	101.7 (0.95)	107.0 (1.00)	111.3 (1.04)	116.6 (1.09)	122.0 (1.14)
		40	87.6 (0.82)	97.9 (0.91)	103.1 (0.96)	105.2 (0.98)	107.2 (1.00)	111.3 (1.04)
RAS-40FSN2	3.29	25	96.1 (0.85)	107.4 (0.95)	113.0 (1.00)	117.5 (1.04)	123.2 (1.09)	128.8 (1.14)
		30	96.1 (0.85)	107.4 (0.95)	113.0 (1.00)	117.5 (1.04)	123.2 (1.09)	128.8 (1.14)
		35	96.1 (0.85)	107.4 (0.95)	113.0 (1.00)	117.5 (1.04)	123.2 (1.09)	128.8 (1.14)
		40	89.5 (0.79)	100.1 (0.89)	105.3 (0.93)	107.4 (0.95)	109.5 (0.97)	113.8 (1.01)
RAS-42FSN2	3.44	25	100.3 (0.85)	112.1 (0.95)	118.0 (1.00)	122.7 (1.04)	128.6 (1.09)	134.5 (1.14)
		30	100.3 (0.85)	112.1 (0.95)	118.0 (1.00)	122.7 (1.04)	128.6 (1.09)	134.5 (1.14)
		35	100.3 (0.85)	112.1 (0.95)	118.0 (1.00)	122.7 (1.04)	128.6 (1.09)	134.5 (1.14)
		40	92.0 (0.78)	102.8 (0.87)	108.2 (0.92)	110.4 (0.94)	112.5 (0.95)	116.9 (0.99)

4



NOTE:

CAP Max: Compressor capacity at maximum frequency (kW).
CF: Correction factor according to temperature condition.
CR: Correction ratio due to humidity.

Model	CR	Outdoor air inlet temperature (°C DB)	Indoor air inlet temperature WB (°C)/(DB (°C))					
			16/(23)	18/(25)	19/(26)	20/(27)	22/(30)	24/(32)
			CAP Max. (CF)	CAP Max. (CF)	CAP Max. (CF)	CAP Max. (CF)	CAP Max. (CF)	CAP Max. (CF)
RAS-44FSN2	3.85	25	105.4 (0.85)	117.8 (0.95)	124.0 (1.00)	129.0 (1.04)	135.2 (1.09)	141.4 (1.14)
		30	105.4 (0.85)	117.8 (0.95)	124.0 (1.00)	129.0 (1.04)	135.2 (1.09)	141.4 (1.14)
		35	105.4 (0.85)	117.8 (0.95)	124.0 (1.00)	129.0 (1.04)	135.2 (1.09)	141.4 (1.14)
		40	101.4 (0.82)	113.3 (0.91)	119.3 (0.96)	124.1 (1.00)	130.0 (1.05)	136.0 (1.10)
RAS-46FSN2	3.87	25	110.5 (0.85)	123.5 (0.95)	130.0 (1.00)	135.2 (1.04)	141.7 (1.09)	148.2 (1.14)
		30	110.5 (0.85)	123.5 (0.95)	130.0 (1.00)	135.2 (1.04)	141.7 (1.09)	148.2 (1.14)
		35	110.5 (0.85)	123.5 (0.95)	130.0 (1.00)	135.2 (1.04)	141.7 (1.09)	148.2 (1.14)
		40	105.7 (0.81)	118.2 (0.91)	124.4 (0.96)	128.1 (0.99)	131.9 (1.01)	135.6 (1.04)
RAS-48FSN2	3.95	25	114.8 (0.85)	128.3 (0.95)	135.0 (1.00)	140.4 (1.04)	147.2 (1.09)	153.9 (1.14)
		30	114.8 (0.85)	128.3 (0.95)	135.0 (1.00)	140.4 (1.04)	147.2 (1.09)	153.9 (1.14)
		35	114.8 (0.85)	128.3 (0.95)	135.0 (1.00)	140.4 (1.04)	147.2 (1.09)	153.9 (1.14)
		40	108.6 (0.80)	121.4 (0.90)	127.8 (0.95)	130.4 (0.97)	132.9 (0.98)	138.0 (1.02)



NOTE:

CAP Max: Compressor capacity at maximum frequency (kW)

CF: Correction factor according to temperature condition

CR: Correction ratio due to humidity

4.5. Nominal heating capacity tables (100% combination)

Model	Outdoor air inlet temperature (°C DB)	Indoor air inlet temperature (°C DB)					
		16	18	20	21	22	24
		CAP Max. (CF)	CAP Max. (CF)	CAP Max. (CF)	CAP Max. (CF)	CAP Max. (CF)	CAP Max. (CF)
RAS-8FSN2	-10	22.7 (0.88)	22.7 (0.88)	22.7 (0.88)	22.7 (0.88)	22.6 (0.88)	22.6 (0.88)
	-5	25.2 (0.98)	25.1 (0.97)	25.0 (0.97)	24.9 (0.97)	24.5 (0.95)	22.7 (0.88)
	0	25.1 (0.97)	25.1 (0.97)	25.0 (0.97)	24.9 (0.97)	24.5 (0.95)	22.7 (0.88)
	5	25.3 (0.98)	25.2 (0.98)	25.0 (0.97)	24.9 (0.97)	24.5 (0.95)	22.7 (0.88)
	6	26.8 (1.04)	26.6 (1.03)	25.8 (1.00)	25.3 (0.98)	24.6 (0.95)	22.7 (0.88)
	10	27.5 (1.07)	26.8 (1.04)	25.8 (1.00)	25.3 (0.98)	24.6 (0.95)	22.7 (0.88)
	15	28.4 (1.10)	27.1 (1.05)	25.8 (1.00)	25.3 (0.98)	24.6 (0.95)	22.7 (0.88)
RAS-10FSN2	-10	23.5 (0.75)	23.5 (0.75)	23.5 (0.75)	23.5 (0.75)	23.4 (0.74)	23.4 (0.74)
	-5	27.0 (0.86)	26.9 (0.85)	26.8 (0.85)	26.7 (0.85)	26.7 (0.85)	26.6 (0.84)
	0	29.4 (0.93)	29.4 (0.93)	29.3 (0.93)	29.2 (0.93)	29.0 (0.92)	27.7 (0.88)
	5	31.5 (1.00)	31.4 (1.00)	31.2 (0.99)	30.9 (0.98)	30.1 (0.96)	27.7 (0.88)
	6	32.8 (1.04)	32.4 (1.03)	31.5 (1.00)	30.9 (0.98)	30.1 (0.96)	27.7 (0.88)
	10	34.6 (1.10)	33.8 (1.07)	32.5 (1.03)	31.5 (1.00)	30.1 (0.96)	27.7 (0.88)
	15	35.8 (1.14)	34.1 (1.08)	32.5 (1.03)	31.5 (1.00)	30.1 (0.96)	27.7 (0.88)
RAS-12FSN2	-10	23.8 (0.63)	23.8 (0.63)	23.8 (0.63)	23.8 (0.63)	23.7 (0.63)	23.7 (0.63)
	-5	28.4 (0.76)	28.3 (0.75)	28.2 (0.75)	28.2 (0.75)	28.1 (0.75)	28.0 (0.75)
	0	33.7 (0.90)	33.6 (0.90)	33.5 (0.89)	33.4 (0.89)	33.3 (0.89)	32.4 (0.86)
	5	37.4 (1.00)	37.3 (0.99)	37.0 (0.99)	36.8 (0.98)	35.8 (0.95)	33.0 (0.88)
	6	39.0 (1.04)	38.6 (1.03)	37.5 (1.00)	36.8 (0.98)	35.8 (0.95)	33.0 (0.88)
	10	41.1 (1.10)	40.1 (1.07)	38.6 (1.03)	37.1 (0.99)	35.8 (0.95)	33.0 (0.88)
	15	42.5 (1.13)	40.5 (1.08)	38.6 (1.03)	37.1 (0.99)	35.8 (0.95)	33.0 (0.88)

4



NOTE:

CAP Max: Compressor capacity at maximum frequency (kW)

CF: Correction factor according to temperature condition

Model	Outdoor air inlet temperature (°C DB)	Indoor air inlet temperature (°C DB)					
		16	18	20	21	22	24
		CAP Max. (CF)	CAP Max. (CF)	CAP Max. (CF)	CAP Max. (CF)	CAP Max. (CF)	CAP Max. (CF)
RAS-14FSN2	-10	32.5 (0.72)	32.4 (0.72)	32.4 (0.72)	32.3 (0.72)	32.3 (0.72)	32.3 (0.72)
	-5	37.5 (0.83)	37.3 (0.83)	37.2 (0.83)	37.1 (0.82)	37.1 (0.82)	37.0 (0.82)
	0	42.5 (0.94)	42.5 (0.94)	42.3 (0.94)	42.1 (0.94)	41.5 (0.92)	39.6 (0.88)
	5	45.5 (1.01)	45.4 (1.01)	45.0 (1.00)	44.2 (0.98)	43.0 (0.96)	39.6 (0.88)
	6	46.8 (1.04)	46.4 (1.03)	45.0 (1.00)	44.2 (0.98)	43.0 (0.96)	39.6 (0.88)
	10	49.4 (1.10)	48.3 (1.07)	46.4 (1.03)	44.7 (0.99)	43.0 (0.96)	39.6 (0.88)
	15	51.0 (1.13)	48.7 (1.08)	46.4 (1.03)	44.7 (0.99)	43.0 (0.96)	39.6 (0.88)
RAS-16FSN2	-10	35.4 (0.71)	35.4 (0.71)	35.4 (0.71)	35.3 (0.71)	35.2 (0.70)	35.2 (0.70)
	-5	40.8 (0.82)	40.7 (0.81)	40.5 (0.81)	40.4 (0.81)	40.3 (0.81)	40.3 (0.81)
	0	46.7 (0.93)	46.6 (0.93)	46.4 (0.93)	46.2 (0.92)	45.8 (0.92)	44.0 (0.88)
	5	50.5 (1.01)	50.4 (1.01)	50.0 (1.00)	49.0 (0.98)	47.8 (0.96)	44.0 (0.88)
	6	52.0 (1.04)	51.5 (1.03)	50.0 (1.00)	49.0 (0.98)	47.8 (0.96)	44.0 (0.88)
	10	54.8 (1.10)	53.6 (1.07)	51.5 (1.03)	49.7 (0.99)	47.8 (0.96)	44.0 (0.88)
	15	56.7 (1.13)	54.1 (1.08)	51.5 (1.03)	49.7 (0.99)	47.8 (0.96)	44.0 (0.88)
RAS-18FSN2	-10	39.5 (0.71)	39.5 (0.71)	39.5 (0.71)	39.4 (0.70)	39.3 (0.70)	39.3 (0.70)
	-5	46.0 (0.82)	45.9 (0.82)	45.7 (0.82)	45.6 (0.81)	45.5 (0.81)	45.4 (0.81)
	0	50.7 (0.91)	50.6 (0.90)	50.4 (0.90)	50.2 (0.90)	49.8 (0.89)	48.7 (0.87)
	5	55.1 (0.98)	55.0 (0.98)	54.6 (0.98)	54.1 (0.97)	53.5 (0.96)	49.3 (0.88)
	6	58.2 (1.04)	57.7 (1.03)	56.0 (1.00)	54.9 (0.98)	53.5 (0.96)	49.3 (0.88)
	10	61.5 (1.10)	60.0 (1.07)	57.7 (1.03)	55.4 (0.99)	53.5 (0.96)	49.3 (0.88)
	15	63.5 (1.13)	60.6 (1.08)	57.7 (1.03)	55.4 (0.99)	53.5 (0.96)	49.3 (0.88)



NOTE:
CAP Max: Compressor capacity at maximum frequency (kW)
CF: Correction factor according to temperature condition

Model	Outdoor air inlet temperature (°C DB)	Indoor air inlet temperature (°C DB)					
		16	18	20	21	22	24
		CAP Max. (CF)	CAP Max. (CF)	CAP Max. (CF)	CAP Max. (CF)	CAP Max. (CF)	CAP Max. (CF)
RAS-20FSN2	-10	44.6 (0.71)	44.6 (0.71)	44.6 (0.71)	44.5 (0.71)	44.4 (0.70)	44.4 (0.70)
	-5	51.9 (0.82)	51.7 (0.82)	51.5 (0.82)	51.4 (0.82)	51.3 (0.81)	51.2 (0.81)
	0	57.1 (0.91)	57.0 (0.90)	56.8 (0.90)	56.6 (0.90)	56.2 (0.89)	54.9 (0.87)
	5	62.1 (0.99)	62.0 (0.98)	61.5 (0.98)	61.0 (0.97)	60.2 (0.96)	55.4 (0.88)
	6	65.5 (1.04)	64.9 (1.03)	63.0 (1.00)	61.7 (0.98)	60.2 (0.96)	55.4 (0.88)
	10	69.1 (1.10)	67.5 (1.07)	64.9 (1.03)	62.4 (0.99)	60.2 (0.96)	55.4 (0.88)
	15	71.4 (1.13)	68.1 (1.08)	64.9 (1.03)	62.4 (0.99)	60.2 (0.96)	55.4 (0.88)
RAS-22FSN2	-10	51.4 (0.72)	51.3 (0.72)	51.3 (0.72)	51.2 (0.72)	51.1 (0.72)	51.1 (0.72)
	-5	58.9 (0.83)	58.7 (0.83)	58.5 (0.82)	58.4 (0.82)	58.2 (0.82)	58.1 (0.82)
	0	64.7 (0.91)	64.6 (0.91)	64.4 (0.91)	64.1 (0.90)	63.9 (0.90)	62.2 (0.88)
	5	69.9 (0.98)	69.8 (0.98)	69.2 (0.97)	68.5 (0.96)	67.8 (0.95)	62.5 (0.88)
	6	73.8 (1.04)	73.1 (1.03)	71.0 (1.00)	69.6 (0.98)	67.8 (0.95)	62.5 (0.88)
	10	78.0 (1.10)	76.1 (1.07)	73.2 (1.03)	70.5 (0.99)	67.8 (0.95)	62.5 (0.88)
	15	80.5 (1.13)	76.9 (1.08)	73.2 (1.03)	70.5 (0.99)	67.8 (0.95)	62.5 (0.88)
RAS-24FSN2	-10	56.1 (0.72)	56.0 (0.72)	56.0 (0.72)	55.9 (0.72)	55.8 (0.72)	55.8 (0.72)
	-5	64.3 (0.83)	64.1 (0.83)	63.8 (0.82)	63.7 (0.82)	63.6 (0.82)	63.4 (0.82)
	0	68.1 (0.88)	68.0 (0.88)	67.8 (0.87)	67.5 (0.87)	67.3 (0.87)	65.5 (0.85)
	5	76.4 (0.99)	76.2 (0.98)	75.6 (0.98)	75.2 (0.97)	74.0 (0.95)	68.2 (0.88)
	6	80.6 (1.04)	79.8 (1.03)	77.5 (1.00)	76.1 (0.98)	74.0 (0.95)	68.2 (0.88)
	10	85.1 (1.10)	83.1 (1.07)	79.9 (1.03)	76.7 (0.99)	74.0 (0.95)	68.2 (0.88)
	15	87.9 (1.13)	83.9 (1.08)	79.9 (1.03)	76.7 (0.99)	74.0 (0.95)	68.2 (0.88)

4



NOTE:

CAP Max: Compressor capacity at maximum frequency (kW)
CF: Correction factor according to temperature condition

Model	Outdoor air inlet temperature (°C DB)	Indoor air inlet temperature (°C DB)					
		16	18	20	21	22	24
		CAP Max. (CF)	CAP Max. (CF)	CAP Max. (CF)	CAP Max. (CF)	CAP Max. (CF)	CAP Max. (CF)
RAS-26FSN2	-10	60.3 (0.73)	60.3 (0.73)	60.2 (0.73)	60.1 (0.73)	60.0 (0.73)	60.0 (0.73)
	-5	68.5 (0.83)	68.2 (0.83)	67.9 (0.82)	67.8 (0.82)	67.7 (0.82)	67.5 (0.82)
	0	78.3 (0.95)	78.2 (0.95)	77.9 (0.94)	77.6 (0.94)	77.0 (0.93)	72.6 (0.88)
	5	83.3 (1.01)	83.2 (1.01)	82.5 (1.00)	80.9 (0.98)	78.8 (0.96)	72.6 (0.88)
	6	85.8 (1.04)	85.0 (1.03)	82.5 (1.00)	80.9 (0.98)	78.8 (0.96)	72.6 (0.88)
	10	90.5 (1.10)	88.4 (1.07)	85.0 (1.03)	81.7 (0.99)	78.8 (0.96)	72.6 (0.88)
	15	93.5 (1.13)	89.3 (1.08)	85.0 (1.03)	81.7 (0.99)	78.8 (0.96)	72.6 (0.88)
RAS-28FSN2	-10	65.8 (0.73)	65.7 (0.73)	65.6 (0.73)	65.5 (0.73)	65.4 (0.73)	65.4 (0.73)
	-5	74.7 (0.83)	74.4 (0.83)	74.1 (0.82)	73.9 (0.82)	73.8 (0.82)	73.6 (0.82)
	0	81.9 (0.91)	81.8 (0.91)	81.5 (0.91)	81.2 (0.90)	80.8 (0.90)	78.7 (0.87)
	5	88.7 (0.99)	88.5 (0.98)	87.8 (0.98)	87.2 (0.97)	86.0 (0.96)	79.2 (0.88)
	6	93.6 (1.04)	92.7 (1.03)	90.0 (1.00)	88.2 (0.98)	86.0 (0.96)	79.2 (0.88)
	10	98.7 (1.10)	96.4 (1.07)	92.7 (1.03)	89.5 (0.99)	86.0 (0.96)	79.2 (0.88)
	15	102.0 (1.13)	97.3 (1.08)	92.7 (1.03)	89.5 (0.99)	86.0 (0.96)	79.2 (0.88)
RAS-30FSN2	-10	69.8 (0.73)	69.7 (0.73)	69.6 (0.73)	69.5 (0.73)	69.4 (0.73)	69.4 (0.73)
	-5	78.8 (0.83)	78.5 (0.83)	78.2 (0.82)	78.0 (0.82)	77.9 (0.82)	77.7 (0.82)
	0	85.2 (0.90)	85.2 (0.90)	84.8 (0.89)	84.5 (0.89)	83.9 (0.88)	81.9 (0.86)
	5	96.0 (1.01)	95.8 (1.01)	95.0 (1.00)	93.3 (0.98)	91.0 (0.96)	83.6 (0.88)
	6	98.8 (1.04)	97.9 (1.03)	95.0 (1.00)	93.3 (0.98)	91.0 (0.96)	83.6 (0.88)
	10	104.3 (1.10)	101.8 (1.07)	97.9 (1.03)	94.5 (0.99)	91.0 (0.96)	83.6 (0.88)
	15	107.7 (1.13)	102.8 (1.08)	97.9 (1.03)	94.5 (0.99)	91.0 (0.96)	83.6 (0.88)



NOTE:

CAP Max: Compressor capacity at maximum frequency (kW)
CF: Correction factor according to temperature condition

Model	Outdoor air inlet temperature (°C DB)	Indoor air inlet temperature (°C DB)					
		16	18	20	21	22	24
		CAP Max. (CF)	CAP Max. (CF)	CAP Max. (CF)	CAP Max. (CF)	CAP Max. (CF)	CAP Max. (CF)
RAS-32FSN2	-10	73.4 (0.73)	73.3 (0.73)	73.2 (0.73)	73.1 (0.73)	73.0 (0.73)	72.9 (0.73)
	-5	83.1 (0.83)	82.7 (0.83)	82.4 (0.82)	82.2 (0.82)	82.1 (0.82)	81.9 (0.82)
	0	87.8 (0.88)	87.8 (0.88)	87.4 (0.87)	87.1 (0.87)	86.4 (0.86)	84.4 (0.84)
	5	98.6 (0.99)	98.4 (0.98)	97.6 (0.98)	97.0 (0.97)	95.5 (0.96)	88.0 (0.88)
	6	104.0 (1.04)	103.0 (1.03)	100.0 (1.00)	98.0 (0.98)	95.5 (0.96)	88.0 (0.88)
	10	109.7 (1.10)	107.1 (1.07)	103.0 (1.03)	99.5 (1.00)	95.5 (0.96)	88.0 (0.88)
	15	113.3 (1.13)	108.2 (1.08)	103.0 (1.03)	99.5 (1.00)	95.5 (0.96)	88.0 (0.88)
RAS-34FSN2	-10	80.2 (0.74)	80.1 (0.74)	80.0 (0.74)	79.9 (0.74)	79.8 (0.74)	79.7 (0.74)
	-5	89.7 (0.83)	89.4 (0.83)	89.0 (0.82)	88.8 (0.82)	88.6 (0.82)	88.5 (0.82)
	0	100.2 (0.93)	100.1 (0.93)	99.7 (0.92)	99.3 (0.92)	98.5 (0.91)	95.0 (0.88)
	5	106.5 (0.99)	106.2 (0.98)	105.4 (0.98)	104.9 (0.97)	103.1 (0.95)	95.0 (0.88)
	6	112.3 (1.04)	111.2 (1.03)	108.0 (1.00)	105.8 (0.98)	103.1 (0.95)	95.0 (0.88)
	10	118.4 (1.10)	115.6 (1.07)	111.2 (1.03)	106.9 (0.99)	103.1 (0.95)	95.0 (0.88)
	15	122.3 (1.13)	116.8 (1.08)	111.2 (1.03)	106.9 (0.99)	103.1 (0.95)	95.0 (0.88)
RAS-36FSN2	-10	83.7 (0.74)	83.6 (0.74)	83.5 (0.74)	83.3 (0.74)	83.3 (0.74)	83.2 (0.74)
	-5	93.9 (0.83)	93.5 (0.83)	93.1 (0.82)	92.9 (0.82)	92.7 (0.82)	92.6 (0.82)
	0	102.1 (0.90)	102.0 (0.90)	101.6 (0.90)	101.2 (0.90)	100.7 (0.89)	98.1 (0.87)
	5	111.3 (0.98)	111.1 (0.98)	110.2 (0.98)	109.8 (0.97)	107.9 (0.95)	99.4 (0.88)
	6	117.5 (1.04)	116.4 (1.03)	113.0 (1.00)	110.7 (0.98)	107.9 (0.95)	99.4 (0.88)
	10	124.0 (1.10)	121.1 (1.07)	116.4 (1.03)	111.9 (0.99)	107.9 (0.95)	99.4 (0.88)
	15	128.0 (1.13)	122.2 (1.08)	116.4 (1.03)	111.9 (0.99)	107.9 (0.95)	99.4 (0.88)

4



NOTE:

CAP Max: Compressor capacity at maximum frequency (kW)
CF: Correction factor according to temperature condition

Model	Outdoor air inlet temperature (°C DB)	Indoor air inlet temperature (°C DB)					
		16	18	20	21	22	24
		CAP Max. (CF)	CAP Max. (CF)	CAP Max. (CF)	CAP Max. (CF)	CAP Max. (CF)	CAP Max. (CF)
RAS-38FSN2	-10	87.2 (0.73)	87.1 (0.73)	87.0 (0.73)	86.8 (0.73)	86.7 (0.73)	86.6 (0.72)
	-5	99.3 (0.83)	98.9 (0.83)	98.5 (0.82)	98.3 (0.82)	98.1 (0.82)	97.9 (0.82)
	0	107.6 (0.90)	107.5 (0.90)	107.1 (0.90)	106.7 (0.89)	105.8 (0.89)	103.4 (0.87)
	5	117.7 (0.98)	117.4 (0.98)	116.5 (0.97)	115.8 (0.97)	114.1 (0.95)	105.2 (0.88)
	6	124.3 (1.04)	123.1 (1.03)	119.5 (1.00)	117.1 (0.98)	114.1 (0.95)	105.2 (0.88)
	10	131.1 (1.10)	128.0 (1.07)	123.1 (1.03)	119.0 (1.00)	114.1 (0.95)	105.2 (0.88)
	15	135.4 (1.13)	129.3 (1.08)	123.1 (1.03)	119.0 (1.00)	114.1 (0.95)	105.2 (0.88)
RAS-40FSN2	-10	92.7 (0.73)	92.6 (0.73)	92.5 (0.73)	92.4 (0.73)	92.3 (0.73)	92.2 (0.73)
	-5	105.4 (0.83)	105.0 (0.83)	104.6 (0.82)	104.4 (0.82)	104.2 (0.82)	104.0 (0.82)
	0	114.4 (0.90)	114.2 (0.90)	113.8 (0.90)	113.3 (0.89)	112.5 (0.89)	109.9 (0.87)
	5	128.3 (1.01)	128.0 (1.01)	127.0 (1.00)	124.7 (0.98)	121.3 (0.96)	111.8 (0.88)
	6	132.1 (1.04)	130.8 (1.03)	127.0 (1.00)	124.7 (0.98)	121.3 (0.96)	111.8 (0.88)
	10	139.4 (1.10)	136.1 (1.07)	130.9 (1.03)	126.4 (1.00)	121.3 (0.96)	111.8 (0.88)
	15	144.0 (1.13)	137.4 (1.08)	130.9 (1.03)	126.4 (1.00)	121.3 (0.96)	111.8 (0.88)
RAS-42FSN2	-10	96.3 (0.73)	96.2 (0.73)	96.1 (0.73)	95.9 (0.73)	95.8 (0.73)	95.7 (0.73)
	-5	109.5 (0.83)	109.1 (0.83)	108.6 (0.82)	108.4 (0.82)	108.2 (0.82)	108.0 (0.82)
	0	118.9 (0.90)	118.7 (0.90)	118.3 (0.90)	117.8 (0.89)	117.0 (0.89)	114.3 (0.87)
	5	130.0 (0.98)	129.7 (0.98)	128.7 (0.97)	128.0 (0.97)	126.1 (0.96)	116.2 (0.88)
	6	137.3 (1.04)	136.0 (1.03)	132.0 (1.00)	129.4 (0.98)	126.1 (0.96)	116.2 (0.88)
	10	144.8 (1.10)	141.4 (1.07)	136.0 (1.03)	131.0 (0.99)	126.1 (0.96)	116.2 (0.88)
	15	149.6 (1.13)	142.8 (1.08)	136.0 (1.03)	131.0 (0.99)	126.1 (0.96)	116.2 (0.88)



NOTE:

CAP Max: Compressor capacity at maximum frequency (kW)
CF: Correction factor according to temperature condition

Model	Outdoor air inlet temperature (°C DB)	Indoor air inlet temperature (°C DB)					
		16	18	20	21	22	24
		CAP Max. (CF)	CAP Max. (CF)	CAP Max. (CF)	CAP Max. (CF)	CAP Max. (CF)	CAP Max. (CF)
RAS-44FSN2	-10	100.6 (0.73)	100.5 (0.73)	100.4 (0.73)	100.2 (0.73)	100.1 (0.73)	100.0 (0.72)
	-5	114.5 (0.83)	114.1 (0.83)	113.6 (0.82)	113.4 (0.82)	113.1 (0.82)	112.9 (0.82)
	0	122.7 (0.89)	122.6 (0.89)	122.1 (0.88)	121.6 (0.88)	120.2 (0.87)	117.9 (0.85)
	5	135.9 (0.98)	135.7 (0.98)	134.6 (0.98)	133.9 (0.97)	131.8 (0.96)	121.4 (0.88)
	6	143.5 (1.04)	142.1 (1.03)	138.0 (1.00)	135.2 (0.98)	131.8 (0.96)	121.4 (0.88)
	10	151.4 (1.10)	147.9 (1.07)	142.2 (1.03)	137.2 (0.99)	131.8 (0.96)	121.4 (0.88)
	15	156.4 (1.13)	149.3 (1.08)	142.2 (1.03)	137.2 (0.99)	131.8 (0.96)	121.4 (0.88)
RAS-46FSN2	-10	102.0 (0.70)	101.9 (0.70)	101.8 (0.70)	101.6 (0.70)	101.5 (0.70)	101.4 (0.70)
	-5	116.6 (0.80)	116.2 (0.80)	115.7 (0.80)	115.5 (0.80)	115.2 (0.79)	115.0 (0.79)
	0	126.8 (0.87)	126.7 (0.87)	126.2 (0.87)	125.7 (0.87)	125.0 (0.86)	121.9 (0.84)
	5	142.8 (0.98)	142.5 (0.98)	141.4 (0.98)	140.8 (0.97)	138.5 (0.96)	127.6 (0.88)
	6	150.8 (1.04)	149.4 (1.03)	145.0 (1.00)	142.1 (0.98)	138.5 (0.96)	127.6 (0.88)
	10	159.1 (1.10)	155.4 (1.07)	149.4 (1.03)	144.2 (0.99)	138.5 (0.96)	127.6 (0.88)
	15	164.3 (1.13)	156.9 (1.08)	149.4 (1.03)	144.2 (0.99)	138.5 (0.96)	127.6 (0.88)
RAS-48FSN2	-10	104.5 (0.70)	104.4 (0.70)	104.3 (0.70)	104.1 (0.69)	104.0 (0.69)	103.9 (0.69)
	-5	119.4 (0.80)	119.0 (0.79)	118.5 (0.79)	118.3 (0.79)	118.0 (0.79)	117.8 (0.79)
	0	129.5 (0.86)	129.4 (0.86)	128.8 (0.86)	128.3 (0.86)	127.7 (0.85)	124.5 (0.83)
	5	147.7 (0.98)	147.4 (0.98)	146.2 (0.97)	145.5 (0.97)	143.3 (0.96)	132.0 (0.88)
	6	156.0 (1.04)	154.5 (1.03)	150.0 (1.00)	147.0 (0.98)	143.3 (0.96)	132.0 (0.88)
	10	164.6 (1.10)	160.8 (1.07)	154.6 (1.03)	149.5 (1.00)	143.3 (0.96)	132.0 (0.88)
	15	170.1 (1.13)	162.3 (1.08)	154.6 (1.03)	149.5 (1.00)	143.3 (0.96)	132.0 (0.88)

4



NOTE:
CAP Max: Compressor capacity at maximum frequency (kW)
CF: Correction factor according to temperature condition

4.6. Correction factors

4.6.1. Piping length correction factor

The correction factor is based on the equivalent piping length in meters (EL) and the height between outdoor and indoor units in meters (H).

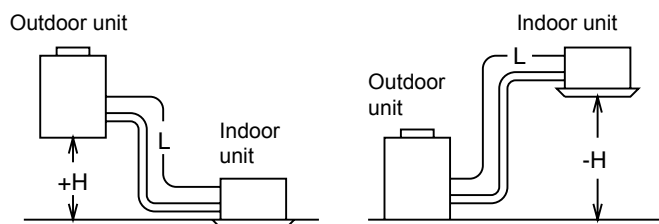

H:

Height between indoor unit and outdoor unit (m).

- H>0: Position of outdoor unit is higher than position of indoor unit (m).
- H<0: Position of outdoor unit is lower than position of indoor unit (m).

L:

Actual one-way piping length between indoor unit and outdoor unit (m).

EL:

Equivalent one-way piping length between indoor unit and outdoor unit (m).

- One 90° elbow is 0,5 m.
- One 180° bend is 1,5 m.
- One Multi-kit is 0,5 m.



NOTE:

- If EL is more than 100 m, increase both liquid pipe and gas pipe, by 1 size.
- In order to ensure correct unit selection, consider the farthest indoor unit.

Cooling capacity:

The cooling capacity should be corrected according to the following formula:

$$CCA = CC \times F$$

CCA:
 Actual corrected cooling capacity (kW).

CC:
 Cooling capacity from cooling capacity table (kW).

F:
 Correction factor based on the equivalent piping length (in %).

◆ **Cooling**

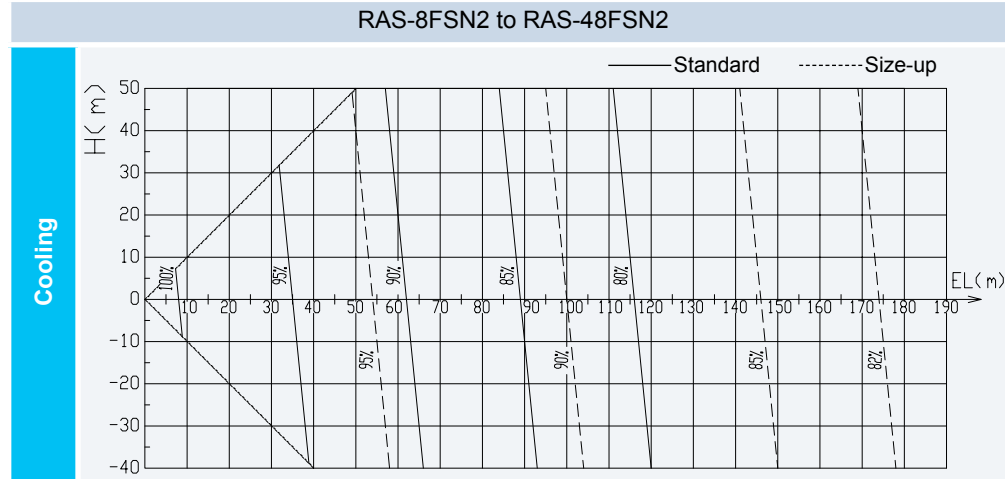

◆ **Heating**

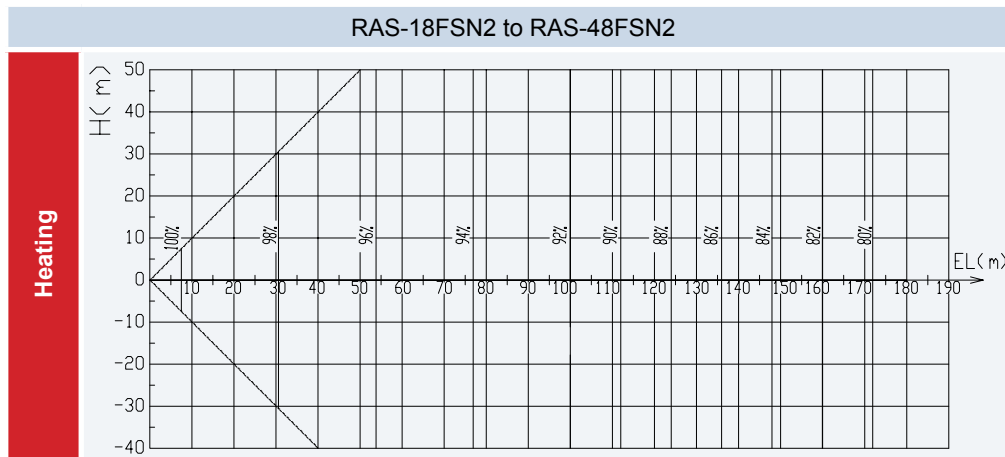
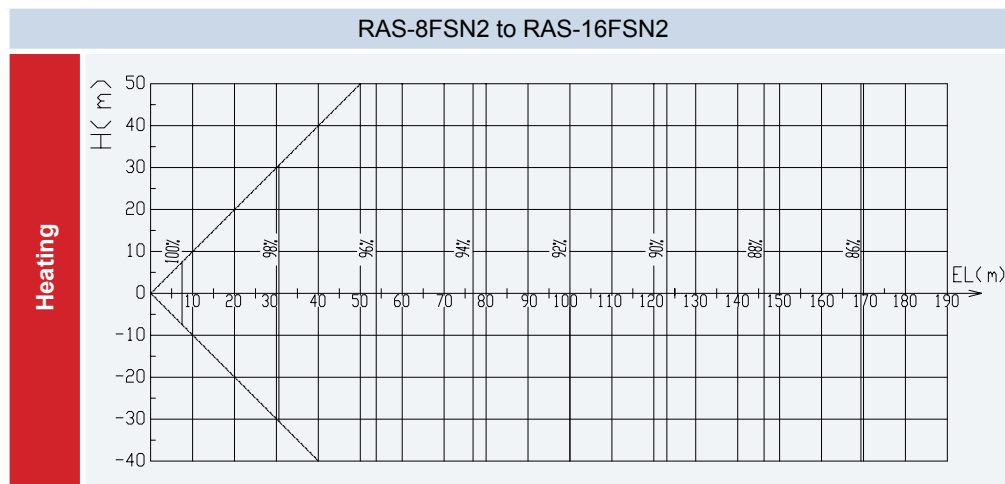

Heating capacity

The heating capacity should be corrected according to the following formula:

$$HCA = HC \times F$$

HCA:
 Actual corrected heating capacity (kW)

HC:
 Heating capacity from heating capacity table (kW).

F:
 Correction factor based on the equivalent piping length (in %).

4.6.2. Defrost correction factor

The heating capacity does not include operation during frost or defrosting.

When this type of operation is taken in account, the heating capacity must be corrected according to the following equation:

$$\text{Corrected heating capacity} = \text{correction factor} \times \text{heating capacity}$$

Outdoor inlet air temp. (°C DB) (HR = 85%)	-7	-5	-3	0	3	5	7
Defrosting correction factor f_d	0.95	0.93	0.88	0.85	0.87	0.90	1.00

i NOTE:

The correction factor is not valid for special conditions such as during snow or operation in a transitional period.

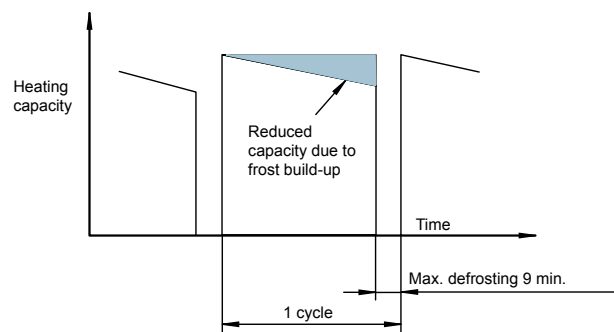

4.7. Sensible heat factor (SHF)

The sensible heat factor of indoor units at each fan speed (Hi, Me, Lo) based on the JIS Standard B8616, is given below:

Indoor unit model	SHF		
	Hi	Med	Low
RCI-1.0FSN2E	0.80	0.77	0.75
RCI-1.5FSN2E	0.77	0.75	0.73
RCI-2.0FSN2E	0.78	0.76	0.75
RCI-2.5FSN2E	0.73	0.71	0.69
RCI-3.0FSN2E	0.79	0.76	0.72
RCI-4.0FSN2E	0.78	0.75	0.72
RCI-5.0FSN2E	0.74	0.70	0.68
RCI-6.0FSN2E	0.73	0.69	0.68
RCIM-1.0FSN2	0.74	0.71	0.70
RCIM-1.5FSN2	0.74	0.71	0.70
RCIM-2.0FSN2	0.71	0.68	0.67
RCD-1.5FSN2	0.73	0.69	0.66
RCD-2.0FSN2	0.75	0.67	0.65
RCD-2.5FSN2	0.74	0.67	0.65
RCD-3.0FSN2	0.74	0.67	0.65
RCD-4.0FSN2	0.73	0.67	0.65
RCD-5.0FSN2	0.69	0.67	0.65
RPC-2.0FSN2E	0.72	0.70	0.67
RPC-2.5FSN2E	0.72	0.70	0.67
RPC-3.0FSN2E	0.72	0.70	0.67
RPC-4.0FSN2E	0.72	0.70	0.67
RPC-5.0FSN2E	0.72	0.70	0.67
RPC-6.0FSN2E	0.72	0.70	0.67
RPI-0.8FSN2E	0.81	0.69	0.69
RPI-1.0FSN2E	0.81	0.69	0.69
RPI-1.5FSN2E	0.73	0.69	0.65
RPI-2.0FSN2E	0.76	0.75	0.74
RPI-2.5FSN2E	0.76	0.74	0.72
RPI-3.0FSN2E	0.75	0.71	0.67
RPI-4.0FSN2E	0.73	0.71	0.65
RPI-5.0FSN2E	0.72	0.68	0.64
RPI-6.0FSN2E	0.72	0.69	0.67
RPI-8.0FSN2E	0.77	0.77	0.70
RPI-10.0FSN2E	0.79	0.79	0.72
RPIM-0.8FSN2E	0.81	0.69	0.69
RPIM-1.0FSN2E	0.81	0.69	0.69
RPIM-1.5FSN2E	0.71	0.68	0.64
RPK-1.0FSN2M	0.73	0.72	0.70
RPK-1.5FSN2M	0.73	0.72	0.70
RPK-2.0FSN2M	0.72	0.72	0.70
RPK-2.5FSN2M	0.72	0.72	0.70
RPK-3.0FSN2M	0.71	0.72	0.70
RPK-4.0FSN2M	0.71	0.72	0.70
RPF-1.0FSN2E	0.73	0.69	0.65
RPF-1.5FSN2E	0.73	0.69	0.65
RPF-2.0FSN2E	0.73	0.69	0.65
RPF-2.5FSN2E	0.73	0.69	0.65
RPFI-1.0FSN2E	0.73	0.69	0.65
RPFI-1.5FSN2E	0.73	0.69	0.65
RPFI-2.0FSN2E	0.73	0.69	0.65
RPFI-2.5FSN2E	0.73	0.69	0.65

◆ The following example shows the method for calculating the factor for latent and sensible heat .

Selected model	Indoor unit				
	RPI-2.0	RPI-2.5	RPI-3.0	RPI-4.0	RPI-5.0
Actual capacity	Cooling mode				
	4.34	5.43	6.51	8.68	10.85

RPI-2.0 High fan speed	Sensible load		Latent load	
	Performance capacity in cooling mode		Performance capacity in cooling mode	
	x Sensible heat factor		x (1-Sensible heat factor)	
	4.34 x 0.76 = 3.30 kW		4.34 x 0.24 = 1.04 kW	

4.8. Sound data

Model: RAS-8FSN2 Power supply: 380/415 V, 50 Hz
Measurement point: 1.5 meters from floor level
1 meter from the unit's front surface.
Sound criteria curve

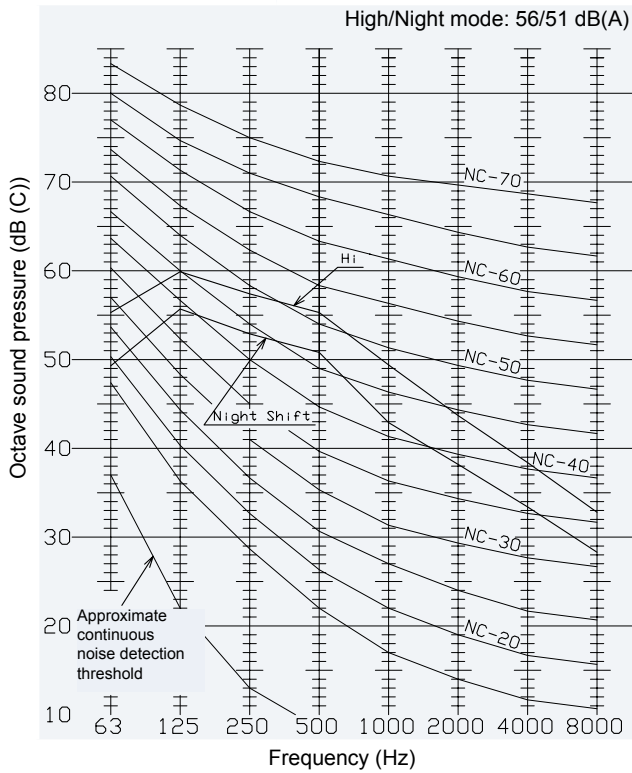

Model: RAS-10FSN2 Power supply: 380/415 V, 50 Hz
Measurement point: 1.5 meters from floor level
1 meter from the unit's front surface.
Sound criteria curve

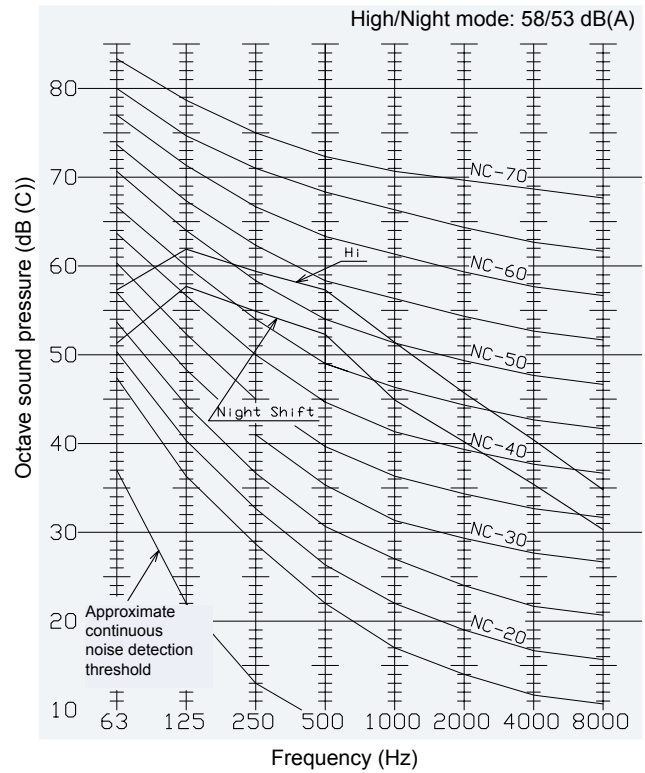

Model: RAS-12FSN2 Power supply: 380/415 V, 50 Hz
Measurement point: 1.5 meters from floor level
1 meter from the unit's front surface.
Sound criteria curve

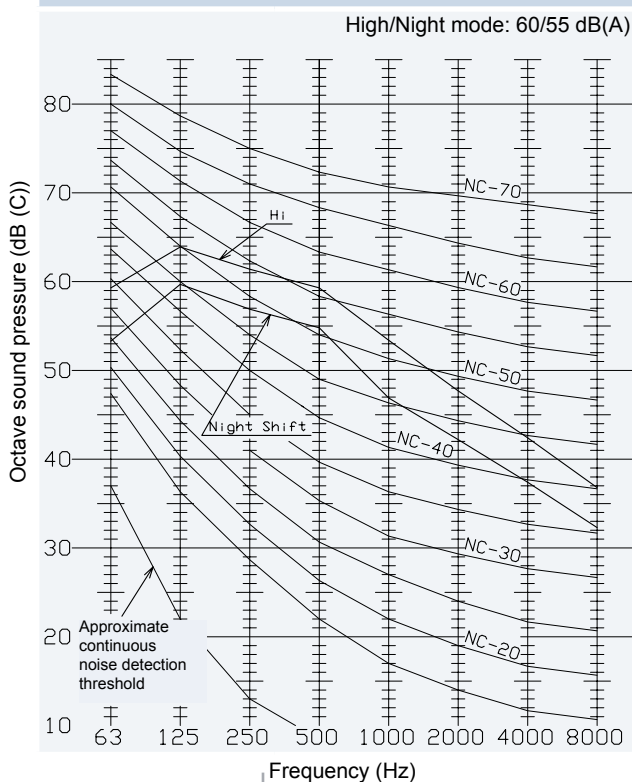

Model: RAS-14FSN2 Power supply: 380/415 V, 50 Hz
Measurement point: 1.5 meters from floor level
1 meter from the unit's front surface.
Sound criteria curve

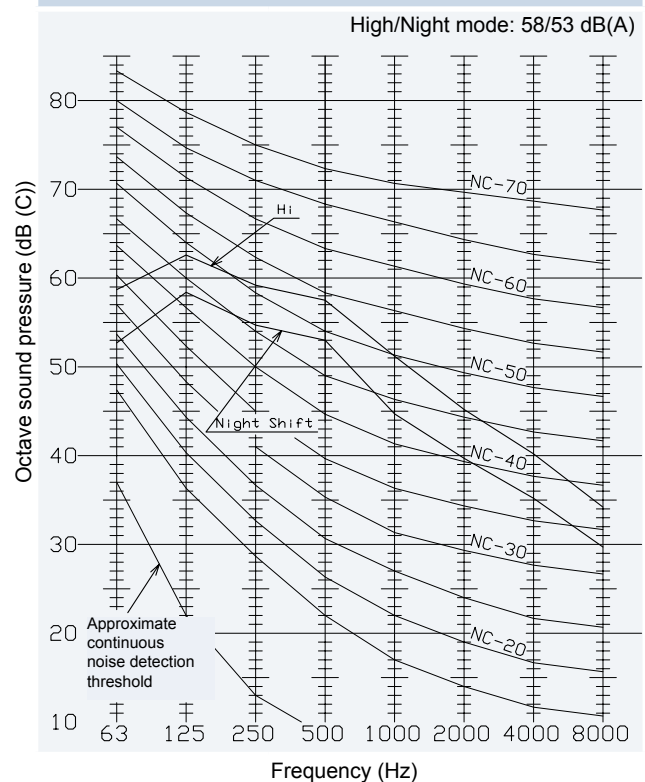

Model: RAS-16FSN2 Power supply: 380/415 V, 50 Hz
 Measurement point: 1.5 meters from floor level
 1 meter from the unit's front surface.
 Sound criteria curve

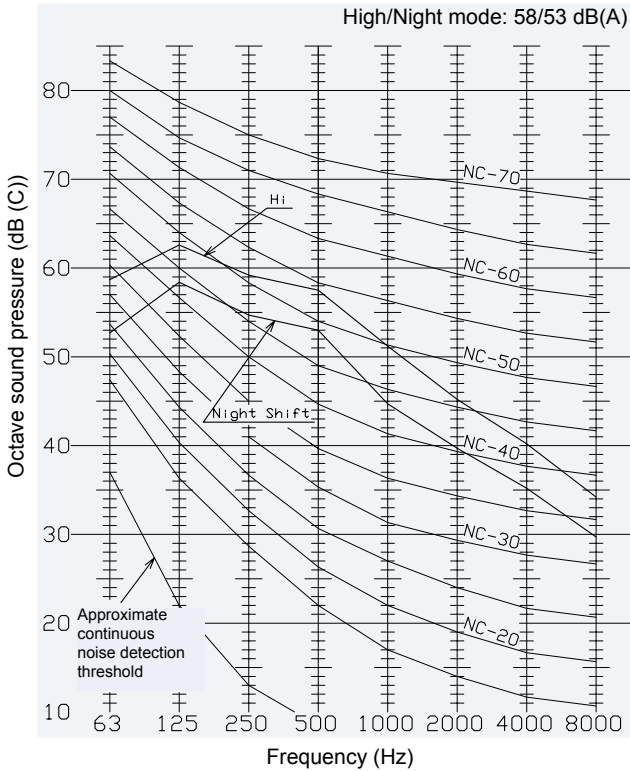

Model: RAS-18FSN2 Power supply: 380/415 V, 50 Hz
 Measurement point: 1.5 meters from floor level
 1 meter from the unit's front surface.
 Sound criteria curve

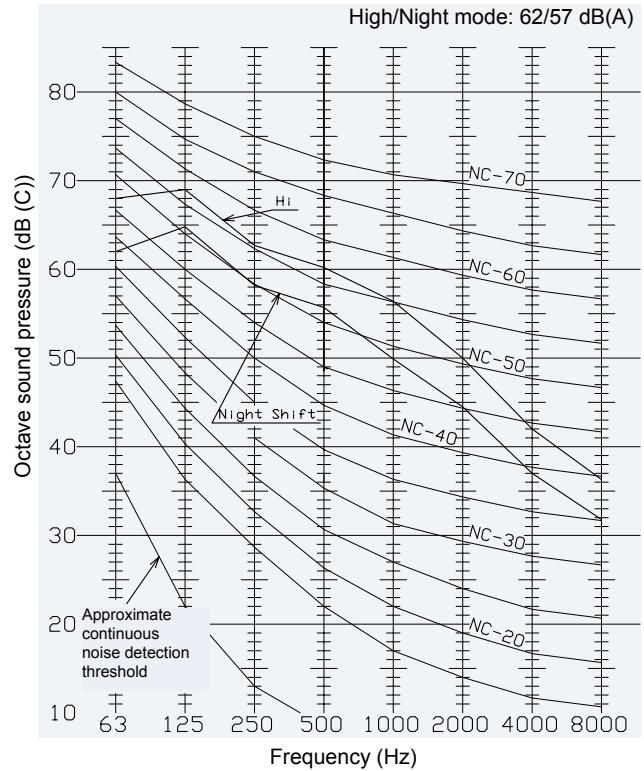

Model: RAS-20FSN2 Power supply: 380/415 V, 50 Hz
 Measurement point: 1.5 meters from floor level
 1 meter from the unit's front surface.
 Sound criteria curve

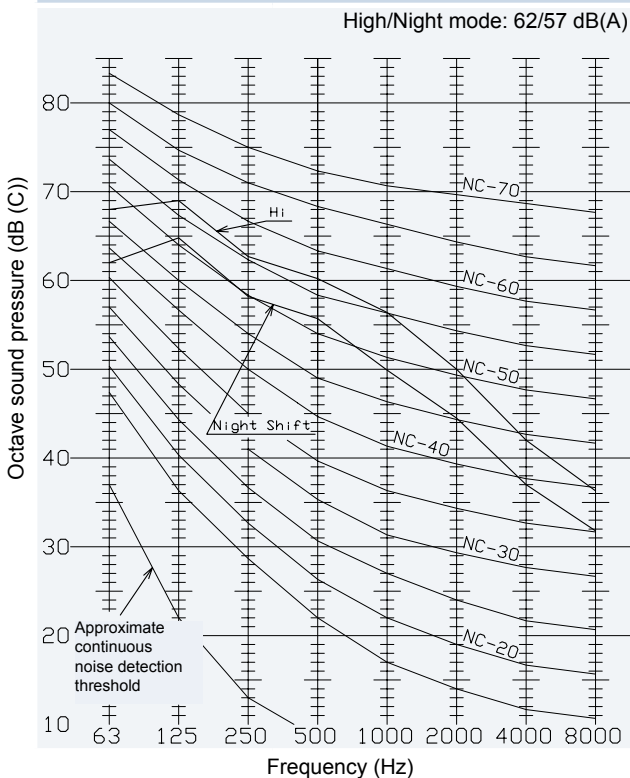

Model: RAS-22FSN2 Power supply: 380/415 V, 50 Hz
 Measurement point: 1.5 meters from floor level
 1 meter from the unit's front surface.
 Sound criteria curve

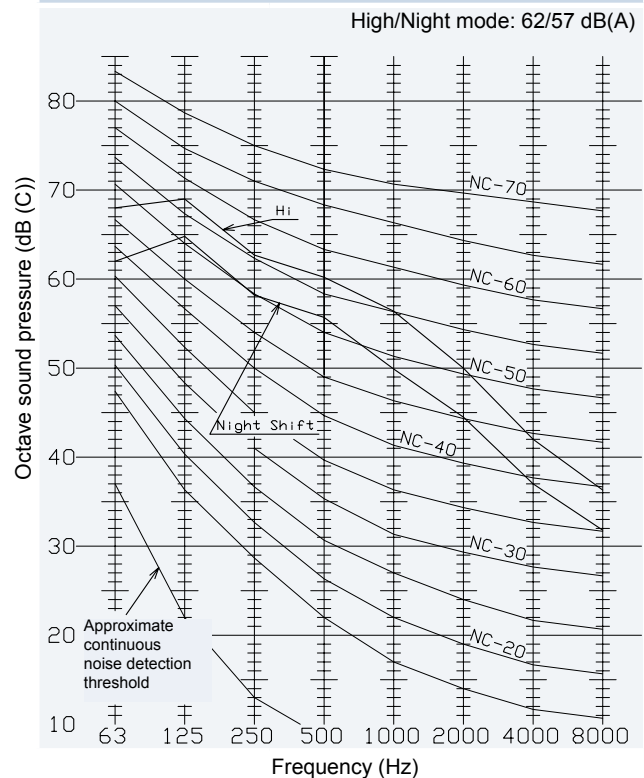

4

Model: RAS-24FSN2 Power supply: 380/415 V, 50 Hz
Measurement point: 1.5 meters from floor level
1 meter from the unit's front surface.
Sound criteria curve

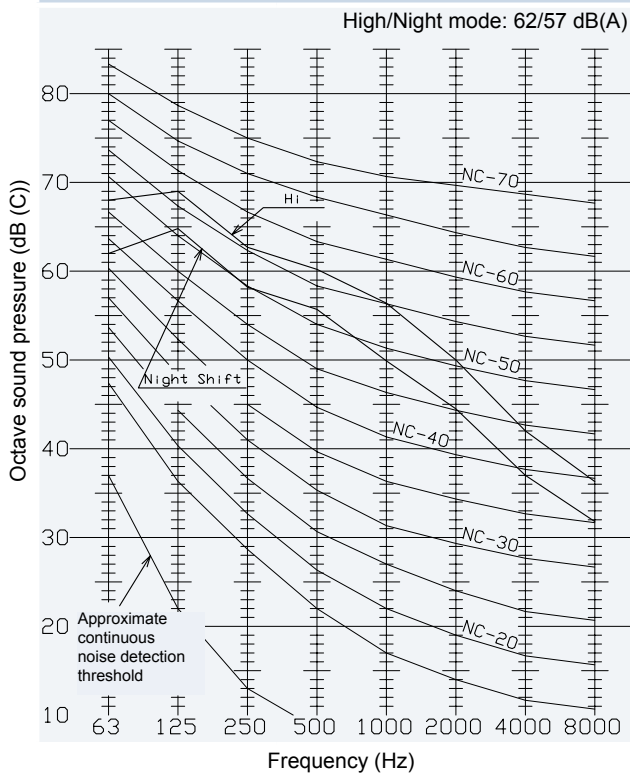

Model: RAS-26FSN2 Power supply: 380/415 V, 50 Hz
Measurement point: 1.5 meters from floor level
1 meter from the unit's front surface.
Sound criteria curve

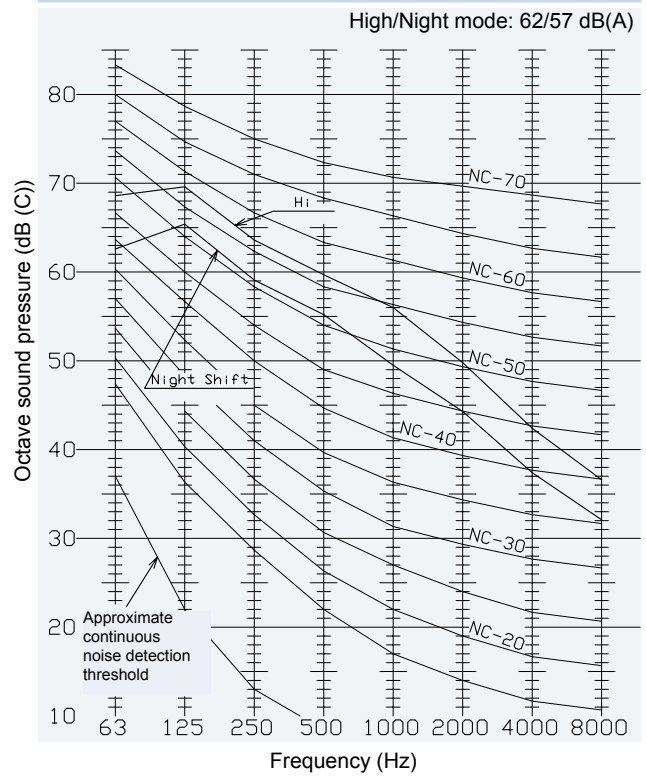

Model: RAS-28FSN2 Power supply: 380/415 V, 50 Hz
Measurement point: 1.5 meters from floor level
1 meter from the unit's front surface.
Sound criteria curve

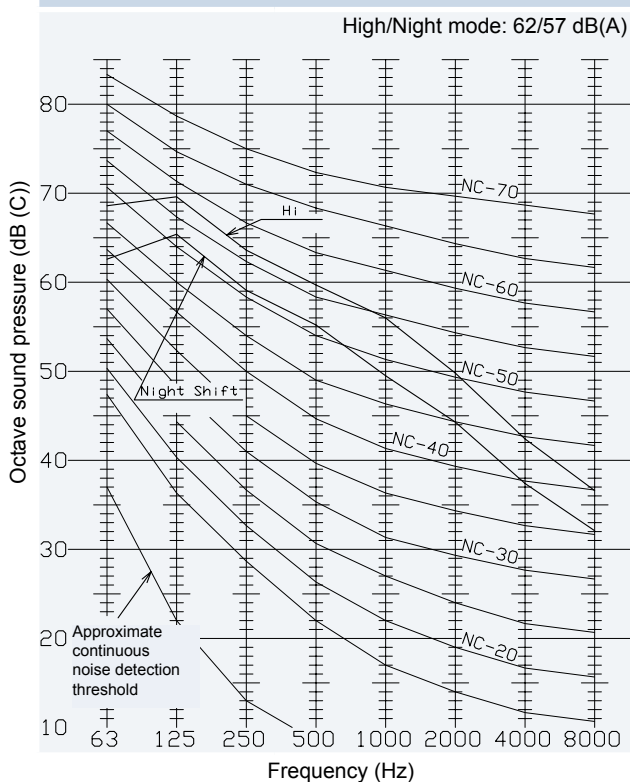

Model: RAS-30FSN2 Power supply: 380/415 V, 50 Hz
Measurement point: 1.5 meters from floor level
1 meter from the unit's front surface.
Sound criteria curve

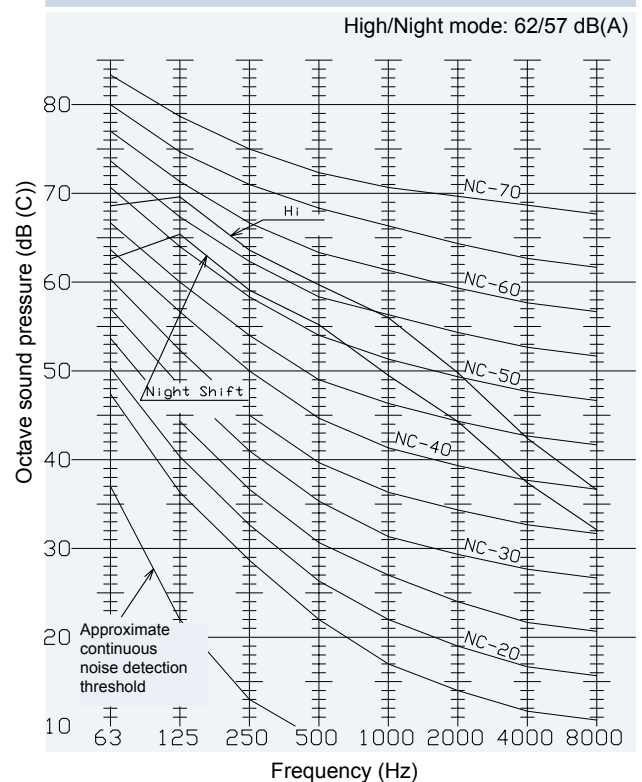

Model: RAS-32FSN2 Power supply: 380/415 V, 50 Hz
 Measurement point: 1.5 meters from floor level
 1 meter from the unit's front surface.
 Sound criteria curve
 High/Night mode: 62/57 dB(A)

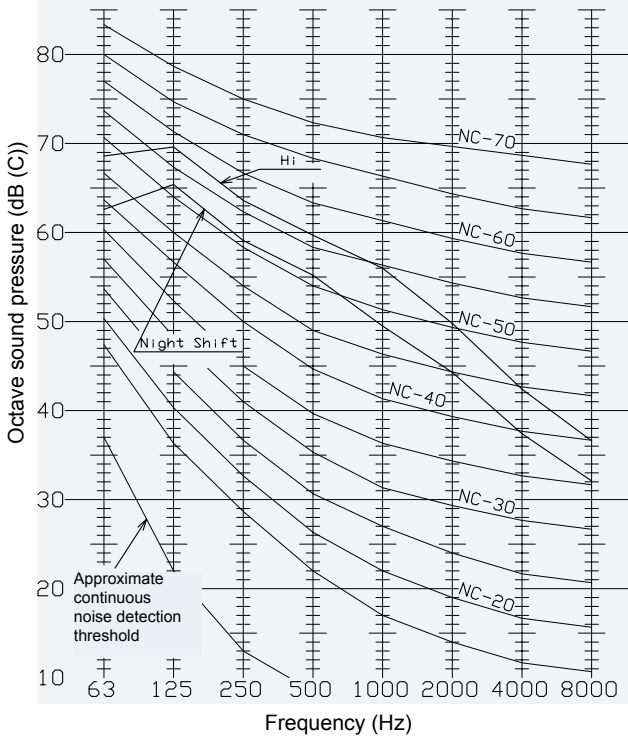

Model: RAS-34FSN2 Power supply: 380/415 V, 50 Hz
 Measurement point: 1.5 meters from floor level
 1 meter from the unit's front surface.
 Sound criteria curve
 High/Night mode: 64/59 dB(A)

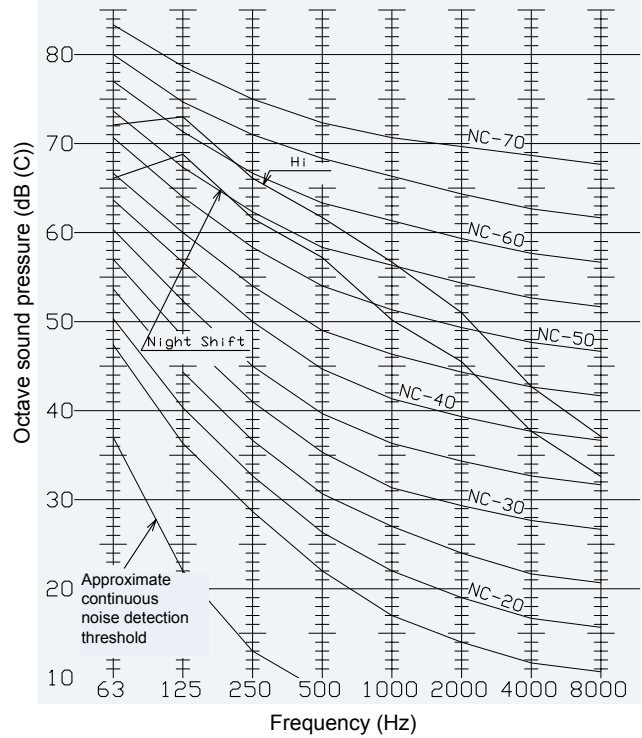

Model: RAS-36FSN2 Power supply: 380/415 V, 50 Hz
 Measurement point: 1.5 meters from floor level
 1 meter from the unit's front surface.
 Sound criteria curve
 High/Night mode: 64/59 dB(A)

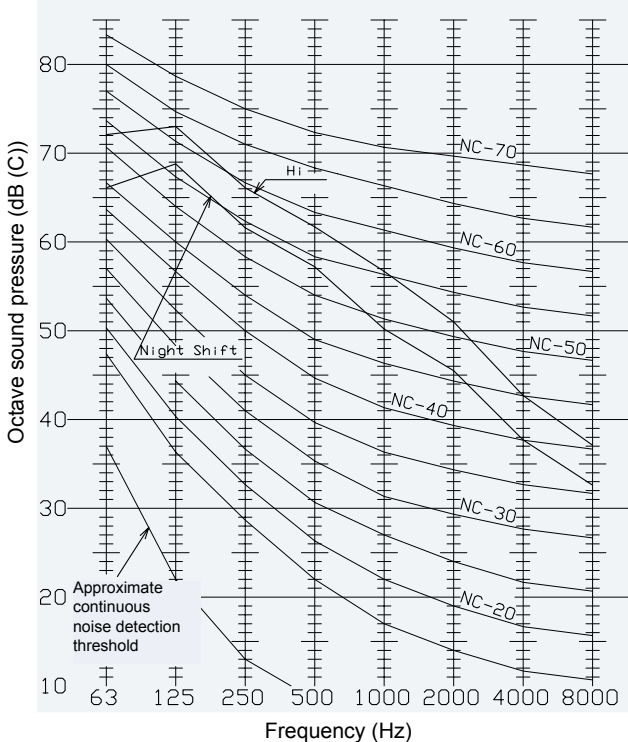

Model: RAS-38FSN2 Power supply: 380/415 V, 50 Hz
 Measurement point: 1.5 meters from floor level
 1 meter from the unit's front surface.
 Sound criteria curve
 High/Night mode: 64/59 dB(A)

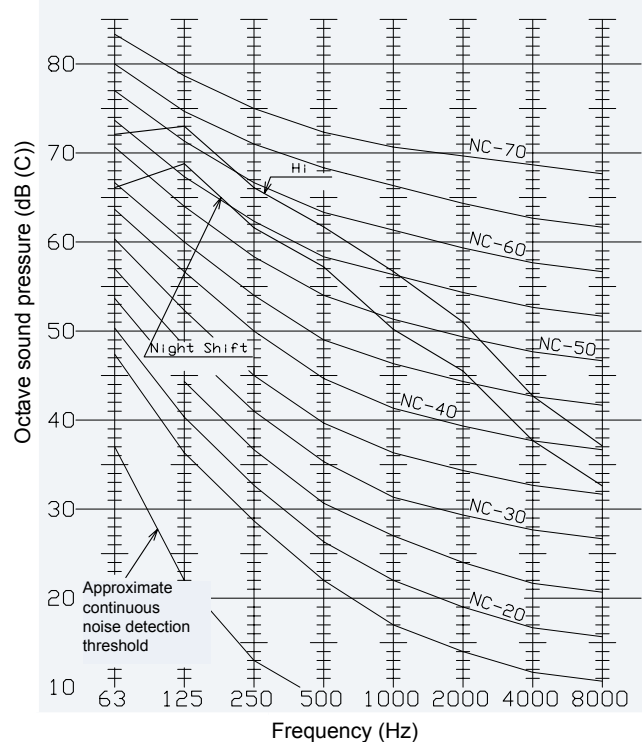

Model: RAS-40FSN2 Power supply: 380/415 V, 50 Hz
Measurement point: 1.5 meters from floor level
1 meter from the unit's front surface.
Sound criteria curve
High/Night mode: 64/59 dB(A)

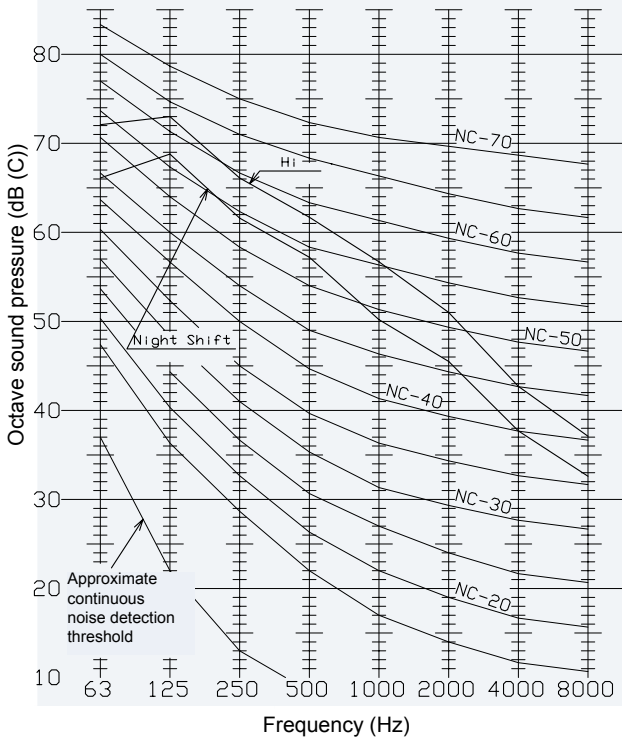

Model: RAS-42FSN2 Power supply: 380/415 V, 50 Hz
Measurement point: 1.5 meters from floor level
1 meter from the unit's front surface.
Sound criteria curve
High/Night mode: 64/59 dB(A)

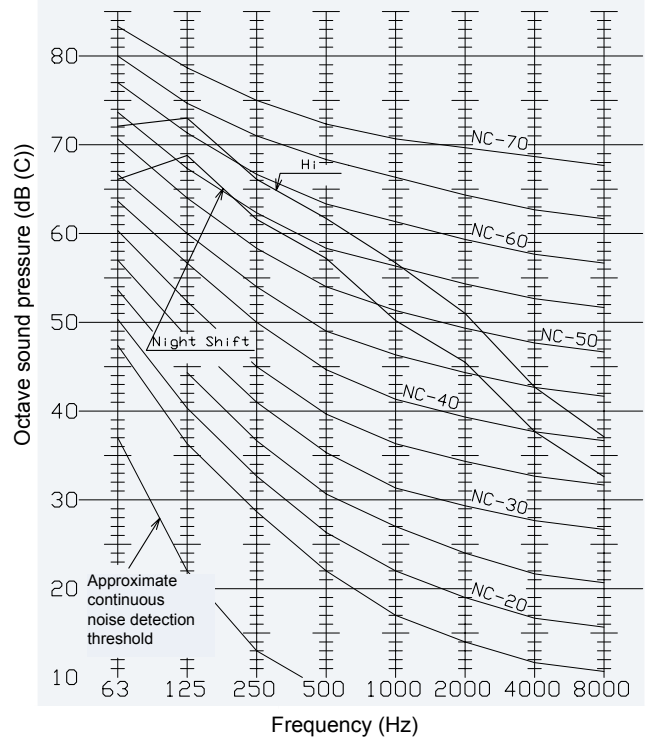

Model: RAS-44FSN2 Power supply: 380/415 V, 50 Hz
Measurement point: 1.5 meters from floor level
1 meter from the unit's front surface.
Sound criteria curve
High/Night mode: 64/59 dB(A)

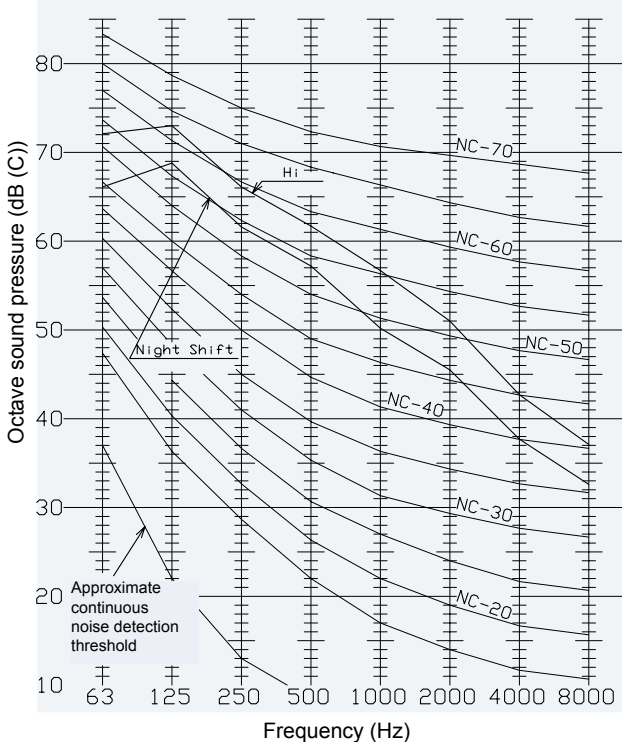

Model: RAS-46FSN2 Power supply: 380/415 V, 50 Hz
Measurement point: 1.5 meters from floor level
1 meter from the unit's front surface.
Sound criteria curve
High/Night mode: 64/59 dB(A)

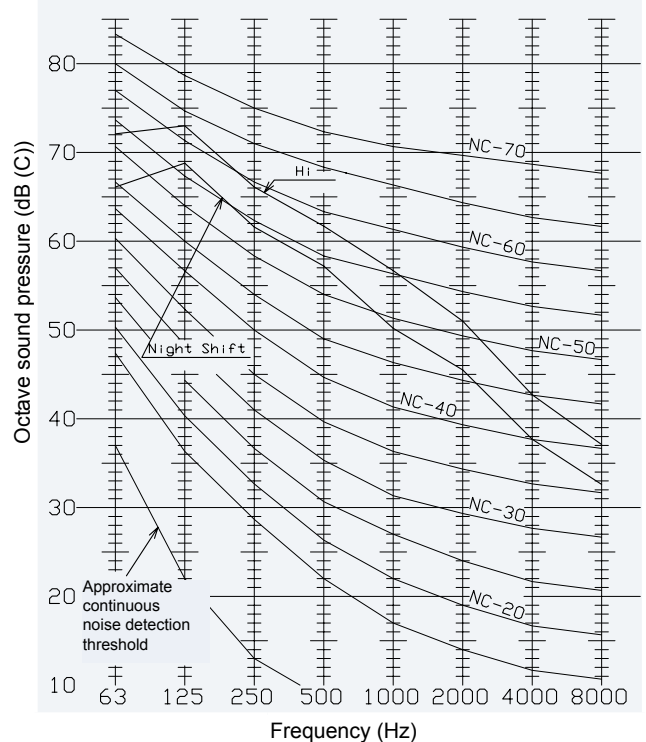

Model: RAS-48FSN2 Power supply: 380/415 V, 50 Hz

Measurement point: 1.5 meters from floor level
1 meter from the unit's front surface.

Sound criteria curve

High/Night mode: 64/59 dB(A)

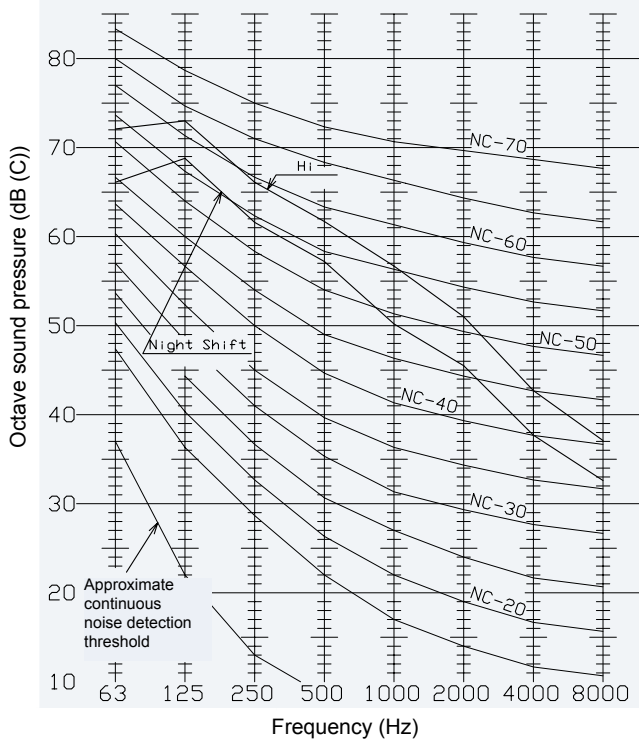

5. Working Range

This chapter shows the working range of the Hitachi SET FREE FSN2 Series.

Contents

5. Working Range.....	139
5.1. Power Supply	140
5.2. Temperature range	140

5.1. Power Supply

Operating voltage	90% to 110% of the nominal voltage
Voltage imbalance	Within a 3% deviation from each voltage at the main terminal of the outdoor unit
Starting voltage	Higher than 85% of the nominal voltage

Following Council Directive 89/336/EEC and amendments 92/31/EEC and 93/68/EEC, relating to electromagnetic compatibility, the following table indicates maximum permissible system impedance Z_{max} at the interface point of the user's power supply, in accordance with EN61000-3-11.

MODEL	Z_{max} (Ω)
RAS-8FSN2	-
RAS-10FSN2	-
RAS-12FSN2	-
RAS-14FSN2	0.28
RAS-16FSN2	0.27
RAS-18FSN2	0.22
RAS-22FSN2	0.17
RAS-26FSN2	0.15
RAS-28FSN2	0.14
RAS-30FSN2	0.13
RAS-32FSN2	0.12
RAS-34FSN2	0.11
RAS-36FSN2	0.11
RAS-38FSN2	0.10
RAS-40FSN2	0.09
RAS-42FSN2	0.09
RAS-44FSN2	0.09
RAS-46FSN2	0.08
RAS-48FSN2	0.07

5.2. Temperature range

The temperature range is indicated in the following table:

		Cooling Operation	Heating operation
Indoor temperature	Minimum	21 °C DB/15 °C WB	15 °C DB
	Maximum	32 °C DB/25 °C WB	27 °C DB
Outdoor temperature	Minimum	-5 °C DB (*)	-20 °C WB (**)
	Maximum	43 °C DB	15 °C WB

Temperature Range Diagram:

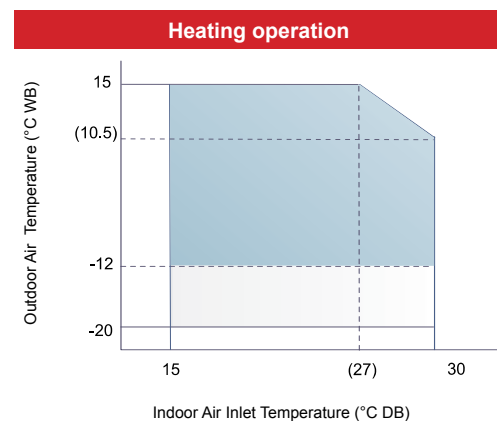
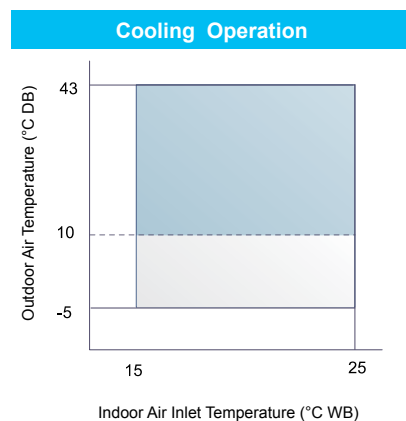

NOTES:

(*) The cooling operation may be changed to the fan operation interchangeably to avoid frost formation on the indoor unit heat exchanger under the condition below
Condition: Outdoor suction Air temp (°C DB): -5°C~10°C (approx.)

(**) Do not operate heating continuously for a long period of time under the condition below
Condition: Outdoor suction Air temp (°C WB): -20°C~12°C (for the specific time such as the activation of the unit in the morning)

DB: dry bulb; WB: wet bulb

Operation control range

6. Refrigerant Cycle

This chapter shows the refrigerant cycle for each unit of the HITACHI SET FREE FSN2 series.

Contents

6. Refrigerant Cycle.....	141
6.1. Refrigerant cycle for RAS-8~12FSN2	142
6.2. Refrigerant cycle for RAS-14~16FSN2	143
6.3. Refrigerant cycle for RAS-18~20FSN2	144
6.4. Refrigerant cycle for RAS-22~24FSN2	145
6.5. Refrigerant cycle for RAS-26~28FSN2	146
6.6. Refrigerant cycle for RAS-30~36FSN2	147
6.7. Refrigerant cycle for RAS-38~42FSN2	148
6.8. Refrigerant cycle for RAS-44~48FSN2	149

6.1. Refrigerant cycle for RAS-8~12FSN2

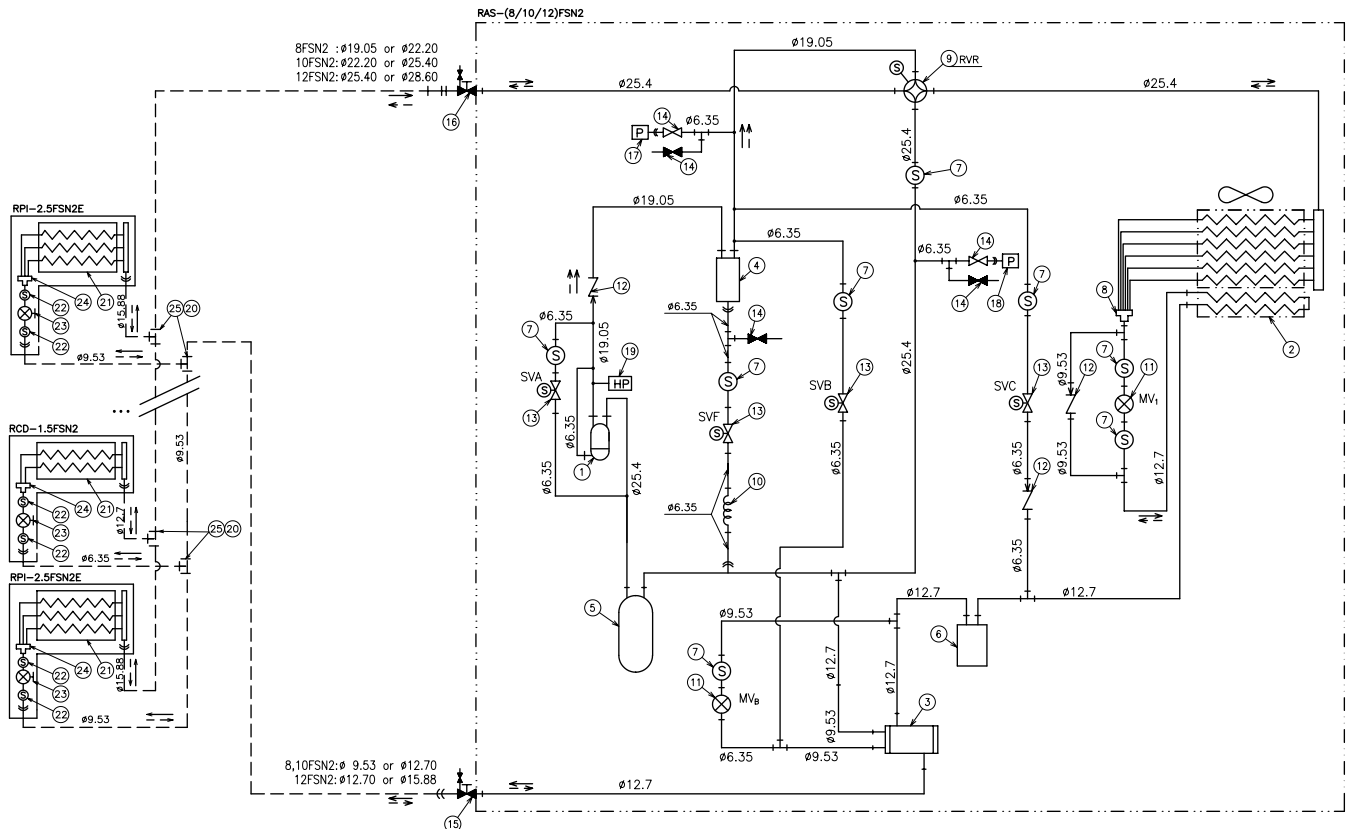

						R410A	4.15 MPa
Refrigerant flow for cooling	Refrigerant flow for heating	Refrigerant piping in the installation	Connection with flare nut	Flange connection	Brazing connection	Refrigerant	Airtight test pressure

no	Item	no	Item	no	Item
1	Compressor	10	Capillary tube	19	High pressure switch for protection
2	Heat exchanger	11	Micro-computer control expansion valve	20	Multi-Kit MW-102AN
3	Plate heat exchanger	12	Check valve	21	Heat exchanger indoor
4	Oil separator	13	Solenoid valve (*)	22	Strainer indoor
5	Accumulator	14	Check joint	23	Expansion valve indoor
6	Receiver	15	Stop Valve for liquid line	24	Distributor indoor
7	Strainer	16	Stop Valve for gas line	25	Multi-Kit MW-102AN
8	Distributor	17	Sensor for Refrigerant Pressure (High pressure sensor)		
9	Reversing valve	18	Sensor for Refrigerant Pressure (Low pressure sensor)		

(*) (SVB: Gas Bypass, SVA: Pressure control, SVF: Oil return, SVC: Liquid Bypass)

6.2. Refrigerant cycle for RAS-14~16FSN2

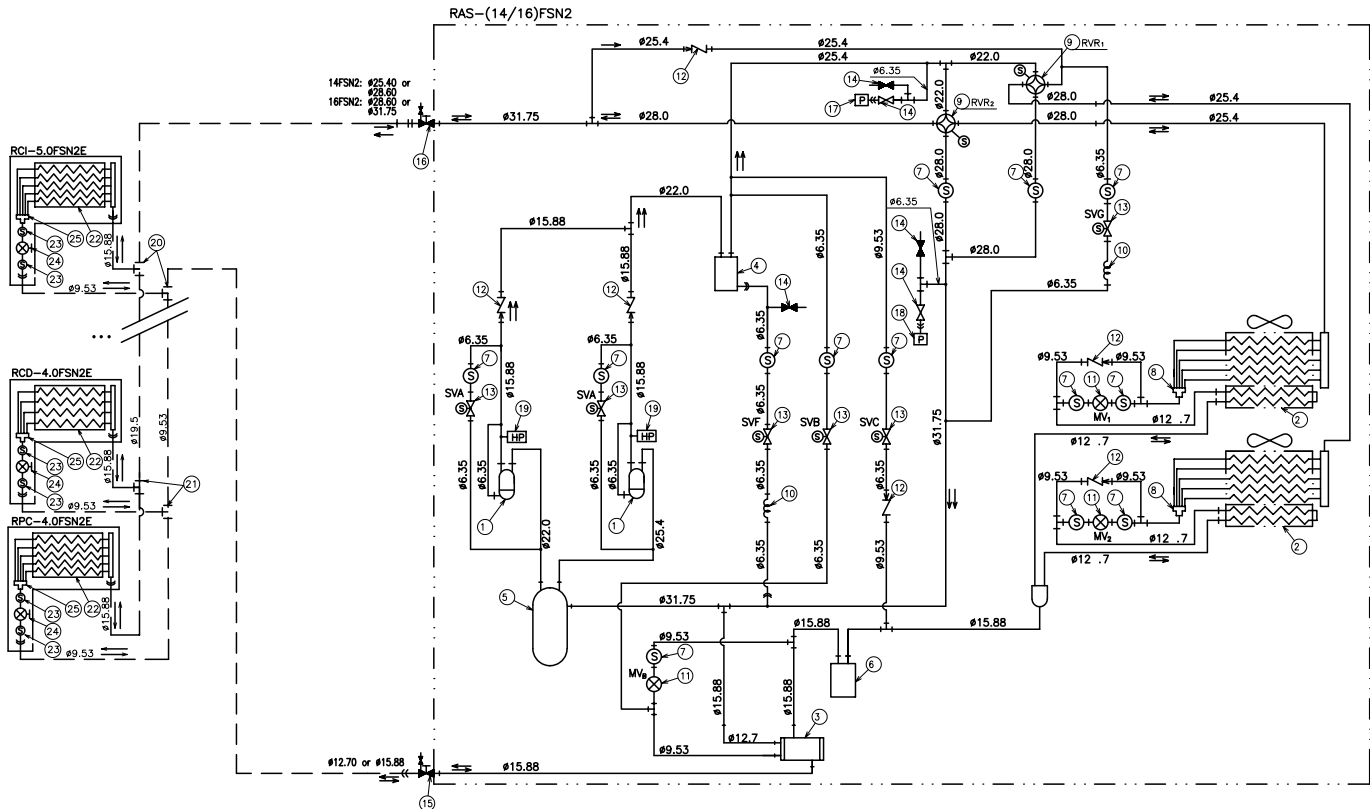

6

						R410A	4.15 MPa
Refrigerant flow for cooling	Refrigerant flow for heating	Refrigerant piping in the installation	Connection with flare nut	Flange connection	Brazing connection	Refrigerant	Airtight test pressure

no	Item	no	Item	no	Item
1	Compressor	10	Capillary tube	19	High pressure switch for protection
2	Heat exchanger	11	Micro-computer control expansion valve	20	Multi-Kit MW-242AN
3	Plate heat exchanger	12	Check valve	21	Multi-Kit MW-102AN
4	Oil separator	13	Solenoid valve (*)	22	Heat exchanger indoor
5	Accumulator	14	Check joint	23	Strainer indoor
6	Receiver	15	Stop Valve for liquid line	24	Expansion valve indoor
7	Strainer	16	Stop Valve for gas line	25	Distributor indoor
8	Distributor	17	Sensor for Refrigerant Pressure (High pressure sensor)		
9	Reversing valve	18	Sensor for Refrigerant Pressure (Low pressure sensor)		

(*) (SVB: Gas Bypass, SVA: Pressure control, SVF: Oil return, SVC: Liquid Bypass)

6.3. Refrigerant cycle for RAS-18~20FSN2

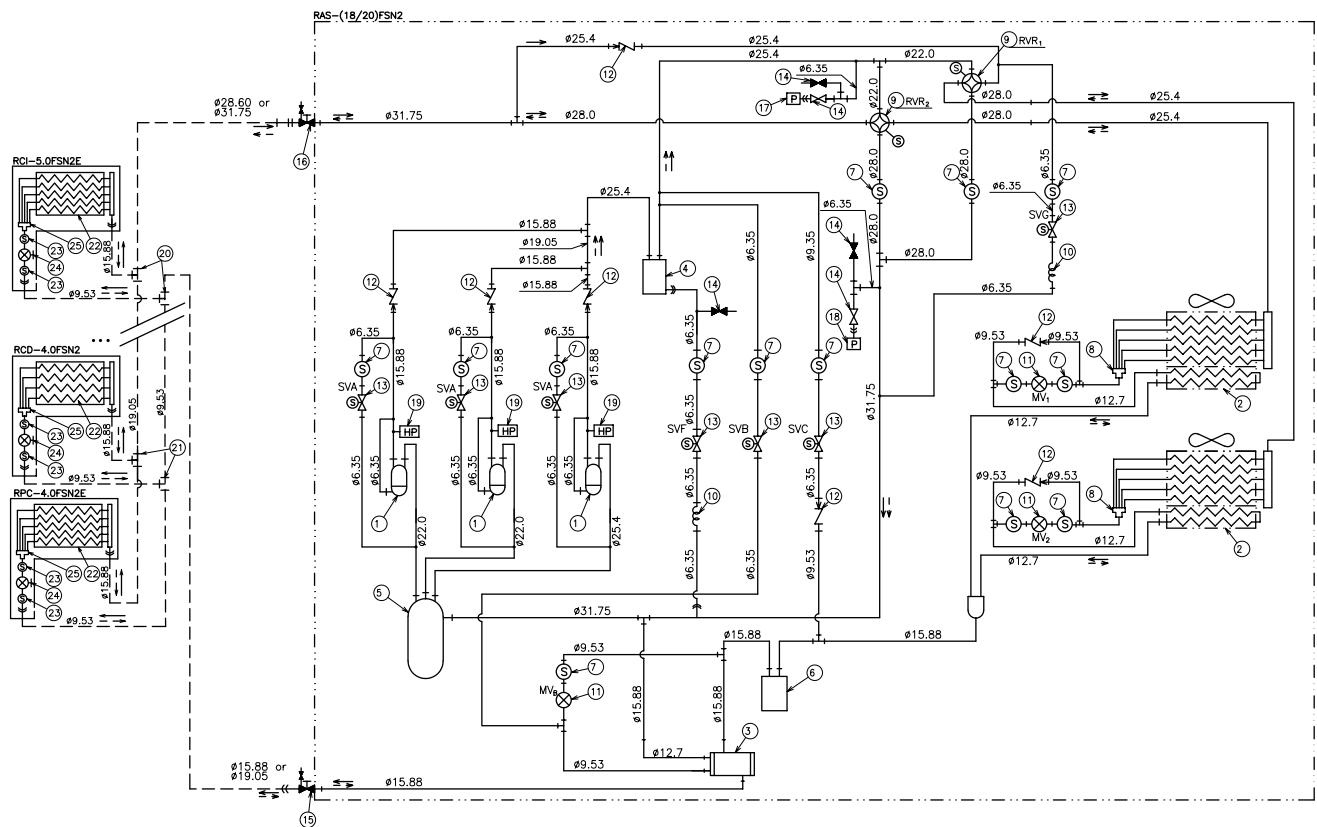

						R410A	4.15 MPa
Refrigerant flow for cooling	Refrigerant flow for heating	Refrigerant piping in the installation	Connection with flare nut	Flange connection	Brazing connection	Refrigerant	Airtight test pressure

no	Item	no	Item	no	Item
1	Compressor	10	Capillary tube	19	High pressure switch for protection
2	Heat exchanger	11	Micro-computer control expansion valve	20	Multi-Kit MW-242AN
3	Plate heat exchanger	12	Check valve	21	Multi-Kit MW-102AN
4	Oil separator	13	Solenoid valve (*)	22	Heat exchanger indoor
5	Accumulator	14	Check joint	23	Strainer indoor
6	Receiver	15	Stop Valve for liquid line	24	Expansion valve indoor
7	Strainer	16	Stop Valve for gas line	25	Distributor indoor
8	Distributor	17	Sensor for Refrigerant Pressure (High pressure sensor)		
9	Reversing valve	18	Sensor for Refrigerant Pressure (Low pressure sensor)		

(*) (SVB: Gas Bypass, SVA: Pressure control, SVF: Oil return, SVC: Liquid Bypass)

6.4. Refrigerant cycle for RAS-22~24FSN2

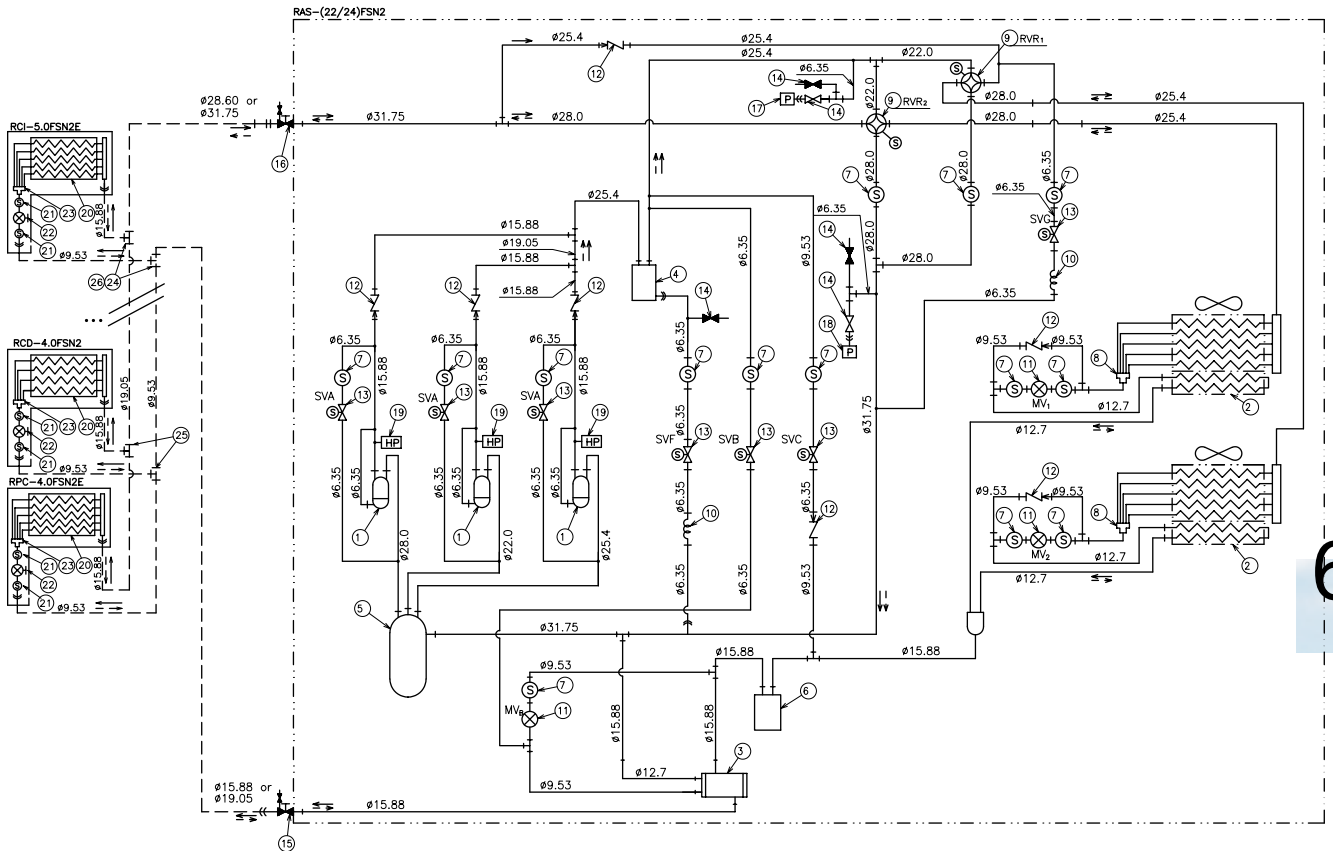

6

						R410A	4.15 MPa
Refrigerant flow for cooling	Refrigerant flow for heating	Refrigerant piping in the installation	Connection with flare nut	Flange connection	Brazing connection	Refrigerant	Airtight test pressure

No	Item	No.	Item	No	Item
1	Compressor	10	Capillary tube	19	High pressure switch for protection
2	Heat exchanger	11	Micro-computer control expansion valve	20	Heat exchanger indoor
3	Plate heat exchanger	12	Check valve	21	Strainer indoor
4	Oil separator	13	Solenoid valve (*)	22	Expansion valve indoor
5	Accumulator	14	Check joint	23	Distributor indoor
6	Receiver	15	Stop Valve for liquid line	24	Multi-Kit MW-242AN
7	Strainer	16	Stop Valve for gas line	25	Multi-Kit MW-102AN
8	Distributor	17	Sensor for Refrigerant Pressure (High pressure sensor)	26	Multi-Kit MW-242AN
9	Reversing valve	18	Sensor for Refrigerant Pressure (Low pressure sensor)		

(*) (SVB: Gas Bypass, SVA: Pressure control, SVF: Oil return, SVC: Liquid Bypass)

6.5. Refrigerant cycle for RAS-26~28FSN2

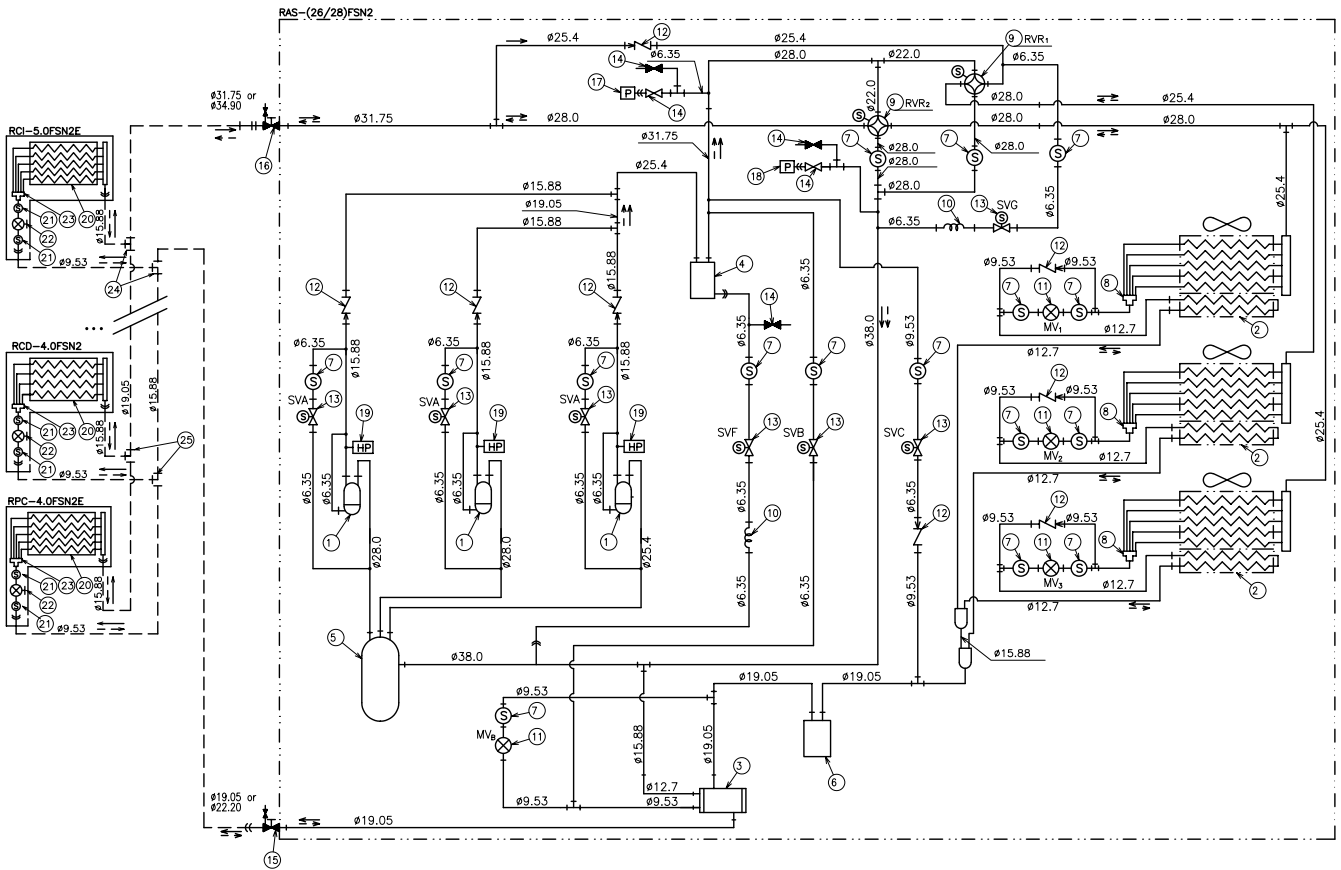

						R410A	4.15 MPa
Refrigerant flow for cooling	Refrigerant flow for heating	Refrigerant piping in the installation	Connection with flare nut	Flange connection	Brazing connection	Refrigerant	Airtight test pressure

No	Item	No	Item	No	Item
1	Compressor	10	Capillary tube	19	High pressure switch for protection
2	Heat exchanger	11	Micro-computer control expansion valve	20	Heat exchanger indoor
3	Plate heat exchanger	12	Check valve	21	Strainer indoor
4	Oil separator	13	Solenoid valve (*)	22	Expansion valve indoor
5	Accumulator	14	Check joint	23	Distributor indoor
6	Receiver	15	Stop Valve for liquid line	24	Multi-Kit MW-302AN
7	Strainer	16	Stop Valve for gas line	25	Multi-Kit MW-102AN
8	Distributor	17	Sensor for Refrigerant Pressure (High pressure sensor)		
9	Reversing valve	18	Sensor for Refrigerant Pressure (Low pressure sensor)		

(*) (SVB: Gas Bypass,SVA: Pressure control, SVF: Oil return, SVC: Liquid Bypass)

6.6. Refrigerant cycle for RAS-30~36FSN2

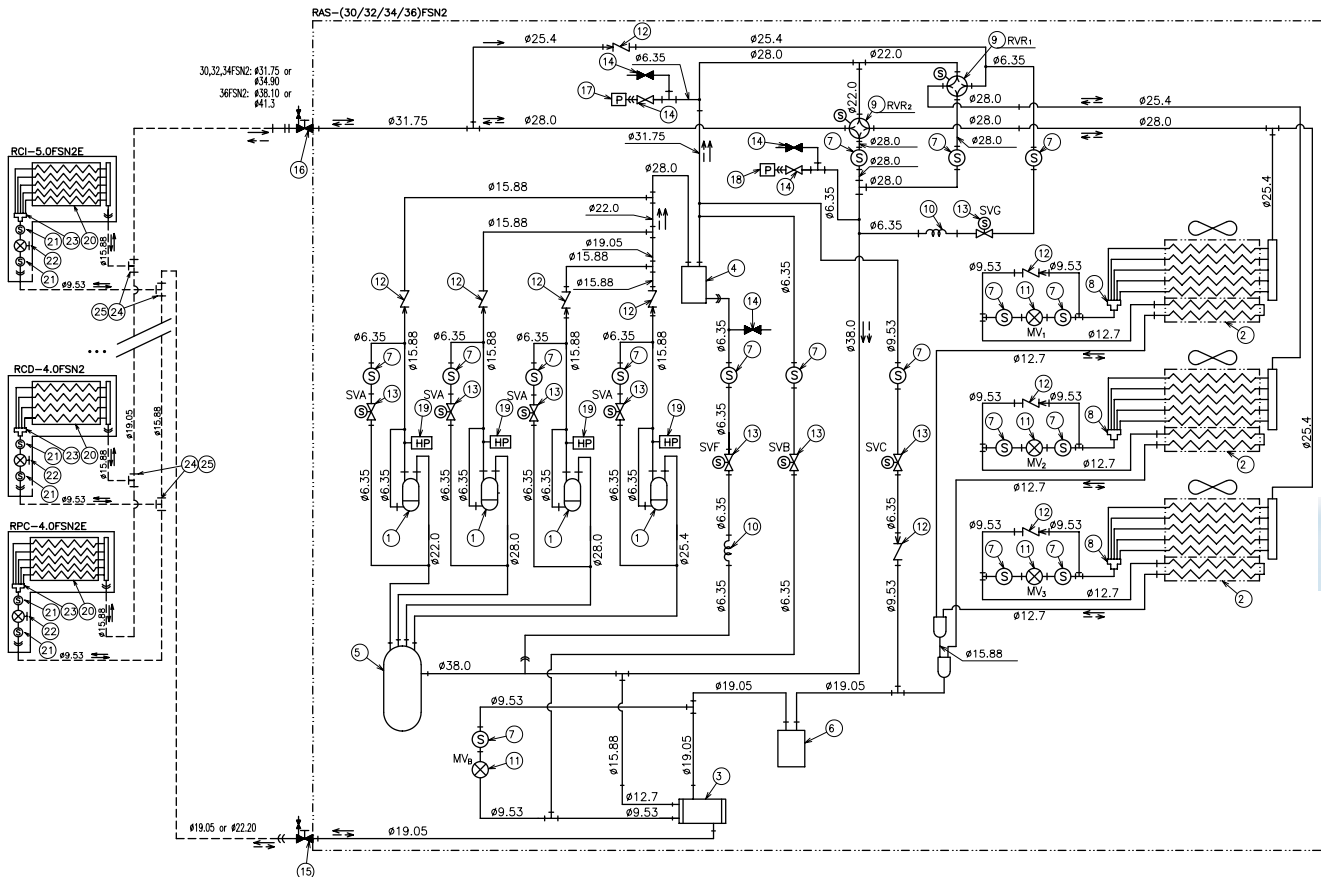

6

						R410A	4.15 MPa
Refrigerant flow for cooling	Refrigerant flow for heating	Refrigerant piping in the installation	Connection with flare nut	Flange connection	Brazing connection	Refrigerant	Airtight test pressure

No	Item	No	Item	No	Item
1	Compressor	10	Capillary tube	19	High pressure switch for protection
2	Heat exchanger	11	Micro-computer control expansion valve	20	Heat exchanger indoor
3	Plate heat exchanger	12	Check valve	21	Strainer indoor
4	Oil separator	13	Solenoid valve (*)	22	Expansion valve indoor
5	Accumulator	14	Check joint	23	Distributor indoor
6	Receiver	15	Stop Valve for liquid line	24	Multi-Kit MW-302AN
7	Strainer	16	Stop Valve for gas line	25	Multi-Kit MW-102AN
8	Distributor	17	Sensor for Refrigerant Pressure (High pressure sensor)		
9	Reversing valve	18	Sensor for Refrigerant Pressure (Low pressure sensor)		

(*) (SVB: Gas Bypass, SVA: Pressure control, SVF: Oil return, SVC: Liquid Bypass)

6.7. Refrigerant cycle for RAS-38~42FSN2

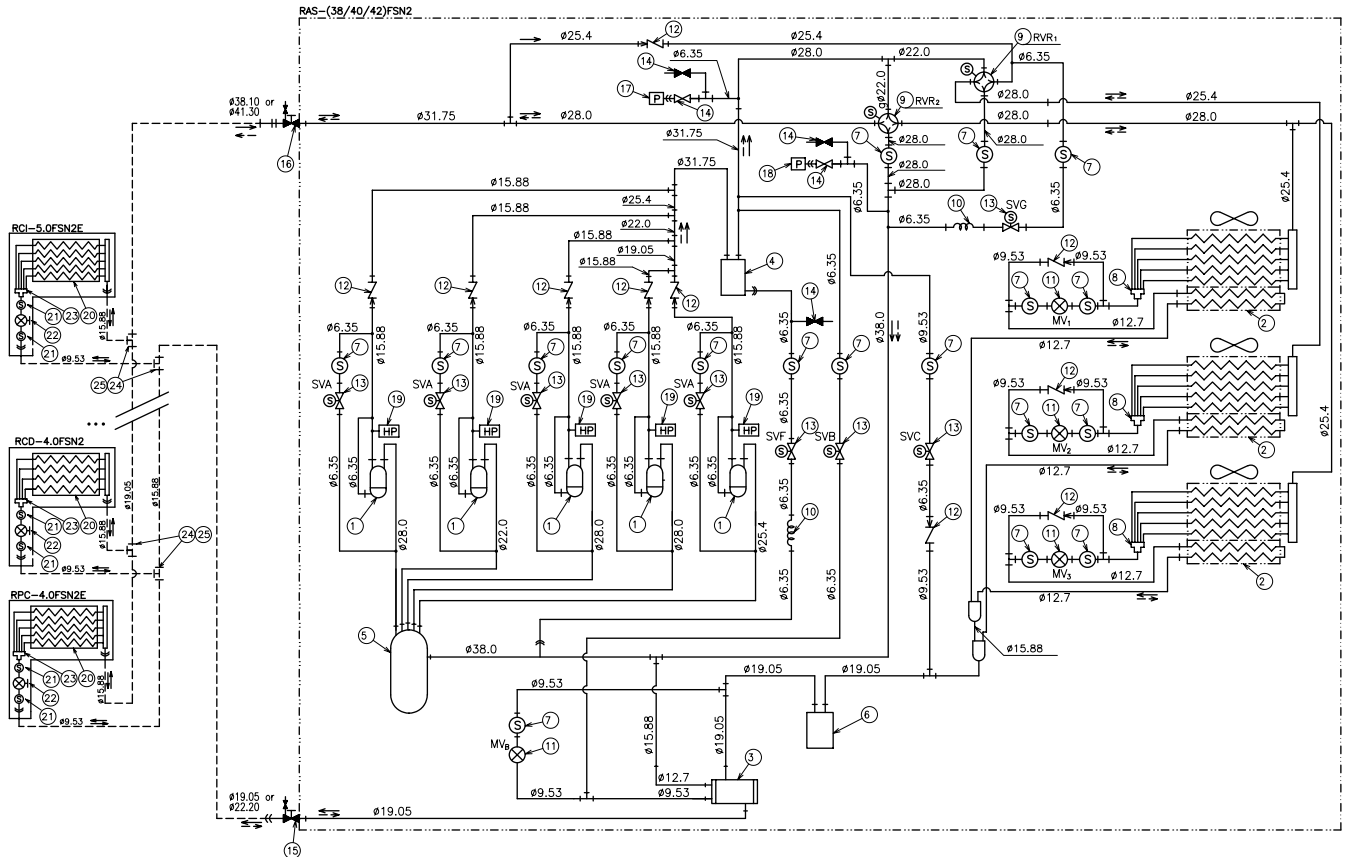

						R410A	4.15 MPa
Refrigerant flow for cooling	Refrigerant flow for heating	Refrigerant piping in the installation	Connection with flare nut	Flange connection	Brazing connection	Refrigerant :	Airtight test pressure

No	Item	No	Item	No	Item
1	Compressor	10	Capillary tube	19	High pressure switch for protection
2	Heat exchanger	11	Micro-computer control expansion valve	20	Heat exchanger indoor
3	Plate heat exchanger	12	Check valve	21	Strainer indoor
4	Oil separator	13	Solenoid valve (*)	22	Expansion valve indoor
5	Accumulator	14	Check joint	23	Distributor indoor
6	Receiver	15	Stop Valve for liquid line	24	Multi-Kit MW-302AN
7	Strainer	16	Stop Valve for gas line	25	Multi-Kit MW-102AN
8	Distributor	17	Sensor for Refrigerant Pressure (High pressure sensor)		
9	Reversing valve	18	Sensor for Refrigerant Pressure (Low pressure sensor)		

(*) (SVB: Gas Bypass, SVA: Pressure control, SVF: Oil return, SVC: Liquid Bypass)

6.8. Refrigerant cycle for RAS-44~48FSN2

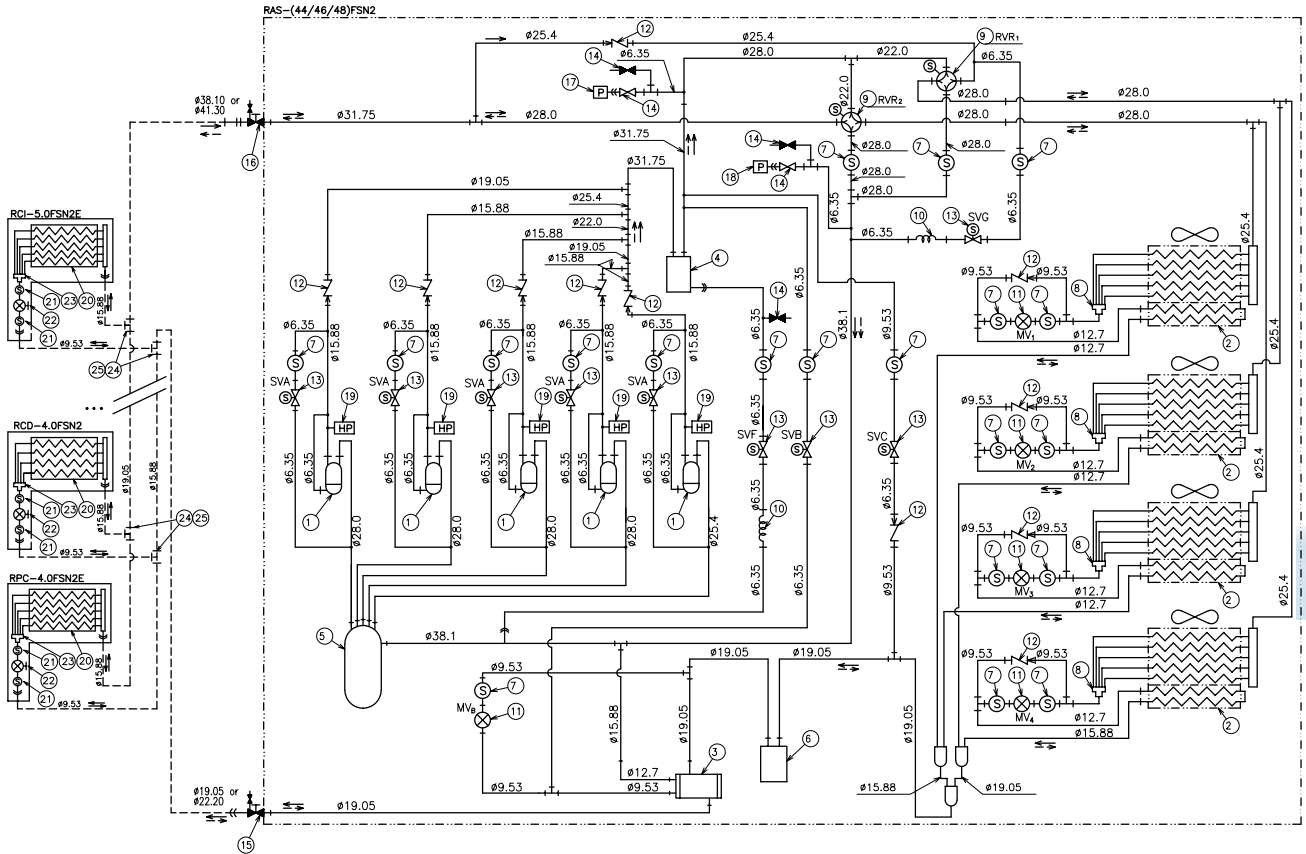

6

						R410A	4.15 MPa
Refrigerant flow for cooling	Refrigerant flow for heating	Refrigerant piping in the installation	Connection with flare nut	Flange connection	Brazing connection	Refrigerant :	Airtight test pressure

No	Item	No	Item	No	Item
1	Compressor	10	Capillary tube	19	High pressure switch for protection
2	Heat exchanger	11	Micro-computer control expansion valve	20	Heat exchanger indoor
3	Plate heat exchanger	12	Check valve	21	Strainer indoor
4	Oil separator	13	Solenoid valve (*)	22	Expansion valve indoor
5	Accumulator	14	Check joint	23	Distributor indoor
6	Receiver	15	Stop Valve for liquid line	24	Multi-Kit MW-302AN
7	Strainer	16	Stop Valve for gas line	25	Multi-Kit MW-102AN
8	Distributor	17	Sensor for Refrigerant Pressure (High pressure sensor)		
9	Reversing valve	18	Sensor for Refrigerant Pressure (Low pressure sensor)		

(*) (SVB: Gas Bypass, SVA: Pressure control, SVF: Oil return, SVC: Liquid Bypass)

7. Piping and refrigerant charge

This chapter shows the piping and refrigerant charge for each unit of the HITACHI SET FREE FSN2 series.

Contents

7. Piping and Refrigerant Load.....	151
7.1. Refrigerant piping selection.....	152
7.1.1. Minimum and maximum number of indoor units per outdoor unit.....	152
7.1.2. Refrigerant piping range.....	153
7.1.3. Refrigerant piping length by dip switch setting.....	153
7.1.4. Piping size and multiple connections kit.....	154
7.2. Multi-kits and distributors.....	156
7.2.1. Size data.....	156
7.2.2. Distribution method.....	158
7.2.3. Copper pipes and sizes.....	161
7.3. Amount refrigerant charge.....	163
7.3.1. Additional refrigerant charge calculation (R410A).....	163
7.3.2. Samples.....	165
7.4. Caution on refrigerant leakage.....	172
7.4.1. Maximum permissible concentration of HCFC/HFC gas.....	172
7.4.2. Calculation of refrigerant concentration.....	172
7.4.3. Countermeasure for refrigerant leakage.....	173

7.1. Refrigerant piping selection

The Set Free FSN2 system was designed to take into consideration all possible installation types. Therefore, HITACHI is using two different refrigerant pipe distributors: Multiple connection kits system and distributor system.

7.1.1. Minimum and maximum number of indoor units per outdoor unit

With Set Free FSN2 system it's able to connect one outdoor unit with up to 46 indoor units.

Utilizing an inverter control, a wide range of operation capacity control is also available. A maximum total combination horsepower of 130% and a minimum total combination horsepower of 50% can be chosen by combination of the indoor units when compared with the nominal outdoor unit capacity. Therefore, the new system can meet individual air conditioning requirements in most office buildings.

Outdoor unit	Indoor unit			
	Minimum combination capacity (HP)	Maximum combination capacity (HP)	Combination quantity	Minimum individual operation capacity (HP)
RAS-8FSN2	4.0	10.4	13 (8)	0.8
RAS-10FSN2	5.0	13.0	16 (8)	0.8
RAS-12FSN2	6.0	15.6	16 (8)	0.8
RAS-14FSN2	7.0	18.0	20 (12)	0.8
RAS-16FSN2	8.0	20.8	20 (12)	0.8
RAS-18FSN2	9.0	23.4	20 (16)	0.8
RAS-20FSN2	10.0	26.0	20 (16)	0.8
RAS-22FSN2	11.0	28.6	20 (16)	0.8
RAS-24FSN2	12.0	31.2	27 (20)	0.8
RAS-26FSN2	13.0	33.8	29 (20)	0.8
RAS-28FSN2	14.0	36.4	31 (24)	0.8
RAS-30FSN2	15.0	39.0	32 (24)	0.8
RAS-32FSN2	16.0	41.6	32 (24)	0.8
RAS-34FSN2	17.0	44.2	34 (28)	0.8
RAS-36FSN2	18.0	46.8	34 (28)	0.8
RAS-38FSN2	19.0	49.4	38 (32)	0.8
RAS-40FSN2	20.0	52.0	38 (32)	0.8
RAS-42FSN2	21.0	54.6	42 (34)	0.8
RAS-44FSN2	22.0	57.2	42 (34)	0.8
RAS-46FSN2	23.0	59.8	46 (38)	0.8
RAS-48FSN2	24.0	62.4	46 (38)	0.8



NOTE:

(): Maximum number of minimum capacity indoor units connectable
If you connect more, the perception of cold draft may occur at heating operation.

7.1.2. Refrigerant piping range

The piping selection and the distribution must be designed according to the following specifications:

i **NOTE:**

The liquid piping and the gas piping must be of the same length and run along the same route.

(*): When the first branch divides the installation into 2 parts or more and the length from the first branch to the farthest indoor unit is within 40 to 90 m, this parts must be equilibrated. The ratio of total indoor unit capacity after the first branch must be within 40-60%. If it's not possible, the length from first branch to the farthest indoor unit must be lower than 40 m.

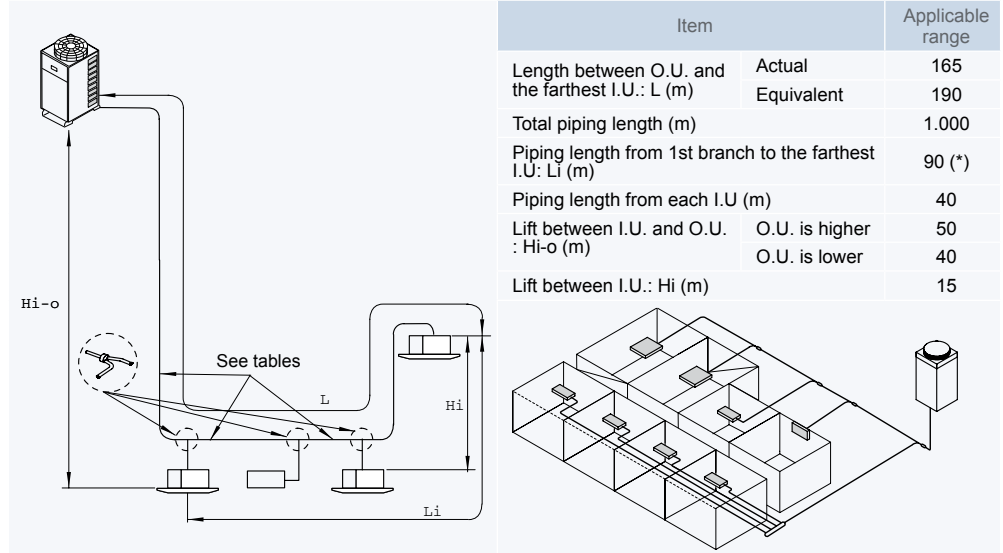

7.1.3. Refrigerant piping length by dip switch setting

The refrigerant piping length between indoor units and outdoor units must be designed using the following chart.

Maintain the design point within the dark area of the chart, which shows the height difference according to the piping length.

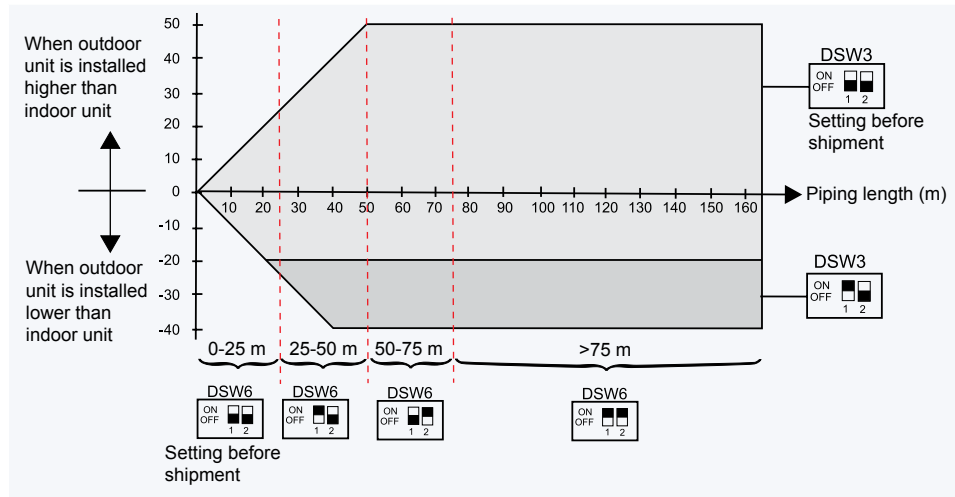

7.1.4. Piping size and multiple connections kit

In addition to the epoch-making "Uni-piping" system, where the same pipe size as the main refrigerant pipe can be used, the "Down-pipe" system is also available for piping cost reduction.

As shown in the following table, the "Uni-piping" system is not available for 12~48 HP units.

Unit	Piping systems	
	Uni-piping	Down-size
RAS-8/10FSN2	●	●
RAS-12~48FSN2	✗	●

i **NOTE:**

In case of Uni-piping system, the pipe size and the multi-kit from the outdoor unit to the last multi-kit is the same.

If the size of the multi-kit positioned after the 2nd kit is bigger than the 1st, use a kit of the same size as the 1st.

If the pipe size after the 1st branch is bigger than the pipe size between outdoor unit and the 1st kit, use the pipe of the same size as the 1st kit.

If you want to use "Unipiping" system for other configurations that are not shown in the table, consult with your distributor.

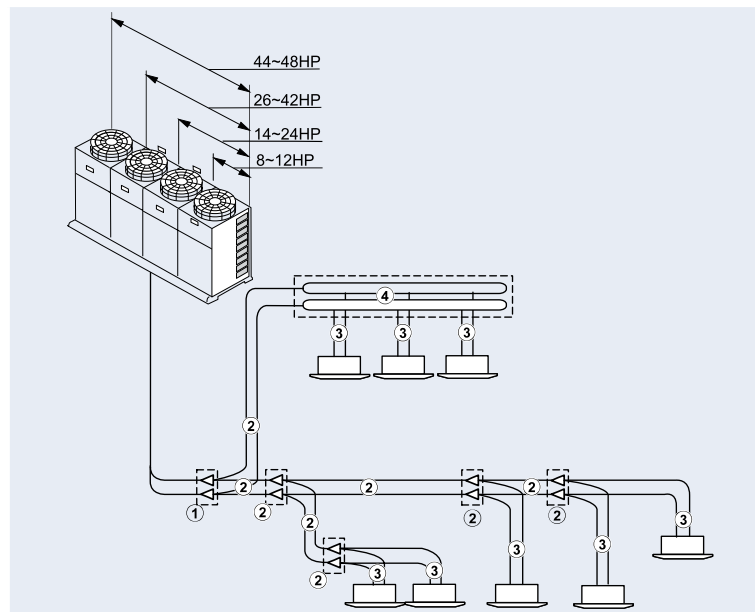

Table 1:

① **Outdoor unit to first multi-kit**

Unit	Pipe size (Ømm) (*)				Multi-kit
	Equivalent piping length < 100 m		Equivalent piping length > 100 m		
	Gas	Liquid	Gas	Liquid	
RAS-8FSN2	19.05~22.0	9.53~12.7	22.2	12.7	MW-102AN
RAS-10FSN2	22.2~25.4	9.53~12.7	25.4	12.7	MW-102AN
RAS-12FSN2	25.4~28.6	12.7~15.88	28.6	15.88	MW-162AN
RAS-14FSN2	25.4~28.6	12.7~15.88	28.6	15.88	MW-162AN
RAS-16FSN2	28.6~31.75	12.7~15.88	31.75	15.88	MW-162AN
RAS-18FSN2	28.6~31.75	15.88~19.05	31.75	19.05	MW-242AN
RAS-20FSN2	28.6~31.75	15.88~19.05	31.75	19.05	MW-242AN
RAS-22FSN2	28.6~31.75	15.88~19.05	31.75	19.05	MW-242AN
RAS-24FSN2	28.6~31.75	15.88~19.05	31.75	19.05	MW-242AN
RAS-26FSN2	31.75~34.9	19.05~22.2	34.9	22.2	MW-302AN
RAS-28FSN2	31.75~34.9	19.05~22.2	34.9	22.2	MW-302AN
RAS-30FSN2	31.75~34.9	19.05~22.2	34.9	22.2	MW-302AN
RAS-32FSN2	31.75~34.9	19.05~22.2	34.9	22.2	MW-302AN
RAS-34FSN2	31.75~34.9	19.05~22.2	34.9	22.2	MW-302AN
RAS-36FSN2	38.1~41.3	19.05~22.2	44.45	22.2	MW-302AN
RAS-38FSN2	38.1~41.3	19.05~22.2	44.45	22.2	MW-302AN
RAS-40FSN2	38.1~41.3	19.05~22.2	44.45	22.2	MW-302AN
RAS-42FSN2	38.1~41.3	19.05~22.2	44.45	22.2	MW-302AN
RAS-44FSN2	38.1~41.3	19.05~22.2	44.45	22.2	MW-302AN
RAS-46FSN2	38.1~41.3	19.05~22.2	44.45	22.2	MW-302AN
RAS-48FSN2	38.1~41.3	19.05~22.2	44.45	22.2	MW-302AN

i **NOTE:**

(*): When the equivalent refrigerant pipe length is over 100m, the pipe size of gas/liquid line from the outdoor unit to the first branch should be increased with the reducer (field-supplied).

 **Table 2:**



NOTE:

If the refrigerant piping length is more than 100m, no need to increase the pipe size after first branch.

If the multi-kit size is larger than the first branch, adjust the multi-kit size to the first branch. In case that the selected pipe size after the first branch is larger than the pipe size before the first branch, use the same pipe size as before the branch.

② **First multi-kit to last multi-kit**

Unit	Pipe size (Ømm)		Multi-kit
	Gas	Liquid	
36≤HP	38.1	19.05	MW-302AN
26≤HP<36	31.75	19.05	MW-302AN
18≤HP<26	28.6	15.88	MW-242AN
16≤HP<18	28.6	12.7	MW-162AN
12≤HP<16	25.4	12.7	MW-162AN
9≤HP<12	22.2	9.53	MW-102AN
6≤HP<9	19.05	9.53	MW-102AN
HP<6	15.88	9.53	MW-102AN

 **Table 3:**



NOTE:

The multi-kit pipe size should be the same that indoor unit pipe.

(*) When the liquid piping length is longer than 15 m, use Ø9.53 pipe and reducer (field supplied).

When the connecting pipe size at the indoor unit side is different, use the reducer (field supplied).

③ **Multi-kit to indoor unit**

Total indoor unit capacity (HP)	Pipe size (Ømm)		Maximum length of liquid pipe (m)
	Gas	Liquid	
0.8 to 2	12.7	6.35 (*)	15
2.5 to 6	15.88	9.53	40
8	19.05	9.53	40
10	22.2	9.53	40

 **Table 4:**

④ **Distributor system**

Total indoor unit capacity (HP)	Number of branches	Pipe size (Ømm)		Distributor
		Gas	Liquid	
5~8	4	15.88/19.05	9.53	MH-84AN
5~10	8	15.88/19.05/22.2	9.53	MH-108AN

7.2. Multi-kits and distributors

7.2.1. Size data

◆ Multi-kits

	Gas line	Reducer for gas line	Liquid line	Reducer for liquid line
MW-102AN	<p>(To main piping)</p> <p>(To outdoor unit)</p> <p>(To indoor unit)</p>	<p>Q'ty: 1</p>	<p>(To main piping)</p> <p>(To outdoor unit)</p> <p>(To indoor unit)</p>	<p>Q'ty: 2</p>
MW-162AN	<p>(To main piping)</p> <p>(To outdoor unit)</p> <p>(To indoor unit)</p>	<p>Q'ty: 1</p> <p>Q'ty: 1</p> <p>Q'ty: 1</p>	<p>(To main piping)</p> <p>(To outdoor unit)</p> <p>(To indoor unit)</p>	<p>Q'ty: 1</p>
MW-242AN	<p>(To main piping)</p> <p>(To outdoor unit)</p> <p>(To indoor unit)</p>	<p>Q'ty: 1</p> <p>Q'ty: 1</p> <p>Q'ty: 1</p>	<p>(To main piping)</p> <p>(To outdoor unit)</p> <p>(To indoor unit)</p>	<p>Q'ty: 1</p> <p>Q'ty: 1</p>
MW-302AN	<p>(To main piping)</p> <p>(To outdoor unit)</p> <p>(To indoor unit)</p>	<p>Q'ty: 1</p> <p>Q'ty: 1</p> <p>Q'ty: 1</p> <p>Q'ty: 2</p>	<p>(To main piping)</p> <p>(To outdoor unit)</p> <p>(To indoor unit)</p>	<p>Q'ty: 1</p> <p>Q'ty: 1</p> <p>Q'ty: 1</p>

◆ Distributors

	Gas line	Expander for gas line	Closing pipe for gas line	Liquid line	Expander for liquid line	Closing pipe for liquid line
MH-84AN		-	<p>Q'ty: 2</p>		<p>Q'ty: 4</p>	<p>Q'ty: 2</p>
MH-108AN		<p>Q'ty: 2</p>	<p>Q'ty: 6</p>		<p>Q'ty: 8</p>	<p>Q'ty: 6</p>

7.2.2. Distribution method

◆ **Line distribution**

With line distribution method, it is possible to make the first or the second main pipe distribution within the third branch. And do not make the main pipe distribution, at or after the fourth branch.

◆ **Branch method**

Branch method of piping length from the first branch to the farthest indoor unit ≤ 40 m.

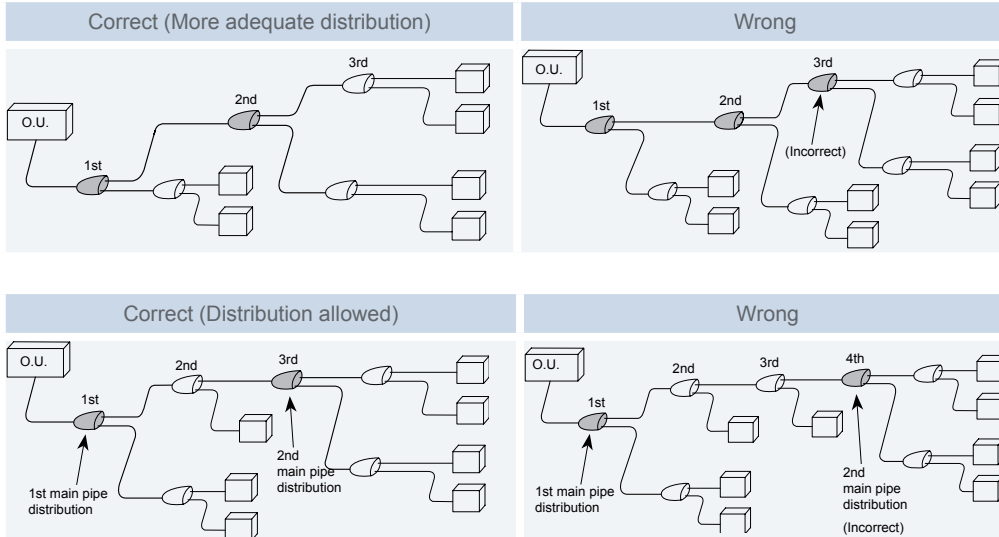

Branch method of piping length from the first branch to the farthest indoor unit 40~90 m.

- The number of piping branches at the line branch should be 1 portion.
- The total indoor unit capacity after the first branch should be within the ratio of 40% - 60%.
- Piping branch is 1 portion and the total indoor unit capacity after the first branch is within the ratio of 40% - 60%.

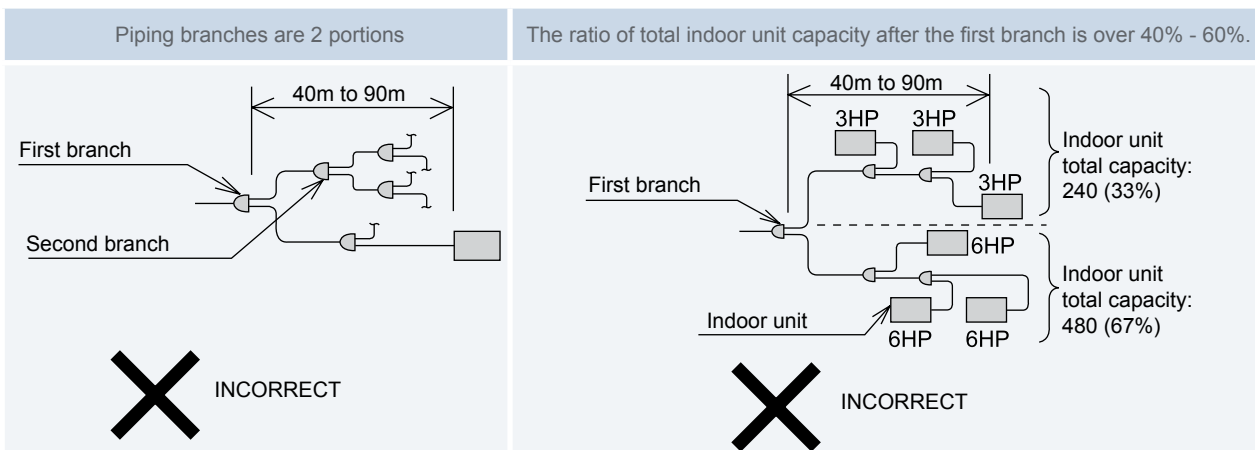
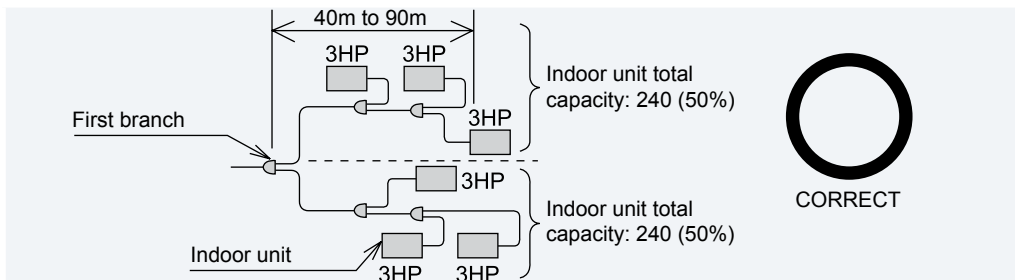

◆ Installation position

< Horizontal installation >

Locate the branch pipes on the same horizontal plane. (Inclination within 30°)
 Make the straight length a minimum of 0.5m after the vertical bend.

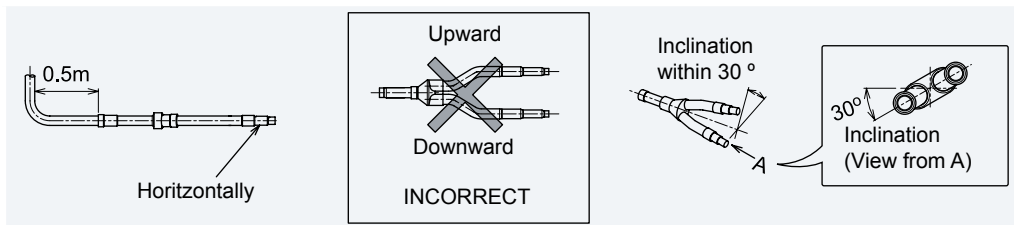

< Vertical installation >

Straight length of the pipe connection on the outdoor unit side is made as follows:

- * The collective pipe connection part is installed upward, the straight length must be min. 0.5m.
- * The collective pipe connection part is installed downward, the straight length must be min.0.3m.

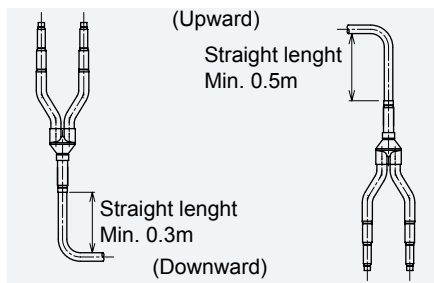

◆ Header distribution

◆ Branch method

Do not connect two header branches consecutively.

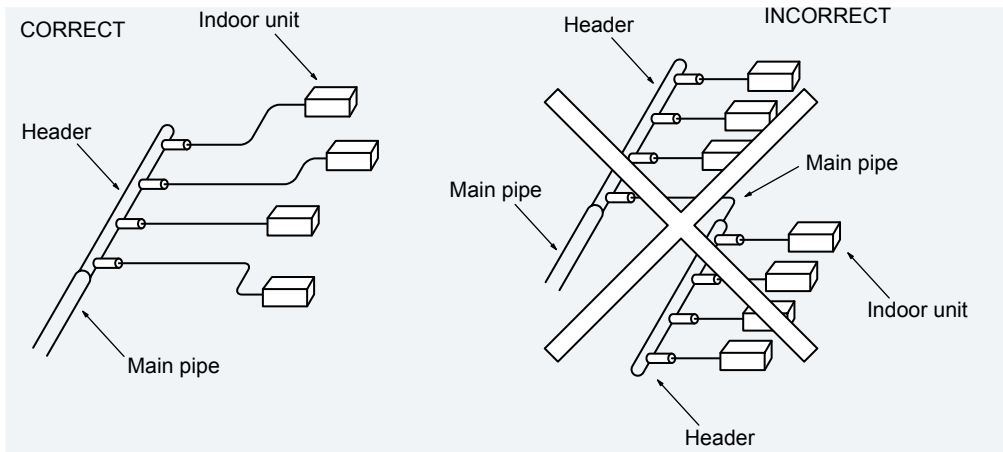

◆ Installation position

Perform to install horizontally always. (Ex.: In case of model MH-108AN)

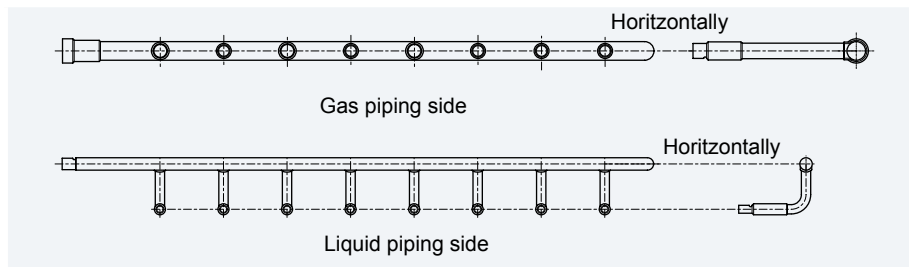

CAUTION:

Seal the end of branch pipes which are not connected, by brazing factory supplied closing pipes.

◆ Combination branch

- It is possible to connect the header to the second branch, when the first branch is also the line branch.
- Do not connect a line branch to a header branch.

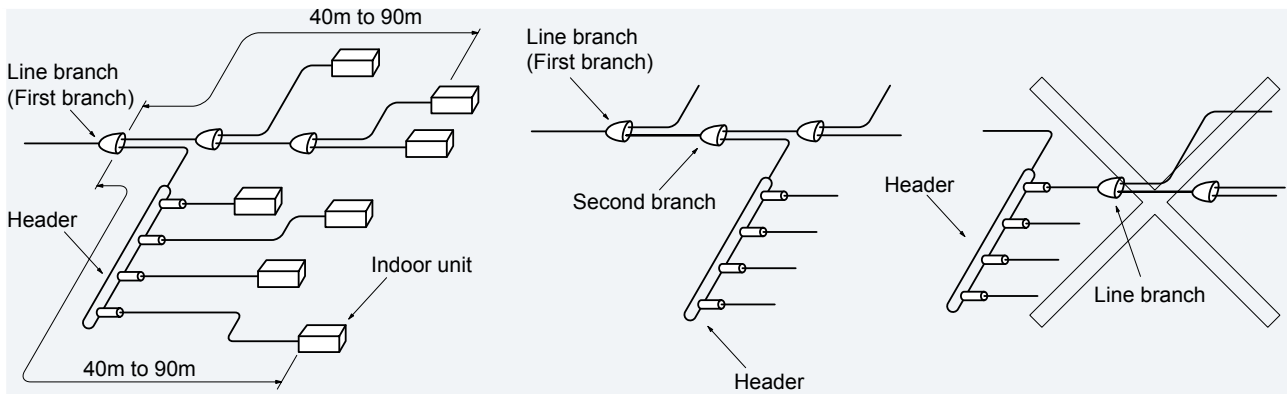

7.2.3. Copper pipes and sizes

1. Prepare locally-supplied copper pipes.
2. Select the pipe size of a suitable thickness and material. Use the table below to select the required piping.

Nominal diameter		Thickness (mm)	Copper type
(mm)	(in.)		
6.35	1/4	0.80	Rolled
9.53	3/8	0.80	Rolled
12.70	1/2	0.80	Rolled
15.88	5/8	1.00	Rolled
19.05	3/4	1.00	Piping
22.23	7/8	1.00	Piping
25.40	1	1.00	Piping
28.60	1-1/8	1.00	Piping
31.75	1-1/4	1.10	Piping
38.1	1-1/2	1.35	Piping
41.28	1-5/8	1.20	Piping
44.45	1-3/4	1.55	Piping

i **NOTE:**

If copper pipe is used for piping bigger than Ø19.05 flaring work can not be performed. If necessary, use a joint adapter.

▲ **CAUTION:**

- Do not use saws, grindstones or other tools which might create copper dust.
- When cutting pipes, secure the part for brazing in accordance to national and local regulations.
- Use security glasses and gloves for cutting or welding works.

3. Use clean copper pipes. Make sure there is no dust and moisture inside. Blow the inside of the pipes through with oxygen-free nitrogen to remove any dust and foreign materials before connecting pipes.
4. After connecting the refrigerant piping, seal the open space between the knockout hole and refrigerant pipes by using insulation material as shown below:

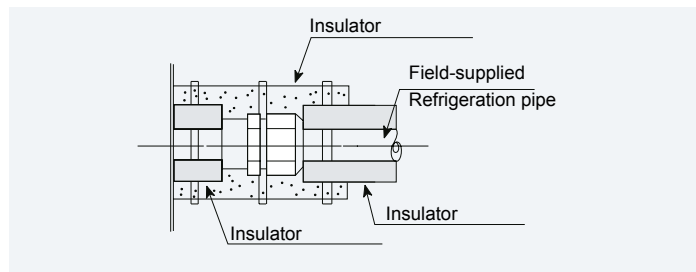

i NOTE:

- A system with no moisture or oil contamination will give maximum performance and life-cycle as compared with a poorly prepared system. Take particular care to ensure that all copper piping is clean and dry internally.
- To ensure this, blow oxygen-free nitrogen through the pipes.

CAUTION:

- Cap the end of the pipe when the pipe is to be inserted through a hole.
- Do not place pipes directly on the ground without a cap or vinyl tape covering the end, as it's shown in the right figures.
- If piping installation cannot be completed until the following day or longer, solder the ends of the piping closed and load with oxygen-free nitrogen using an access device such as a Schrader valve to avoid moisture and contamination by extraneous particles.
- Do not use insulation material that contains NH₃ because can damage copper pipe material and can be a source of future leakage.

i NOTE:

When polyethylene foam is applied, a thickness of 10mm for the liquid piping and 15mm to 20mm for the gas piping is recommended.

CAUTION:

Perform insulation work when the surface temperature reaches the room temperature. Otherwise it is possible that the insulation will melt.

If the ends of the piping system are open after accomplishing piping work, securely attach caps or vinyl bags to the ends of the piping, avoiding the invasion of moisture and dust.

◆ Piping connections

Fix the connecting pipe as shown in the following figure. Use the insulation attached to the indoor unit.

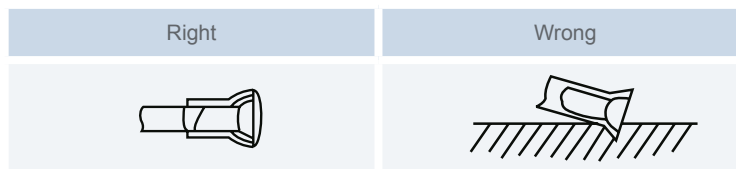
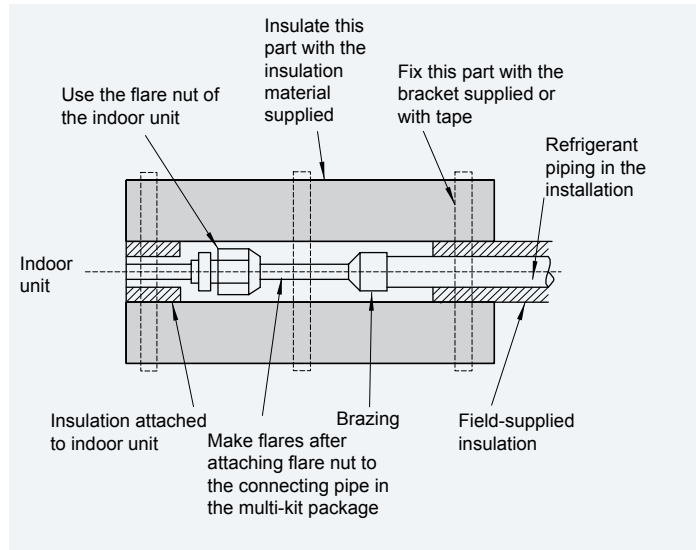

◆ Insulation

Attach insulation packet with multi-kit to each branch utilizing vinyl tape. Also attach insulation to field-supplied piping to prevent capacity decrease due to ambient air conditions and dewing on pipe surface caused by low pressure.

◆ Outdoor unit drain kit (DBS-26) (Optional accessory)

In the case that drain water from the heat exchanger of the outdoor unit is required to be collected, use the drain kit. However, it is not recommended to use it in a snow fall area.

If the drain water is required to be collected completely, provide a field-supplied drain pan under the outdoor unit.

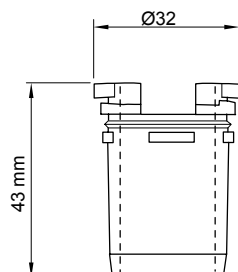

Outdoor unit HP	Drain kit quantity (units)
8 to 12 HP	DBS-26 x 4
14 to 24 HP	DBS-26 x 8
26 to 42 HP	DBS-26 x 12
44 to 48 HP	DBS-26 x 16

7.3. Amount refrigerant charge

7.3.1. Additional refrigerant charge calculation (R410A)

Although refrigerant has been charged into this unit, additional refrigerant charge is required according to piping length.

- The additional refrigerant quantity should be determined and charged into the system according to the following procedure.
- Record the additional refrigerant quantity in order to facilitate maintenance and servicing activities.

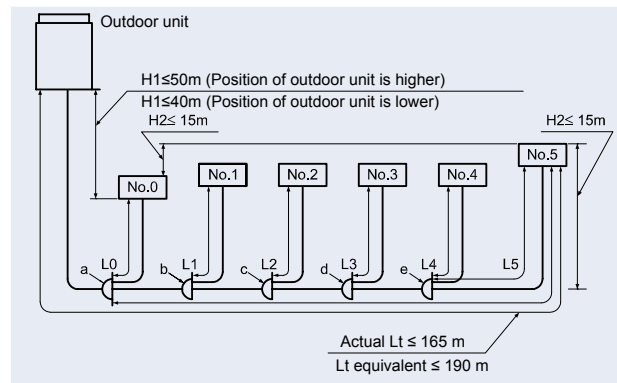

◆ Calculating method of additional refrigerant charge (W kg)

Calculate the additional refrigerant charge amount according to the following steps:

☛ Step 1:

Additional refrigerant charge calculation for liquid piping (W_1 (kg))

(Fill in the following table)

Pipe diameter (mm)	Total piping length (m)	Additional charge (kg/m)	Subtotal (kg)
Ø22.2		x 0.39	
Ø19.05		x 0.28	
Ø15.88		x 0.19	
Ø12.7		x 0.12	
Ø9.53		x 0.07	
Ø6.35		x 0.03	

☛ Step 2:

Additional refrigerant charge calculation for indoor unit (W_2 (kg))

When the outdoor unit is combined with indoor units RPI-8/10FSN2E, it's necessary an additional refrigerant charge (W_2) = 1 kg/unit.

For indoor units lower than 8 HP, the additional refrigerant charge it's not needed.

7

Step 3:

Calculation of total additional refrigerant charge (W (kg))

Put weight W_1 and W_2 calculated in step 1 and step 2 into the following formula:

Total additional refrigerant charge: $W = W_1 + W_2$

The following table shows the maximum additional refrigerant quantity allowed by unit.

Outdoor unit	Max. additional ref. charge quantity (kg)
RAS-8,10FSN2	28.0
RAS-12FSN2	36.0
RAS-14,16FSN2	40.0
RAS-18~24FSN2	51.0
RAS-26~48FSN2	63.0

- Charging work

Charge refrigerant (R410A) into the system according to the instructions described in "SMGB0049_rev0".

- Record of additional charge

The total refrigerant charge of this system is calculated with the following formula:

Total refrigerant charge: $W_{TOT} = W + W_0$

This system = + = kg

W_0 is the outdoor unit refrigerant charge before shipment, and it's shown in the following table:

Outdoor unit	W_0 outdoor unit refrigerant charge (kg)
RAS-8FSN2	10.0
RAS-10FSN2	10.5
RAS-12FSN2	11.0
RAS-14,16FSN2	18.0
RAS-18,20FSN2	19.5
RAS-22,24FSN2	20.0
RAS-26,28FSN2	27.0
RAS-30,32,34,36FSN2	28.5
RAS-38,40,42FSN2	30.0
RAS-44,46,48FSN2	35.0

Record the refrigerant charge quantity in order to facilitate maintenance and servicing activities.

Total additional charge W kg

Total Ref. charge kg

Date of ref. charge work
 / /



NOTE:

The total additional refrigerant charge quantity calculated, should not exceed the maximum additional refrigerant charge quantity allowed.

When the additional refrigerant charge is over the maximum additional refrigerant charge allowed by the unit, it's necessary to adjust the piping length of the installation.

7.3.2. Samples

◆ Total system of SET-FREE FSN2 series

ITEM		DISTRIBUTOR SYSTEM																									
Example of systems 1: Simple installation with distributor This figure shows examples of 6 indoor units combined with one outdoor unit. The refrigerant pipes are shown as single line in the diagrams. However, liquid line piping and gas line piping are required in the field.																											
Total piping length		≤ 1000 m																									
Maximum piping length	Actual length	Lt ≤ 165 m																									
	Equivalent length	Lt equivalent ≤ 190 m																									
Maximum lift between outdoor and indoor unit	In the case that the position of outdoor unit is higher than that of indoor unit.	H1 ≤ 50 m																									
	In the case that the position of outdoor unit is lower than that of indoor unit.	H1 ≤ 40 m																									
Maximum lift between each indoor unit. or Multi-kit and indoor unit		H2 ≤ 15 m																									
Maximum piping length between Multi-kit and indoor unit	Between the "a" kit and the farthest indoor unit	L ≤ 90 m																									
	Between each Multi-kit and each indoor unit	L0. L1. L2. L3. L4. L5 ≤ 40 m																									
Example: Outdoor unit: RAS-8FSN2																											
Selecting the distributor.		Use MH-108AN (8 branches)																									
1) Additional refrigerant charge quantity The quantity is calculated by the following equation: $W \text{ (kg)} = W_{11} + W_{12} + W_{13} + W_{14} + W_{15} + W_{16} + W_2$		1.1) Liquid piping	Example: <table border="1"> <thead> <tr> <th>Mark</th> <th>Lt-L5</th> <th>L0</th> <th>L1</th> <th>L2</th> <th>L3</th> <th>L4</th> <th>L5</th> </tr> </thead> <tbody> <tr> <td>Size</td> <td>Ø9.53</td> <td>Ø6.35</td> <td>Ø6.35</td> <td>Ø6.35</td> <td>Ø6.35</td> <td>Ø6.35</td> <td>Ø6.35</td> </tr> <tr> <td>Length</td> <td>61</td> <td>5</td> <td>3</td> <td>5</td> <td>3</td> <td>3</td> <td>5</td> </tr> </tbody> </table> $W_{15} = 61 \times 0.07 = 4.27 \text{ kg}$ $W_{16} = (5+3+5+3+5+3) \times 0.03 = 0.72 \text{ kg}$	Mark	Lt-L5	L0	L1	L2	L3	L4	L5	Size	Ø9.53	Ø6.35	Ø6.35	Ø6.35	Ø6.35	Ø6.35	Ø6.35	Length	61	5	3	5	3	3	5
Mark	Lt-L5		L0	L1	L2	L3	L4	L5																			
Size	Ø9.53	Ø6.35	Ø6.35	Ø6.35	Ø6.35	Ø6.35	Ø6.35																				
Length	61	5	3	5	3	3	5																				
1.1) W_{11} (kg): (Total length (m) of Ø22.2 Liquid piping) x 0.39 1.2) W_{12} (kg): (Total length (m) of Ø19.05 Liquid piping) x 0.28 1.3) W_{13} (kg): (Total length (m) of Ø15.88 Liquid piping) x 0.19 1.4) W_{14} (kg): (Total length (m) of Ø12.7 Liquid piping) x 0.12 1.5) W_{15} (kg): (Total length (m) of Ø9.53 Liquid piping) x 0.07 1.6) W_{16} (kg): (Total length (m) of Ø6.35 Liquid piping) x 0.030		1.2) Indoor unit	Example: <table border="1"> <thead> <tr> <th>Indoor Unit No.</th> <th>0</th> <th>1</th> <th>2</th> <th>3</th> <th>4</th> <th>5</th> </tr> </thead> <tbody> <tr> <td>Corresponding power (HP)</td> <td>1.5</td> <td>1.5</td> <td>1</td> <td>1</td> <td>1.5</td> <td>1.5</td> </tr> <tr> <td>Additional refrigerant quantity</td> <td colspan="6">Indoor units that do not require refrigerant charge</td> </tr> </tbody> </table> $W_2 = 0 \text{ kg}$	Indoor Unit No.	0	1	2	3	4	5	Corresponding power (HP)	1.5	1.5	1	1	1.5	1.5	Additional refrigerant quantity	Indoor units that do not require refrigerant charge								
Indoor Unit No.	0		1	2	3	4	5																				
Corresponding power (HP)	1.5	1.5	1	1	1.5	1.5																					
Additional refrigerant quantity	Indoor units that do not require refrigerant charge																										
1.2) W_2 (kg): Total quantity of additional refrigerant of each indoor unit (kg)		Total	$W \text{ (kg)} = W_{11} + W_{12} + W_{13} + W_{14} + W_{15} + W_{16} + W_2$ $= 0 + 0 + 0 + 0 + 4.27 + 0.72 + 0 = 4.99 \text{ kg}$																								
2) Checking the maximum quantity of additional refrigerant charge: ($W < W_{MAX}$)		4.99 kg < 28 kg (CORRECT)																									
3) Total refrigerant charge: $W_{TOT} \text{ (kg)} = W_0 + W$ W_0 : Outdoor unit refrigerant charge before shipment (kg)		$W_{TOT} = 10.0 + 4.99 = 14.99 \text{ kg}$																									

NOTES:

- Refer to "Refrigerant piping work" to know all the information necessary for the calculation of the additional refrigerant charge.
- Refer to "Additional refrigerant charge calculation" in this chapter to know the maximum quantity of additional refrigerant charge (W_{MAX}) and the outdoor unit refrigerant charge before shipment (W_0).

ITEM	MULTI-KITS UNI-PIPING SYSTEM	
<p>Example of systems</p> <p>2: Simple installation with multi-kits (Uni-piping)</p> <p>This figure shows examples of 6 indoor units combined with one outdoor unit.</p> <p>The refrigerant pipes are shown as a single line in the diagrams. However, liquid line piping and gas line piping are required in the field.</p>		
Total piping length	≤ 1000 m	
Maximum piping length	Actual length	Lt ≤ 165 m
	Equivalent length	Lt ≤ 190 m
Maximum lift between outdoor and indoor unit	In the case that the position of outdoor unit is higher than that of indoor unit.	H1 ≤ 50 m
	In the case that the position of outdoor unit is lower than that of indoor unit.	H1 ≤ 40 m
Maximum lift between each indoor unit, or multi-kit and indoor unit	H2 ≤ 15 m	
Maximum piping length between multi-kit and indoor unit	Between the "a" kit and the farthest indoor unit	L ≤ 90 m
	Between each multi-kit and each indoor unit	L0, L1, L2, L3, L4, L5 ≤ 40 m

Example: Outdoor unit: RAS-10FSN2

Choice of each multi-kit	<table border="1"> <tr> <td>Mark</td> <td>a,b,c,d,e</td> </tr> <tr> <td>Multi-kit</td> <td>MW-102AN</td> </tr> </table>	Mark	a,b,c,d,e	Multi-kit	MW-102AN																				
Mark	a,b,c,d,e																								
Multi-kit	MW-102AN																								
<p>1) Additional refrigerant charge quantity</p> <p>The quantity is calculated by the following equation:</p> $W \text{ (kg)} = W_{11} + W_{12} + W_{13} + W_{14} + W_{15} + W_{16} + W_2$	<p>Example:</p> <table border="1"> <thead> <tr> <th>Mark</th> <th>Lt-L5</th> <th>L0</th> <th>L1</th> <th>L2</th> <th>L3</th> <th>L4</th> <th>L5</th> </tr> </thead> <tbody> <tr> <td>Size</td> <td>Ø9.53</td> <td>Ø6.35</td> <td>Ø6.35</td> <td>Ø6.35</td> <td>Ø6.35</td> <td>Ø6.35</td> <td>Ø6.35</td> </tr> <tr> <td>Length</td> <td>60</td> <td>5</td> <td>3</td> <td>5</td> <td>3</td> <td>5</td> <td>3</td> </tr> </tbody> </table> $W_{15} = 60 \times 0.07 = 4.2 \text{ kg}$ $W_{16} = (5+3+5+3+5+3) \times 0.03 = 0.72 \text{ kg}$	Mark	Lt-L5	L0	L1	L2	L3	L4	L5	Size	Ø9.53	Ø6.35	Ø6.35	Ø6.35	Ø6.35	Ø6.35	Ø6.35	Length	60	5	3	5	3	5	3
Mark	Lt-L5	L0	L1	L2	L3	L4	L5																		
Size	Ø9.53	Ø6.35	Ø6.35	Ø6.35	Ø6.35	Ø6.35	Ø6.35																		
Length	60	5	3	5	3	5	3																		
<p>1.1) Liquid piping</p> <p>1.1) W_{11} (kg): (Total length (m) of Ø22.2 Liquid piping) x 0.39</p> <p>W_{12} (kg): (Total length (m) of Ø19.05 Liquid piping) x 0.28</p> <p>W_{13} (kg): (Total length (m) of Ø15.88 Liquid piping) x 0.19</p> <p>W_{14} (kg): (Total length (m) of Ø12.7 Liquid piping) x 0.12</p> <p>W_{15} (kg): (Total length (m) of Ø9.53 Liquid piping) x 0.07</p> <p>W_{16} (kg): (Total length (m) of Ø6.35 Liquid piping) x 0.030</p>	<p>1.2) Indoor unit</p> <p>Example:</p> <table border="1"> <thead> <tr> <th>Indoor Unit No.</th> <th>0</th> <th>1</th> <th>2</th> <th>3</th> <th>4</th> <th>5</th> </tr> </thead> <tbody> <tr> <td>Corresponding power (HP)</td> <td>1</td> <td>1</td> <td>2</td> <td>2</td> <td>2</td> <td>2</td> </tr> <tr> <td>Additional refrigerant quantity</td> <td colspan="6">Indoor units that do not require ref. charge</td> </tr> </tbody> </table> $W_2 = 0 \text{ kg}$	Indoor Unit No.	0	1	2	3	4	5	Corresponding power (HP)	1	1	2	2	2	2	Additional refrigerant quantity	Indoor units that do not require ref. charge								
Indoor Unit No.	0	1	2	3	4	5																			
Corresponding power (HP)	1	1	2	2	2	2																			
Additional refrigerant quantity	Indoor units that do not require ref. charge																								
<p>1.2) W_2 (kg): Total quantity of additional refrigerant of each indoor unit (kg)</p> <p>Total</p>	$W \text{ (kg)} = W_{11} + W_{12} + W_{13} + W_{14} + W_{15} + W_{16} + W_2$ $= 0 + 0 + 0 + 0 + 4.2 + 0.72 + 0 = 4.92 \text{ kg}$																								
<p>2) Checking the maximum quantity of additional refrigerant charge: ($W < W_{MAX}$)</p>	4.92 kg < 28 kg (CORRECT)																								
<p>3) Total refrigerant charge: $W_{TOT} \text{ (kg)} = W_0 + W$</p> <p>$W_0$: Outdoor unit refrigerant charge before shipment (kg)</p>	$W_{TOT} = 10.5 + 4.92 = 15.42 \text{ kg}$																								

NOTES:

- Refer to "Refrigerant piping work" to know all the information necessary for the calculation of the additional refrigerant charge.
- Refer to "Additional refrigerant charge calculation" in this chapter to know the maximum quantity of additional refrigerant charge (W_{MAX}) and the outdoor unit refrigerant charge before shipment (W_0).

ITEM		MULTI-KITS DOWN-SIZE SYSTEM																																																	
<p>Example of systems</p> <p>3: Simple installation with multi-kits (Down-size)</p> <p>This figure shows examples of 6 indoor units combined with one outdoor unit.</p> <p>The refrigerant pipes are shown as a single line in the diagrams. However, liquid line piping and gas line piping are required in the field.</p>																																																			
Total piping length		≤ 1000 m																																																	
Maximum piping length	Actual length	Lt ≤ 165 m																																																	
	Equivalent length	Lt ≤ 190 m																																																	
Maximum lift between outdoor and indoor unit	In the case that the position of outdoor unit is higher than that of indoor unit.	H1 ≤ 50 m																																																	
	In the case that the position of outdoor unit is lower than that of indoor unit.	H1 ≤ 40 m																																																	
Maximum lift between each indoor unit, or multi-kit and indoor unit		H2 ≤ 15 m																																																	
Maximum piping length between multi-kit and indoor unit		L ≤ 90 m																																																	
Between each multi-kit and each indoor unit		L0, L1, L2, L3, L4, L5 ≤ 40 m																																																	
Example: Outdoor unit: RAS-12FSN2																																																			
Choice of each multi-kit		<table border="1"> <tr> <th>Mark</th> <th>a</th> <th>b,c,d,e</th> </tr> <tr> <td>Multi-kit</td> <td>MW-162AN</td> <td>MW-102AN</td> </tr> </table>	Mark	a	b,c,d,e	Multi-kit	MW-162AN	MW-102AN																																											
Mark	a	b,c,d,e																																																	
Multi-kit	MW-162AN	MW-102AN																																																	
<p>1) Additional refrigerant charge quantity</p> <p>The quantity is calculated by the following equation:</p> $W \text{ (kg)} = W_{11} + W_{12} + W_{13} + W_{14} + W_{15} + W_{16} + W_2$		<p>Example:</p> <table border="1"> <thead> <tr> <th>Mark</th> <th>LM1</th> <th>LM2</th> <th>L0</th> <th>L1</th> <th>L2</th> <th>L3</th> <th>L4</th> <th>L5</th> </tr> </thead> <tbody> <tr> <td>Size</td> <td>Ø12.7</td> <td>Ø9.53</td> <td>Ø6.35</td> <td>Ø6.35</td> <td>Ø6.35</td> <td>Ø6.35</td> <td>Ø6.35</td> <td>Ø6.35</td> </tr> <tr> <td>Length</td> <td>45</td> <td>20</td> <td>5</td> <td>3</td> <td>5</td> <td>3</td> <td>5</td> <td>3</td> </tr> </tbody> </table> $W_{14} = 45 \times 0.12 = 5.4 \text{ kg}$ $W_{15} = 20 \times 0.07 = 1.4 \text{ kg}$ $W_{16} = (5+3+5+3+5+3) \times 0.03 = 0.72 \text{ kg}$	Mark	LM1	LM2	L0	L1	L2	L3	L4	L5	Size	Ø12.7	Ø9.53	Ø6.35	Ø6.35	Ø6.35	Ø6.35	Ø6.35	Ø6.35	Length	45	20	5	3	5	3	5	3	<p>Example:</p> <table border="1"> <thead> <tr> <th>Indoor Unit No.</th> <th>0</th> <th>1</th> <th>2</th> <th>3</th> <th>4</th> <th>5</th> </tr> </thead> <tbody> <tr> <td>Corresponding power (HP)</td> <td>2</td> <td>2</td> <td>2</td> <td>2</td> <td>2</td> <td>2</td> </tr> <tr> <td>Additional refrigerant quantity</td> <td colspan="6">Indoor units that do not require ref. charge</td> </tr> </tbody> </table> $W_2 = 0 \text{ kg}$	Indoor Unit No.	0	1	2	3	4	5	Corresponding power (HP)	2	2	2	2	2	2	Additional refrigerant quantity	Indoor units that do not require ref. charge					
Mark	LM1		LM2	L0	L1	L2	L3	L4	L5																																										
Size	Ø12.7		Ø9.53	Ø6.35	Ø6.35	Ø6.35	Ø6.35	Ø6.35	Ø6.35																																										
Length	45		20	5	3	5	3	5	3																																										
Indoor Unit No.	0		1	2	3	4	5																																												
Corresponding power (HP)	2		2	2	2	2	2																																												
Additional refrigerant quantity	Indoor units that do not require ref. charge																																																		
1.1) Liquid piping																																																			
1.2) Indoor unit																																																			
Total		$W \text{ (kg)} = W_{11} + W_{12} + W_{13} + W_{14} + W_{15} + W_{16} + W_2$ $= 0 + 0 + 0 + 5.4 + 1.4 + 0.72 + 0 = 7.52 \text{ kg}$																																																	
1.2) W ₂ (kg): Total quantity of additional refrigerant of each indoor unit (kg)																																																			
2) Checking the maximum quantity of additional refrigerant charge: (W < W _{MAX})		7.52 kg < 36 kg (CORRECT)																																																	
3) Total refrigerant charge: W _{TOT} (kg) = W ₀ + W W ₀ : Outdoor unit refrigerant charge before shipment (kg)		W _{TOT} = 11.0 + 7.52 = 18.52 kg																																																	

7

NOTES:

- Refer to "Refrigerant piping work" to know all the information necessary for the calculation of the additional refrigerant charge.
- Refer to "Additional refrigerant charge calculation" in this chapter to know the maximum quantity of additional refrigerant charge (W_{MAX}) and the outdoor unit refrigerant charge before shipment (W₀).

ITEM	MULTI-KITS DOWN-SIZE SYSTEM																															
<p>Example of systems</p> <p>4: Simple installation where the length from the outdoor unit to the first branch is over 100 m (Down-size)</p> <p>This figure shows examples of 6 indoor units combined with one outdoor unit.</p> <p>The refrigerant pipes are shown as a single line in the diagrams. However, liquid line piping and gas line piping are required in the field.</p>																																
Total piping length	≤ 1000 m																															
Maximum piping length	Actual length	Lt ≤ 165 m																														
	Equivalent length	Lt ≤ 190 m																														
Maximum lift between outdoor and indoor unit	In the case that the position of outdoor unit is higher than that of indoor unit.	H1 ≤ 50 m																														
	In the case that the position of outdoor unit is lower than that of indoor unit.	H1 ≤ 40 m																														
Maximum lift between each indoor unit, or Multi-kit and indoor unit	H2 ≤ 15 m																															
Maximum piping length between Multi-kit and indoor unit	Between the "a" kit and the farthest indoor unit	L ≤ 90 m																														
	Between each Multi-kit and each indoor unit	L0, L1, L2, L3, L4, L5 ≤ 40 m																														
Example: Outdoor unit: RAS-14FSN2																																
Choice of each multi-kit	<table border="1" style="width: 100%;"> <thead> <tr> <th>Mark</th> <th>a,b</th> <th>c,d,e</th> </tr> </thead> <tbody> <tr> <td>Multi-kit</td> <td>MW-162AN</td> <td>MW-102AN</td> </tr> </tbody> </table>		Mark	a,b	c,d,e	Multi-kit	MW-162AN	MW-102AN																								
Mark	a,b	c,d,e																														
Multi-kit	MW-162AN	MW-102AN																														
<p>1) Additional refrigerant charge quantity</p> <p>The quantity is calculated by the following equation:</p> $W \text{ (kg)} = W_{11} + W_{12} + W_{13} + W_{14} + W_{15} + W_{16} + W_2$	<p>1.1) Liquid piping</p>	<p>Example:</p> <table border="1" style="width: 100%;"> <thead> <tr> <th>Mark</th> <th>LM1</th> <th>LM2</th> <th>LM3</th> <th>L0</th> <th>L1</th> <th>L2</th> <th>L3</th> <th>L4</th> <th>L5</th> </tr> </thead> <tbody> <tr> <td>Size</td> <td>Ø15.88 (*1)</td> <td>Ø12.7</td> <td>Ø9.53</td> <td>Ø6.35</td> <td>Ø9.53</td> <td>Ø9.53</td> <td>Ø6.35</td> <td>Ø9.53</td> <td>Ø9.53</td> </tr> <tr> <td>Length</td> <td>111</td> <td>5</td> <td>15</td> <td>5</td> <td>3</td> <td>5</td> <td>3</td> <td>5</td> <td>3</td> </tr> </tbody> </table> <p> $W_{13} = 111 \times 0.19 = 21.09 \text{ kg}$ $W_{14} = 5 \times 0.12 = 0.6 \text{ kg}$ $W_{15} = (15+3+5+5+3) \times 0.07 = 2.17 \text{ kg}$ $W_{16} = (5+3) \times 0.03 = 0.24 \text{ kg}$ </p>	Mark	LM1	LM2	LM3	L0	L1	L2	L3	L4	L5	Size	Ø15.88 (*1)	Ø12.7	Ø9.53	Ø6.35	Ø9.53	Ø9.53	Ø6.35	Ø9.53	Ø9.53	Length	111	5	15	5	3	5	3	5	3
Mark		LM1	LM2	LM3	L0	L1	L2	L3	L4	L5																						
Size	Ø15.88 (*1)	Ø12.7	Ø9.53	Ø6.35	Ø9.53	Ø9.53	Ø6.35	Ø9.53	Ø9.53																							
Length	111	5	15	5	3	5	3	5	3																							
<p>1.1) W_{11} (kg): (Total length (m) of Ø22.2 Liquid piping) x 0.39</p> <p>1.2) W_{12} (kg): (Total length (m) of Ø19.05 Liquid piping) x 0.28</p> <p>1.3) W_{13} (kg): (Total length (m) of Ø15.88 Liquid piping) x 0.19</p> <p>1.4) W_{14} (kg): (Total length (m) of Ø12.7 Liquid piping) x 0.12</p> <p>1.5) W_{15} (kg): (Total length (m) of Ø9.53 Liquid piping) x 0.07</p> <p>1.6) W_{16} (kg): (Total length (m) of Ø6.35 Liquid piping) x 0.030</p>	<p>1.2) Indoor unit</p>	<p>Example:</p> <table border="1" style="width: 100%;"> <thead> <tr> <th>Indoor Unit No.</th> <th>0</th> <th>1</th> <th>2</th> <th>3</th> <th>4</th> <th>5</th> </tr> </thead> <tbody> <tr> <td>Corresponding power (HP)</td> <td>2</td> <td>2.5</td> <td>2.5</td> <td>2</td> <td>2.5</td> <td>2.5</td> </tr> <tr> <td>Additional refrigerant quantity</td> <td colspan="6">Indoor units that do not require ref. charge</td> </tr> </tbody> </table> <p>$W_2 = 0 \text{ kg}$</p>	Indoor Unit No.	0	1	2	3	4	5	Corresponding power (HP)	2	2.5	2.5	2	2.5	2.5	Additional refrigerant quantity	Indoor units that do not require ref. charge														
Indoor Unit No.	0	1	2	3	4	5																										
Corresponding power (HP)	2	2.5	2.5	2	2.5	2.5																										
Additional refrigerant quantity	Indoor units that do not require ref. charge																															
<p>1.2) W_2 (kg): Total quantity of additional refrigerant of each indoor unit (kg)</p>	Total	<p>$W \text{ (kg)} = W_{11} + W_{12} + W_{13} + W_{14} + W_{15} + W_{16} + W_2$</p> <p>$= 0 + 0 + 21.09 + 0.6 + 2.17 + 0.24 + 0 = 24.1 \text{ kg}$</p>																														
<p>2) Checking the maximum quantity of additional refrigerant charge: ($W < W_{MAX}$)</p>	24.1 kg < 40 kg (CORRECT)																															
<p>3) Total refrigerant charge: $W_{TOT} \text{ (kg)} = W_0 + W$</p> <p>$W_0$: Outdoor unit refrigerant charge before shipment (kg)</p>	$W_{TOT} = 18.0 + 24.1 = 42.1 \text{ kg}$																															

NOTES:

- Refer to "Refrigerant piping work" to know all the information necessary for the calculation of the additional refrigerant charge.
- Refer to "Additional refrigerant charge calculation" in this chapter to know the maximum quantity of additional refrigerant charge (W_{MAX}) and the outdoor unit refrigerant charge before shipment (W_0).
- (*1): When the equivalent refrigerant piping length is over 100 m (111 m in this example), the pipe size of the line from the outdoor unit to the first branch should be increased with the reducer (field supplied). In this case (RAS-14FSN2), the pipe is increased from Ø12.7 to Ø15.88.

ITEM		DOWN-SIZE DISTRIBUTOR AND MULTI-KITS SYSTEM WITH REDUCTION
Example of systems		
<p>5: Line distribution method where is needed an additional refrigerant charge for indoor unit. The length from the first branch to the farthest indoor unit is not over 40 m. (Down-size)</p> <p>This figure shows examples of 6 indoor units combined with one outdoor unit.</p> <p>The refrigerant pipes are shown as a single line in the diagrams. However, liquid line piping and gas line piping are required in the field.</p>		
Total piping length		≤ 1000 m
Maximum piping length	Actual length	Lt ≤ 165 m
	Equivalent length	Lt ≤ 190 m
Maximum lift between outdoor and indoor unit	In the case that the position of outdoor unit is higher than that of indoor unit.	H1 ≤ 50 m
	In the case that the position of outdoor unit is lower than that of indoor unit.	H1 ≤ 40 m
Maximum lift between each indoor unit. or Multi-kit and indoor unit		H2 ≤ 15 m
Maximum piping length between Multi-kit and indoor unit	Between the "a" kit and the farthest indoor unit	L ≤ 90 m (*1)
	Between each Multi-kit and each indoor unit	L0. L1. L2. L3. L4. L5 ≤ 40 m

Example: Outdoor unit: RAS-24FSN2

Choice of each multi-kit	Mark	a	b,c	d
	Multi-kit	MW-242AN	MW-162AN	MH-84HAN

<p>1) Additional refrigerant charge quantity</p> <p>The quantity is calculated by the following equation: $W \text{ (kg)} = W_{11} + W_{12} + W_{13} + W_{14} + W_{15} + W_{16} + W_2$</p> <p>1.1) W_{11} (kg): (Total length (m) of $\varnothing 22.2$ Liquid piping) x 0.39</p> <p>W_{12} (kg): (Total length (m) of $\varnothing 19.05$ Liquid piping) x 0.28</p> <p>W_{13} (kg): (Total length (m) of $\varnothing 15.88$ Liquid piping) x 0.19</p> <p>W_{14} (kg): (Total length (m) of $\varnothing 12.7$ Liquid piping) x 0.12</p> <p>W_{15} (kg): (Total length (m) of $\varnothing 9.53$ Liquid piping) x 0.07</p> <p>W_{16} (kg): (Total length (m) of $\varnothing 6.35$ Liquid piping) x 0.030</p> <p>1.2) W_2 (kg): Total quantity of additional refrigerant of each indoor unit (kg)</p>	1.1) Liquid piping	<p>Example:</p> <table border="1"> <thead> <tr> <th>Mark</th> <th>LM1</th> <th>LM2</th> <th>LM3</th> <th>L0</th> <th>L1</th> <th>L2</th> <th>L3</th> <th>L4</th> <th>L5</th> </tr> </thead> <tbody> <tr> <td>Size</td> <td>$\varnothing 15.88$</td> <td>$\varnothing 12.7$</td> <td>$\varnothing 9.53$</td> <td>$\varnothing 9.53$</td> <td>$\varnothing 9.53$</td> <td>$\varnothing 9.53$</td> <td>$\varnothing 9.53$</td> <td>$\varnothing 6.35$</td> <td>$\varnothing 9.53$</td> </tr> <tr> <td>Length</td> <td>50</td> <td>20</td> <td>20</td> <td>10</td> <td>8</td> <td>16</td> <td>7</td> <td>12</td> <td>10</td> </tr> </tbody> </table> <p>$W_{13} = 50 \times 0.19 = 9.5 \text{ kg}$; $W_{15} = (10+20+10+14+20) \times 0.07 = 5.18 \text{ kg}$ $W_{14} = 20 \times 0.12 = 2.4 \text{ kg}$; $W_{16} = (7+12+10) \times 0.03 = 0.87 \text{ kg}$</p>	Mark	LM1	LM2	LM3	L0	L1	L2	L3	L4	L5	Size	$\varnothing 15.88$	$\varnothing 12.7$	$\varnothing 9.53$	$\varnothing 9.53$	$\varnothing 9.53$	$\varnothing 9.53$	$\varnothing 9.53$	$\varnothing 6.35$	$\varnothing 9.53$	Length	50	20	20	10	8	16	7	12	10
	Mark	LM1	LM2	LM3	L0	L1	L2	L3	L4	L5																						
	Size	$\varnothing 15.88$	$\varnothing 12.7$	$\varnothing 9.53$	$\varnothing 9.53$	$\varnothing 9.53$	$\varnothing 9.53$	$\varnothing 9.53$	$\varnothing 6.35$	$\varnothing 9.53$																						
	Length	50	20	20	10	8	16	7	12	10																						
		1.2) Indoor unit	<p>Example:</p> <table border="1"> <thead> <tr> <th>Indoor Unit No..</th> <th>0</th> <th>1</th> <th>2</th> <th>3</th> <th>4</th> <th>5</th> </tr> </thead> <tbody> <tr> <td>Corresponding power (HP)</td> <td>4</td> <td>4</td> <td>8 (*2)</td> <td>3</td> <td>2</td> <td>3</td> </tr> <tr> <td>Additional refrigerant quantity</td> <td colspan="6">Indoor unit N°2: 1 kg</td> </tr> </tbody> </table> <p>$W_2 = 1 \text{ kg}$</p>	Indoor Unit No..	0	1	2	3	4	5	Corresponding power (HP)	4	4	8 (*2)	3	2	3	Additional refrigerant quantity	Indoor unit N°2: 1 kg													
	Indoor Unit No..	0	1	2	3	4	5																									
Corresponding power (HP)	4	4	8 (*2)	3	2	3																										
Additional refrigerant quantity	Indoor unit N°2: 1 kg																															
	Total	<p>$W \text{ (kg)} = W_{11} + W_{12} + W_{13} + W_{14} + W_{15} + W_{16} + W_2$ $= 0 + 0 + 9.5 + 2.4 + 4.97 + 0.36 + 1 = 18.23 \text{ kg}$</p>																														
2) Checking the maximum quantity of additional refrigerant charge: ($W < W_{MAX}$)		18.23 kg < 51 kg (CORRECT)																														

3) Total refrigerant charge: $W_{TOT} \text{ (kg)} = W_0 + W$ W_0 : Outdoor unit refrigerant charge before shipment (kg)	$W_{TOT} = 20.0 + 18.23 = 38.23 \text{ kg}$
---	---

- NOTES:**
- Refer to "Refrigerant piping work" to know all the information necessary for the calculation of the additional refrigerant charge.
 - Refer to "Additional refrigerant charge calculation" in this chapter to know the maximum quantity of additional refrigerant charge (W_{MAX}) and the outdoor unit refrigerant charge before shipment (W_0).
 - (*1): When the first branch divides the installation into 2 parts and the length from first branch to the farthest indoor unit is within 40 to 90 m, this parts must be equilibrated. The ratio of total indoor unit capacity after the first branch must be within 40-60%. In this example we have this installation type. Therefore, it's necessary to check the piping length and the indoor unit capacity at the 2 parts:
 - a) From a to indoor unit n°4 (Length: (20+12)) = 32 m; (3+2+3)/24 = 0.33 (33%). This case is CORRECT because the piping length is not over 40 m.
 - b) From a to indoor unit n°2 (Length: (20+16)) = 36 m; (4+4+8)/24 = 0.67 (67%). This case is CORRECT because the piping length is not over 40 m.
 - (*2): When the outdoor unit is combined with indoor units RPI-8/10FSN2E, it's necessary an additional refrigerant charge (W_2) = 1 kg/unit.

ITEM		DOWN-SIZE DISTRIBUTOR AND MULTI-KITS SYSTEM WITH REDUCTION
Example of systems		
<p>6: Line distribution method where the length from the first branch to the farthest indoor unit is between 40 and 90 m. (Down-size)</p> <p>This figure shows examples of 6 indoor units combined with one outdoor unit.</p> <p>The refrigerant pipes are shown as a single line in the diagrams.</p> <p>However, liquid line piping and gas line piping are required in the field.</p>		
Total piping length		≤ 1000 m
Maximum piping length	Actual length	Lt ≤ 165 m
	Equivalent length	Lt ≤ 190 m
Maximum lift between outdoor and indoor unit	In the case that the position of outdoor unit is higher than that of indoor unit.	H1 ≤ 50 m
	In the case that the position of outdoor unit is lower than that of indoor unit.	H1 ≤ 40 m
Maximum lift between each indoor unit, or multi-kit and indoor unit		H2 ≤ 15 m
Maximum piping length between multi-kit and indoor unit	Between the "a" kit and the farthest indoor unit	L ≤ 90 m (*1)
	Between each multi-kit and each indoor unit	L0, L1, L2, L3, L4, L5 ≤ 40 m

Example: Outdoor unit: RAS-20FSN2

Choice of each multi-kit		Mark	a	b	c	d																																	
		Multi-kit	MW-242AN	MW-162AN	MW-102AN	MH-84HAN																																	
<p>1) Additional refrigerant charge quantity</p> <p>The quantity is calculated by the following equation:</p> $W \text{ (kg)} = W_{11} + W_{12} + W_{13} + W_{14} + W_{15} + W_{16} + W_2$																																							
<p>1.1) Liquid piping</p> <p>1.1) W_{11} (kg): (Total length (m) of $\varnothing 22.2$ Liquid piping) x 0.39</p> <p>W_{12} (kg): (Total length (m) of $\varnothing 19.05$ Liquid piping) x 0.28</p> <p>W_{13} (kg): (Total length (m) of $\varnothing 15.88$ Liquid piping) x 0.19</p> <p>W_{14} (kg): (Total length (m) of $\varnothing 12.7$ Liquid piping) x 0.12</p> <p>W_{15} (kg): (Total length (m) of $\varnothing 9.53$ Liquid piping) x 0.07</p> <p>W_{16} (kg): (Total length (m) of $\varnothing 6.35$ Liquid piping) x 0.030</p>	1.2) Indoor unit	<p>Example:</p> <table border="1"> <thead> <tr> <th>Mark</th> <th>LM1</th> <th>LM2</th> <th>LM3</th> <th>LM4</th> <th>L0</th> <th>L1</th> <th>L2</th> <th>L3</th> <th>L4</th> <th>L5</th> </tr> </thead> <tbody> <tr> <td>Size</td> <td>$\varnothing 15.88$</td> <td>$\varnothing 12.7$</td> <td>$\varnothing 9.53$</td> <td>$\varnothing 9.53$</td> <td>$\varnothing 9.53$</td> <td>$\varnothing 9.53$</td> <td>$\varnothing 9.53$</td> <td>$\varnothing 6.35$</td> <td>$\varnothing 6.35$</td> <td>$\varnothing 6.35$</td> </tr> <tr> <td>Length</td> <td>50</td> <td>20</td> <td>10</td> <td>20</td> <td>10</td> <td>14</td> <td>20</td> <td>7</td> <td>12</td> <td>10</td> </tr> </tbody> </table> <p>$W_{13} = 50 \times 0.19 = 9.5 \text{ kg}$; $W_{15} = (10+20+10+14+20) \times 0.07 = 5.18 \text{ kg}$ $W_{14} = 20 \times 0.12 = 2.4 \text{ kg}$; $W_{16} = (7+12+10) \times 0.03 = 0.87 \text{ kg}$</p>					Mark	LM1	LM2	LM3	LM4	L0	L1	L2	L3	L4	L5	Size	$\varnothing 15.88$	$\varnothing 12.7$	$\varnothing 9.53$	$\varnothing 9.53$	$\varnothing 9.53$	$\varnothing 9.53$	$\varnothing 9.53$	$\varnothing 6.35$	$\varnothing 6.35$	$\varnothing 6.35$	Length	50	20	10	20	10	14	20	7	12	10
		Mark	LM1	LM2	LM3	LM4	L0	L1	L2	L3	L4	L5																											
	Size	$\varnothing 15.88$	$\varnothing 12.7$	$\varnothing 9.53$	$\varnothing 9.53$	$\varnothing 9.53$	$\varnothing 9.53$	$\varnothing 9.53$	$\varnothing 6.35$	$\varnothing 6.35$	$\varnothing 6.35$																												
	Length	50	20	10	20	10	14	20	7	12	10																												
	1.2) W_2 (kg): Total quantity of additional refrigerant of each indoor unit (kg)	Total	<p>Example:</p> <table border="1"> <thead> <tr> <th>Indoor Unit No.</th> <th>0</th> <th>1</th> <th>2</th> <th>3</th> <th>4</th> <th>5</th> </tr> </thead> <tbody> <tr> <td>Corresponding power (HP)</td> <td>4</td> <td>5</td> <td>5</td> <td>2</td> <td>2</td> <td>2</td> </tr> <tr> <td>Additional refrigerant quantity</td> <td colspan="6">Indoor units that do not require ref. charge</td> </tr> </tbody> </table> <p>$W_2 = 0 \text{ kg}$</p>					Indoor Unit No.	0	1	2	3	4	5	Corresponding power (HP)	4	5	5	2	2	2	Additional refrigerant quantity	Indoor units that do not require ref. charge																
			Indoor Unit No.	0	1	2	3	4	5																														
Corresponding power (HP)	4	5	5	2	2	2																																	
Additional refrigerant quantity	Indoor units that do not require ref. charge																																						
		<p>$W \text{ (kg)} = W_{11} + W_{12} + W_{13} + W_{14} + W_{15} + W_{16} + W_2$ $= 0 + 0 + 9.5 + 2.4 + 5.18 + 0.87 = 17.95 \text{ kg}$</p>																																					
2) Checking the maximum quantity of additional refrigerant charge: ($W < W_{MAX}$)		17.95 kg < 51 kg (CORRECT)																																					
3) Total refrigerant charge: $W_{TOT} \text{ (kg)} = W_0 + W$ W_0 : Outdoor unit refrigerant charge before shipment (kg)		$W_{TOT} = 19.5 + 17.95 = 37.45 \text{ kg}$																																					

NOTES:

- Refer to "Refrigerant piping work" to know all the information necessary for the calculation of the additional refrigerant charge.
- Refer to "Additional refrigerant charge calculation" in this chapter to know the maximum quantity of additional refrigerant charge (W_{MAX}) and the outdoor unit refrigerant charge before shipment (W_0).
- (*1): When the first branch divides the installation into 2 parts or more and the length from first branch to the farthest indoor unit is within 40 to 90 m, this parts must be equilibrated. The ratio of total indoor unit capacity after the first branch must be within 40-60%. In this example we have this installation type. Therefore, it's necessary to check the piping length and the indoor unit capacity at the 2 parts:
 - a) From a to indoor unit n°4 (Length: (20+12)) = 32 m; (2+2+2)/20 = 0.3 (30%).
 - b) From a to indoor unit n°2 (Length: (30+20)) = 50 m; (4+5+5)/20 = 0.7 (70%). This case is INCORRECT because the piping length is over 40 m and the indoor unit capacity is not within 40-60%. Therefore, we should equilibrate the indoor unit capacity at the 2 parts or to adjust the piping length, maximum 40 m.

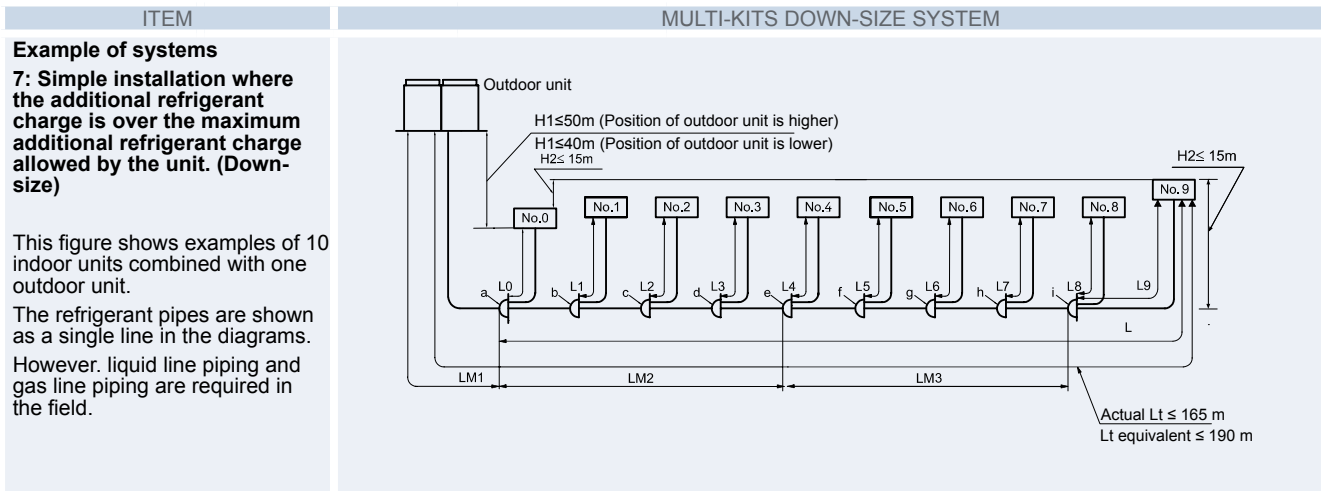

Total piping length		≤ 1000 m
Maximum piping length	Actual length	Lt ≤ 165 m
	Equivalent length	Lt ≤ 190 m
Maximum lift between outdoor and indoor unit	In the case that the position of outdoor unit is higher than that of indoor unit.	H1 ≤ 50 m
	In the case that the position of outdoor unit is lower than that of indoor unit.	H1 ≤ 40 m
Maximum lift between each indoor unit. or Multi-kit and indoor unit		H2 ≤ 15 m
Maximum piping length between Multi-kit and indoor unit	Between the "a" kit and the farthest indoor unit	L ≤ 90 m
	Between each Multi-kit and each indoor unit	L0. L1. L2. L3. L4. L5 ≤ 40 m

Example: Outdoor unit: RAS-16FSN2

Choice of each multi-kit	Mark	a,b,c,d,e	f,g,h,i
	Multi-kit	MW-162AN	MW-102AN

<p>1) Quantity of additional refrigerant charge.</p> <p>The quantity is calculated by the following equation:</p> $W \text{ (kg)} = W_{11} + W_{12} + W_{13} + W_{14} + W_{15} + W_{16} + W_2$ <p>1.1) W_{11} (kg): (Total length (m) of Ø22.2 Liquid piping) x 0.39</p> <p>W_{12} (kg): (Total length (m) of Ø19.05 Liquid piping) x 0.28</p> <p>W_{13} (kg): (Total length (m) of Ø15.88 Liquid piping) x 0.19</p> <p>W_{14} (kg): (Total length (m) of Ø12.7 Liquid piping) x 0.12</p> <p>W_{15} (kg): (Total length (m) of Ø9.53 Liquid piping) x 0.07</p> <p>W_{16} (kg): (Total length (m) of Ø6.35 Liquid piping) x 0.030</p> <p>1.2) W_2 (kg): Total quantity of additional refrigerant of each indoor unit (kg)</p>	<p>Example:</p> <table border="1"> <thead> <tr> <th>Mark</th> <th>LM1</th> <th>LM2</th> <th>LM3</th> <th>L0</th> <th>L1</th> <th>L2</th> <th>L3</th> <th>L4</th> <th>L5</th> <th>L6</th> <th>L7</th> <th>L8</th> <th>L9</th> </tr> </thead> <tbody> <tr> <td>Size</td> <td>Ø15.88</td> <td>Ø12.7</td> <td>Ø9.53</td> <td>Ø9.53</td> <td>Ø9.53</td> <td>Ø9.53</td> <td>Ø9.53</td> <td>Ø9.53</td> <td>Ø9.53</td> <td>Ø9.53</td> <td>Ø9.53</td> <td>Ø9.53</td> <td>Ø9.53</td> </tr> <tr> <td>Length</td> <td>91</td> <td>25</td> <td>20</td> <td>30</td> <td>30</td> <td>30</td> <td>30</td> <td>30</td> <td>30</td> <td>30</td> <td>30</td> <td>25</td> <td>28</td> </tr> </tbody> </table> <p>$W_{13} = 91 \times 0.19 = 17.29 \text{ kg}$; $W_{14} = 25 \times 0.12 = 3 \text{ kg}$ $W_{15} = (20 + (30 \times 8) + 25 + 28) \times 0.07 = 21.91 \text{ kg}$</p>	Mark	LM1	LM2	LM3	L0	L1	L2	L3	L4	L5	L6	L7	L8	L9	Size	Ø15.88	Ø12.7	Ø9.53	Ø9.53	Ø9.53	Ø9.53	Ø9.53	Ø9.53	Ø9.53	Ø9.53	Ø9.53	Ø9.53	Ø9.53	Length	91	25	20	30	30	30	30	30	30	30	30	25	28
	Mark	LM1	LM2	LM3	L0	L1	L2	L3	L4	L5	L6	L7	L8	L9																													
Size	Ø15.88	Ø12.7	Ø9.53	Ø9.53	Ø9.53	Ø9.53	Ø9.53	Ø9.53	Ø9.53	Ø9.53	Ø9.53	Ø9.53	Ø9.53																														
Length	91	25	20	30	30	30	30	30	30	30	30	25	28																														
	<p>Example:</p> <table border="1"> <thead> <tr> <th>Indoor Unit No.</th> <th>0</th> <th>1</th> <th>2</th> <th>3</th> <th>4</th> <th>5</th> <th>6</th> <th>7</th> <th>8</th> <th>9</th> </tr> </thead> <tbody> <tr> <td>Corresponding power (HP)</td> <td>1</td> <td>1</td> <td>1</td> <td>1</td> <td>1</td> <td>1</td> <td>2.5</td> <td>2.5</td> <td>2.5</td> <td>2.5</td> </tr> <tr> <td>Additional refrigerant quantity</td> <td colspan="10">Indoor units that do not require ref. charge</td> </tr> </tbody> </table> <p>$W_2 = 0 \text{ kg}$</p>	Indoor Unit No.	0	1	2	3	4	5	6	7	8	9	Corresponding power (HP)	1	1	1	1	1	1	2.5	2.5	2.5	2.5	Additional refrigerant quantity	Indoor units that do not require ref. charge										<p>Total</p> $W \text{ (kg)} = W_{11} + W_{12} + W_{13} + W_{14} + W_{15} + W_{16} + W_2$ $= 0 + 0 + 17.29 + 3 + 21.91 + 0 + 0 = 42.2 \text{ kg}$								
Indoor Unit No.	0	1	2	3	4	5	6	7	8	9																																	
Corresponding power (HP)	1	1	1	1	1	1	2.5	2.5	2.5	2.5																																	
Additional refrigerant quantity	Indoor units that do not require ref. charge																																										
2) Checking the maximum quantity of additional refrigerant charge: ($W < W_{MAX}$)		42.2 kg > 40 kg (INCORRECT) *(2)																																									
3) Total refrigerant charge: $W_{TOT} \text{ (kg)} = W_0 + W$ W_0 : Outdoor unit refrigerant charge before shipment (kg)		$W_{TOT} = 18.0 + 42.2 = 60.2 \text{ kg}$																																									

NOTES:

- Refer to "Refrigerant piping work" to know all the information necessary for the calculation of the additional refrigerant charge.
- Refer to "Additional refrigerant charge calculation" in this chapter to know the maximum quantity of additional refrigerant charge (W_{MAX}) and the outdoor unit refrigerant charge before shipment (W_0).
- (*1): In indoor units from 0.8 to 2.0HP, when the piping length from the multi-kit to the indoor units is over 15 m, the pipe size of the line should be increased with the reducer (field supplied) from Ø6.35 to Ø9.53.
- (*2): When the additional refrigerant charge is over the maximum additional refrigerant charge allowed by the unit, it's necessary to adjust the piping length of the installation.

7.4. Caution on refrigerant leakage

7.4.1. Maximum permissible concentration of HCFC/HFC gas

The refrigerant R410A, charged in the Set Free FSN2 system, is an incombustible and non-toxic gas. However, if leakage occurs and gas fills a room, it may cause suffocation.

The maximum permissible concentration of HCFC/HFC gas, R410A in air is 0.44 kg/m³, according to EN378-1

Therefore, some effective measure must be taken to lower the R410A concentration in air below 0.44 kg/m³, in case of leakage.

7.4.2. Calculation of refrigerant concentration

1. Calculate the total quantity of refrigerant R (kg) charged in the system connecting all the indoor units of rooms to be air-conditioned.
2. Calculate the room volume V (m³) of each room.
3. Calculate the refrigerant concentration C (kg/m³) of the room according to the following equation.

$$\frac{R}{V} \leq C$$

R: Total quantity of charged refrigerant (kg)
V: Room volume (m³)
C: Refrigerant concentration 0.44 kg/m³ for R410A

◆ Example of application

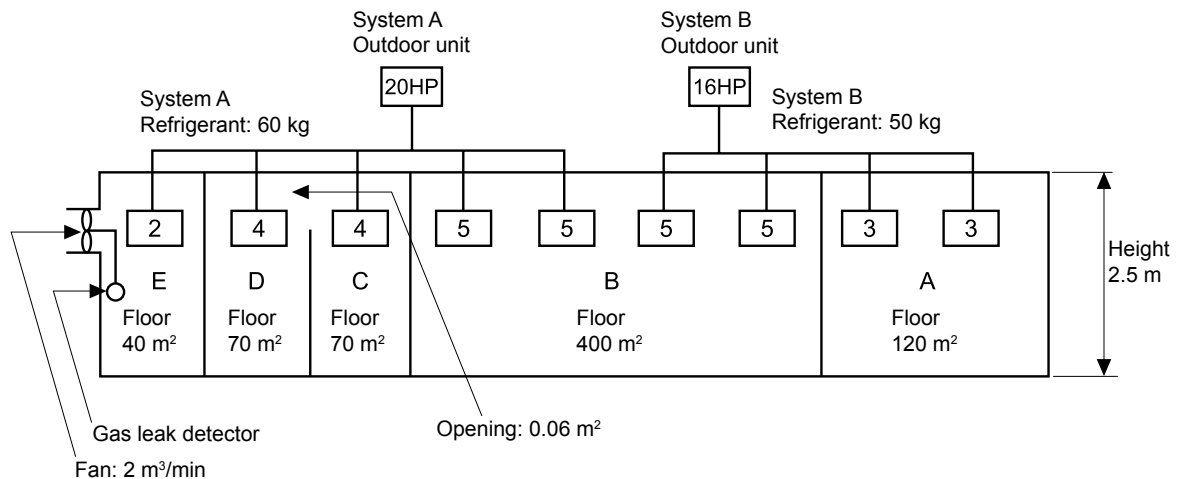

Room	R (kg)	V (m ³)	C (kg/m ³)	Countermeasure
A	50	300	0.17	-
B	110	1,000	0.11	-
C	60	175	0.34	0.06 m ² opening
D	60	175	0.34	0.06 m ² opening
C + D	60	350	0.171	-
E	60	100	0.6	2 m ³ /min. fan linked with gas leak detector

7.4.3. Countermeasure for refrigerant leakage

The facility must have the following features in case of fire:

1. Provide a shutterless opening which will allow fresh air to circulate into the room.
2. Provide a doorless opening of 0.15% or more size to the floor area.
3. Provide a ventilator, linked with a gas leak detector, of 0.4 m³/min. or more ventilating capacity per Japanese Refrigeration Ton (= compressor displacement 5.7 m³/h) of the air conditioning system utilizing refrigerant R410A.

Model	Tonnes
RAS-8~12FSN2	4.11
RAS-14/16FSN2	6.16
RAS-18/20FSN2	8.21
RAS-22/24FSN2	9.32
RAS-26/28FSN2	10.43
RAS-30~36FSN2	12.48
RAS-38~42FSN2	15.64
RAS-44~48FSN2	16.75

4. Pay a special attention to the place, such as a basement, etc., where refrigerant can stay, since refrigerant is heavier than air.

8. Electrical Data

This chapter describes the electrical requirements for each unit of the Hitachi SET FREE FSN2 series.

Contents

8. Electrical Data	175
8.1. Indoor Units	176
8.2. Outdoor Units RAS-8~48FSN2	177

8.1. Indoor Units

Model		Main Unit Power			Applicable Voltage		Fan Motor			
		U [V]	PH	f [Hz]	U max. [V]	U min [V]	IPT [kW]	RNC [A]	Max. IPT [kW]	Max. Cur. [A]
 4-way cassette type	RCI-1.0FSN2E	230	1	50	253	207	0.04	0.2	0.04	5.0
	RCI-1.5FSN2E	230	1	50	253	207	0.05	0.2	0.05	5.0
	RCI-2.0FSN2E	230	1	50	253	207	0.05	0.2	0.05	5.0
	RCI-2.5FSN2E	230	1	50	253	207	0.06	0.3	0.06	5.0
	RCI-3.0FSN2E	230			253	207	0.09	0.4	0.09	5.0
	RCI-4.0FSN2E	230			253	207	0.11	0.7	0.11	5.0
	RCI-5.0FSN2E	230			253	207	0.14	0.8	0.14	5.0
	RCI-6.0FSN2E	230			253	207	0.18	1.0	0.18	5.0
RCIM-1.0FSN2	220/240	1			50	198	264	PENDING		
RCIM-1.5FSN2	220/240	1	50	253	207	0.07	0.4	0.08	5.0	
RCIM-2.0FSN2	220/240	1	50	253	207	0.07	0.4	0.08	5.0	
 2-way cassette type	RCD-1.0FSN2	220/240	1	50	264	198	0.05/0.06	0.2/0.2	0.07	5.0
	RCD-1.5FSN2	220/240	1	50	253	207	0.07/0.08	0.3/0.4	0.10	5.0
	RCD-2.0FSN2	220/240			253	207	0.07/0.08	0.3/0.4	0.10	5.0
	RCD-2.5FSN2	220/240			253	207	0.09/0.11	0.4/0.5	0.13	5.0
	RCD-3.0FSN2	220/240			253	207	0.11/0.13	0.5/0.6	0.15	5.0
	RCD-4.0FSN2	220/240			253	207	0.12/0.14	0.6/0.6	0.17	5.0
	RCD-5.0FSN2	220/240			253	207	0.18/0.20	0.8/0.9	0.24	5.0
 Ceiling type	RPC-2.0FSN2E	230			1	50	253	207	0.13	0.5
	RPC-2.5FSN2E	230	253	207			0.13	0.6	0.18	5.0
	RPC-3.0FSN2E	230	253	207			0.17	0.8	0.23	5.0
	RPC-4.0FSN2E	230	253	207			0.18	0.8	0.24	5.0
	RPC-5.0FSN2E	230	253	207			0.23	1.1	0.31	5.0
	RPC-6.0FSN2E	230	253	207			0.23	1.1	0.31	5.0
 In-the-ceiling type	RPI-0.8FSN2E	230	1	50	253	207	0.07	0.3	0.80	5.0
	RPI-1.0FSN2E	230	1	50	253	207	0.07	0.3	0.80	5.0
	RPI-1.5FSN2E	230	1	50	253	207	0.07	0.4	0.90	5.0
	RPI-2.0FSN2E	230	1	50	253	207	0.13	0.6	0.17	5.0
	RPI-2.5FSN2E	230			253	207	0.14	0.6	0.19	5.0
	RPI-3.0FSN2E	230			253	207	0.20	0.9	0.30	5.0
	RPI-4.0FSN2E	230			253	207	0.28	1.4	0.37	5.0
	RPI-5.0FSN2E	230			253	207	0.30	1.5	0.37	5.0
	RPI-6.0FSN2E	230			253	207	0.33	1.7	0.45	5.0
	RPI-8.0FSNE	230	1	50	264	198	0.97	4.5	1.75	10.0
RPI-10.0FSNE	230	1	50	264	198	1.06	4.8	1.91	10.0	
 RPIM type	RPIM-0.8FSN2E	230	1	50	253	207	0.08	0.3	0.09	5.0
	RPIM-1.0FSN2E	230	1	50	253	207	0.08	0.3	0.09	5.0
	RPIM-1.5FSN2E	230	1	50	253	207	0.09	0.3	0.09	5.0
	 Wall type	RPK-1.0FSNH2M	220/240	1	50	264	198	0.03/0.03	0.2/0.2	0.04
RPK-1.5FSNH2M		220/240	1	50	264	198	0.03/0.03	0.3/0.3	0.04	5.0
RPK-1.0FSN2M		220/240	1	50	264	198	0.03/0.03	0.2/0.2	0.04	5.0
RPK-1.5FSN2M		220/240	1	50	253	207	0.03	0.3	0.04	5.0
RPK-2.0FSN2M		220/240			253	207	0.03	0.3	0.04	5.0
RPK-2.5FSN2M		220/240			253	207	0.04	0.3	0.05	5.0
RPK-3.0FSN2M		220/240			253	207	0.04	0.3	0.05	5.0
RPK-4.0FSN2M		220/240			253	207	0.06	0.5	0.09	5.0
 Floor type	RPF-1.0FSN2E	230			1	50	253	207	0.04	0.2
	RPF-1.5FSN2E	230	1	50	253	207	0.05	0.2	0.07	5.0
	RPF-2.0FSN2E	230			253	207	0.09	0.4	0.12	5.0
	RPF-2.5FSN2E	230			253	207	0.09	0.4	0.12	5.0
 Floor-concealed type	RPFI-1.0FSN2E	230			1	50	253	207	0.04	0.2
	RPFI-1.5FSN2E	230	1	50	253	207	0.05	0.2	0.07	5.0
	RPFI-2.0FSN2E	230			253	207	0.09	0.4	0.12	5.0
	RPFI-2.5FSN2E	230			253	207	0.09	0.4	0.12	5.0

U: Power voltage
PH: Phase (φ)
f: Frequency
RNC: Running current
IPT: Total input power
Cur: Current

NOTE:

The specifications in these tables are subject to change without notice to allow HITACHI to offer its customers the latest innovations.

8.2. Outdoor Units RAS-8~48FSN2

Model	Main Unit Power			Applicable Voltage		Compressor and Fan Motors						Max. IPT [kW]	Max. Cur. [A]
	U [V]	PH	f [Hz]	U max. [V]	U min [V]	PH	STC [A]	Cooling Operation		Heating Operation			
								IPT [kW]	RNC [A]	IPT [kW]	RNC [A]		
RAS-8FSN2	380/ 415	3	50	456	342	3	8/8	5.50	9.0/8.3	5.30	8.7/8.0	7.1	12
RAS-10FSN2							8/8	6.90	11.4/10.5	6.80	11.2/10.2	9.0	15
RAS-12FSN2							8/8	8.70	14.2/13.0	9.40	15.3/14.0	12.2	20
RAS-14FSN2							54/49	10.20	17.2/16.4	9.90	16.7/15.9	13.3	22
RAS-16FSN2							54/49	11.50	19.4/18.4	11.30	18.9/17.9	15.0	25
RAS-18FSN2							59/54	13.20	22.5/21.7	12.50	21.4/20.7	17.1	29
RAS-20FSN2							59/54	15.20	25.7/24.8	15.30	25.8/24.9	19.8	34
RAS-22FSN2							84/77	17.30	29.2/28.4	17.80	30.1/29.2	23.1	39
RAS-24FSN2							84/77	19.10	32.1/31.1	18.80	31.5/30.5	24.8	43
RAS-26FSN2							90/83	18.90	31.6/30.7	18.90	31.5/30.6	24.6	44
RAS-28FSN2							90/83	21.20	35.4/34.3	21.50	35.9/34.8	28.0	48
RAS-30FSN2							95/87	22.50	38.0/37.1	22.30	37.6/36.7	29.3	51
RAS-32FSN2							95/87	24.00	40.3/39.3	24.20	40.6/39.5	31.4	54
RAS-34FSN2							95/87	25.90	43.5/42.3	25.80	43.2/42.0	33.7	58
RAS-36FSN2							95/87	27.60	46.1/44.5	27.60	46.1/44.6	35.9	62
RAS-38FSN2							103/95	29.60	49.9/49.0	29.00	48.9/48.0	38.5	67
RAS-40FSN2							103/95	32.30	54.4/53.3	31.80	53.5/52.4	42.0	74
RAS-42FSN2							103/95	33.90	56.9/55.6	32.70	54.9/53.6	44.1	77
RAS-44FSN2							110/101	34.80	58.5/57.3	33.70	56.5/55.3	45.3	79
RAS-46FSN2							110/101	37.20	62.3/61.0	36.20	60.5/59.2	48.4	84
RAS-48FSN2	110/101	39.20	65.6/64.1	37.80	63.2/61.7	51.0	89						

U: Power voltage
 PH: Phase (φ)
 f: Frequency
 STC: Starting current
 RNC: Running current
 IPT: Total input power
 Cur: Current

i NOTES:

1. The above performance data is based on 100% capacity combination of the indoor units and rated operating compressor frequency.
2. The above performance data is based on 7.5 m equivalent piping length and 0 m piping lift.
3. The compressor is started by an inverter, resulting in extremely low starting current.
4. These data are based on the same conditions of the nominal heating and cooling capacities.

9. Electrical Wiring

This chapter describes the electrical wiring connections and how to set the dip switches of the Hitachi SET FREE FSN2 Series.

Contents

9. Electrical Wiring.....	179
9.1 General Check.....	180
9.2. Setting and Function of DIP Switches for RAS-FSN2	181
9.3. Common Wiring.....	185
9.3.1. Electrical wiring between indoor and outdoor units.....	185
9.4. Wiring Size	186

9.1 General Check



WARNING:

- Turn OFF the main power switch on the indoor and outdoor units before carrying out electrical wiring or regular checks.
- Check to ensure that the indoor fan and the outdoor fan have stopped before electrical wiring work or a periodical check is performed.
- Protect wires, drainpipe, electrical parts, etc. from rats or other small animals.
If all these parts are not protected, rats or other small animals may gnaw at them and possibly cause a fire.
- Make sure the wires are not touching the refrigerant pipes, plate edges and electrical parts on the inside of the unit. Otherwise the wires will be damaged and may cause a fire.



WARNING:

Secure the wires firmly with the clamp to the inside of the indoor unit.



NOTE:

Fix the rubber bushes with adhesive when the outdoor unit ducts are not used.

1. Make sure that the field-supplied electrical components (main power switches, circuit breakers, wires, duct connectors and wire terminals) have been properly selected according to the electrical data in this technical catalog. Make sure that the components comply with the National Electrical Code (NEC).
2. Check to ensure that the power supply voltage is within $\pm 10\%$ of the rated voltage.
3. Check the capacity of the electrical wiring. If the power source capacity is too low, the system cannot be started due to voltage drop.
4. Check to ensure that the earth wire is connected.
5. Main power source switch
Install a multi-pole main switch with a space of 3.5mm or more between each phase.

9.2. Setting and Function of DIP Switches for RAS-FSN2



NOTE:

- The mark "■" indicates position of dips switches. Figures show setting before shipment or after selection.
- By using DSW4, the unit is started or stopped after 10 to 20 seconds after the switch is operated.
- Number this outdoor unit to distinguish from other outdoor units for service and maintenance. And write the number in the space right.

◆ **Quantity and Position of DIP Switches**

The PCB in the outdoor unit is operated with 10 types of dip switches and 3 types of push switch.

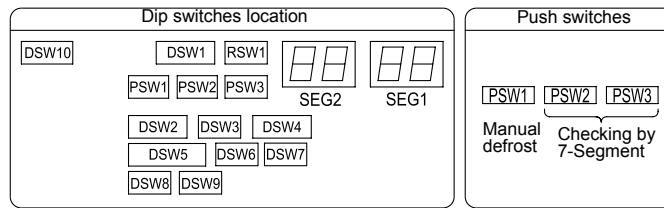

◆ **DSW1: Ref. cycle n° setting**

Set the unit number of outdoor unit at each refrigerant cycle. (Setting before shipment is unit 0.)

Setting is required

- **DSW1**

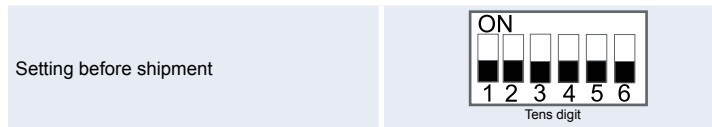

- **RSW1**

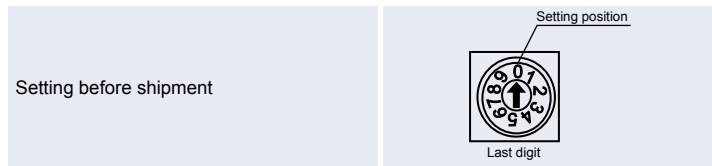

CAUTION:

Before setting dips switches, firstly turn off power source and set the position of the dips switches. If the switches are set without turning off the power source, the contents of the setting are invalid.

◆ **DSW2: Capacity setting**

No setting is required

Model	Setting Position	Model	Setting Position	Model	Setting Position	Model	Setting Position
RAS-8FSN2		RAS-20FSN2		RAS-32FSN2		RAS-44FSN2	
RAS-10FSN2		RAS-22FSN2		RAS-34FSN2		RAS-46FSN2	
RAS-12FSN2		RAS-24FSN2		RAS-36FSN2		RAS-48FSN2	
RAS-14FSN2		RAS-26FSN2		RAS-38FSN2			
RAS-16FSN2		RAS-28FSN2		RAS-40FSN2			
RAS-18FSN2		RAS-30FSN2		RAS-42FSN2			

◆ **DSW3: Lift difference setting**

Setting is required

Setting before shipment The outdoor unit is located higher than indoor unit (0~50m) The outdoor unit is located lower than indoor unit (0~20m)	
The outdoor unit is located lower than indoor unit (20~40m)	
Heating capacity regulation for height difference	

◆ **DSW4: Test operation and service setting**

Setting is required

For test operation and operating compressor

Setting before shipment		Forced compressor stop	
Test cooling operation		Operation for exchange compressor	
Test heating operation			

◆ **DSW5: Optional function setting**

Setting is required

For optional functions

Setting before shipment		Except compressor N°5	
Except compressor N°1		Judgment for ref. charge	
Except compressor N°2		Selection of input signal	
Except compressor N°3		Function setting	
Except compressor N°4			

◆ **DSW6: Refrigerant piping length setting**

Setting is required

Actual piping length l (m)

Setting before shipment $l < 25$		$50 \leq l < 75$	
$25 \leq l < 50$		$75 \leq l$	

◆ **DSW7: Power supply setting**

Setting is required

380V (Setting before shipment)	
415V	

◆ **DSW8: Unit model code setting**

No setting is required

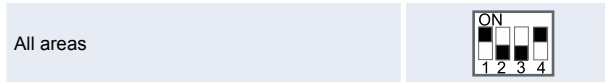

◆ **DSW9: Not prepared**

No setting is required

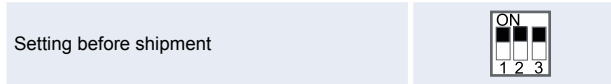

◆ **DSW10: Transmission setting**

Setting is required

For end resistance cancellation

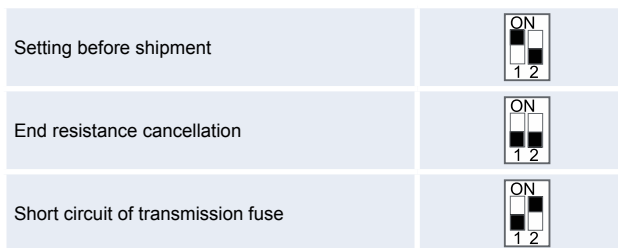

◆ **Setting for Transmitting**

It is required to set the refrigerant cycle Nos. and end terminal resistance for this H-LINK or H-LINKII system.

◆ **Setting of Refrigerant Cycle No.**

In the same refrigerant cycle, set the same refrigerant cycle N° for the outdoor unit and the indoor units as shown below.

As for setting indoor unit refrigerant cycle N°, set the RSW2 and DSW5 on the indoor unit PCB.

Setting Switch		
	10 digit	1 digit
		Setting position Set by inserting slotted screwdriver into the groove
Outdoor unit	DSW1	RSW1
Indoor unit (H-LINK II)	DSW5	RSW2

Ex.: In case of setting refrigerant cycle N° 25

Turn ON N° 2 pin	Set dial N° 5

DSW and RSW setting before shipment is 0.
 Maximum in setting refrigerant cycle No. is 63.

◆ **Setting of end Terminal Resistance**

Before shipment, No. 1 pin of DSW10 is set at the "ON" side. In the case that the outdoor units quantity in the same H-LINK or H-LINKII is 2 or more, set No. 1 pin of DSW10 at the "OFF" side from the 2nd unit. If only one outdoor unit is used, no setting is required.

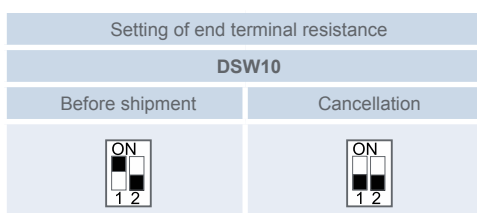

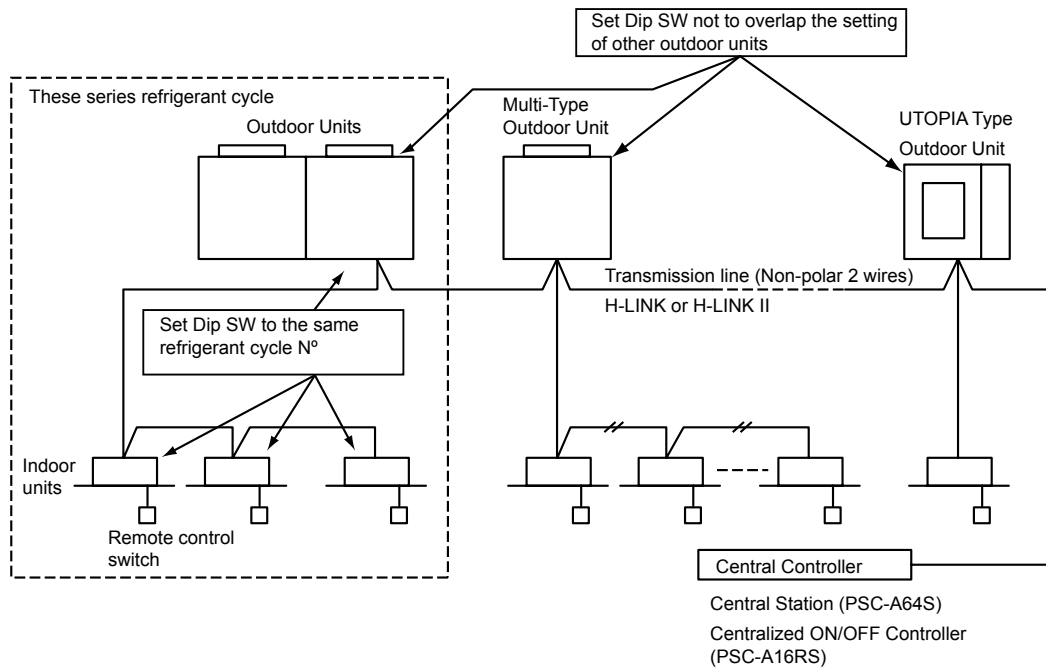

**Maximum Units per Refrigerant System
(In Case of H-LINK II)**

Outdoor Unit	64 units
Indoor Unit	160 units

i NOTE

If H-LINK II adaptive and non-adaptive indoor and outdoor unit are connected together, the maximum indoor units to be connected are 128 units.

9.3. Common Wiring

9.3.1. Electrical wiring between indoor and outdoor units

- Connect the electrical wires between the indoor unit and the outdoor unit as shown below.
- When installing the electrical wiring, follow local codes and regulations.
- The refrigerant piping and the control wiring are connected to the units in the same refrigerant cycle.
- Use twist pair wire (more than 0.75mm²) for operation wiring between the outdoor unit and indoor unit, and operation wiring between indoor unit and indoor unit.
- Use a 2-core wire for the operating line (do not use wire with more than 3 cores).
- Use shielded wires for intermediate wiring to protect the units from noise interference at lengths of less than 300m. The size must comply with local code.
- Open a hole near the connection hole of power source wiring when multiple outdoor units are connected from a single power source line.
- The recommended circuit-breaker sizes are shown in the table of electrical data and recommended wiring and breaker sizes / 1 O.U.
- If a duct for field-supplied wiring is not used, fix rubber bushes with adhesive on the panel.
- All field wiring and equipment must comply with local and international codes.



WARNING:

Take care with the connection of the operating line. Incorrect connection may cause a failure of the PCB.

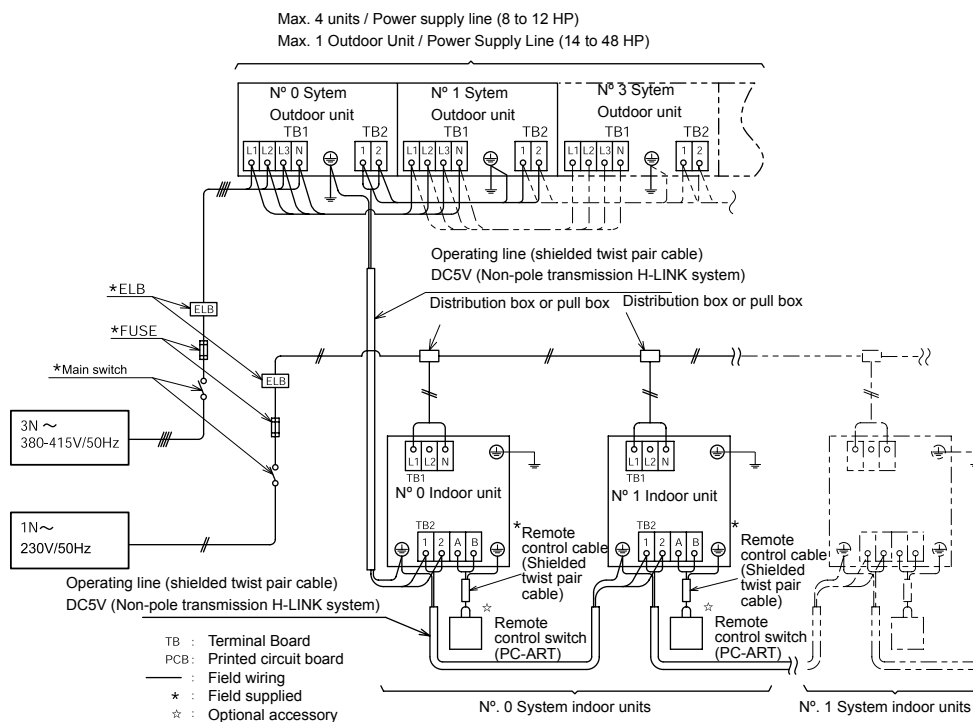

9.4. Wiring Size

◆ Connection Wiring

The minimum thickness of the wiring that must be used in the installation.

◆ Indoor units

Model	Power Supply	Maximum Current (A)	Power Source Cable Size		Transmission Cable Size	
			EN60 335-1 ①	MLFC ②	EN60 335-1 ①	Shielded twist Pair Cable
All indoor units (*)	1~230V/50Hz	5.0	0.75mm ²	0.75mm ²	0.75mm ²	0.5mm ²
RPI-(8.0/10.0)FSN2E		10.0	1.5mm ²			

(*) Except RPI-8/10

◆ Outdoor units

Model	Power Supply	Maximum Current	Power Source Cable Size		Transmitting Cable Size	
			EN60 335-1 ①	MLFC ②	EN60 335-1 ①	MLFC ②
RAS-8FSN2	380-415V/50Hz	12	2.5mm ²	2.0mm ²	0.75mm ²	0.75mm ²
RAS-10FSN2		15	2.5mm ²	2.0mm ²		
RAS-12FSN2		20	4mm ²	3.5mm ²		
RAS-14FSN2		22	4mm ²	3.5mm ²		
RAS-16FSN2		25	4mm ²	3.5mm ²		
RAS-18FSN2		29	6mm ²	5.5mm ²		
RAS-20FSN2		34	10mm ²	5.5mm ²		
RAS-22FSN2		39	10mm ²	8mm ²		
RAS-24FSN2		43	-	8mm ²		
RAS-26FSN2		44	-	14mm ²		
RAS-28FSN2		48	-	14mm ²		
RAS-30FSN2		51	-	14mm ²		
RAS-32FSN2		54	-	14mm ²		
RAS-34FSN2		58	-	14mm ²		
RAS-36FSN2		62	-	14mm ²		
RAS-38FSN2		67	-	14mm ²		
RAS-40FSN2		74	-	22mm ²		
RAS-42FSN2		77	-	22mm ²		
RAS-44FSN2		79	-	22mm ²		
RAS-46FSN2		84	-	22mm ²		
RAS-48FSN2	89	-	22mm ²			



NOTES:

- Follow local codes and regulations when selecting field wires.
- The wire sizes marked with *1 in the table of this page are selected at the maximum current of the unit according to the European Standard, EN60 335-1. Use the wires which are not lighter than the ordinary tough rubber sheathed flexible cord (code designation H05RN-F) or ordinary polychloroprene sheathed flexible cord (code designation H05RN-F).
- The wire sizes marked with *2 in the table of this page are selected at the maximum current of the unit according to the wire, MLFC (Flame Retardant Polyflex Wire) manufactured by Hitachi Cable Ltd., Japan.
- Use a shielded cable for the transmitting circuit and connect it to ground.
- In the case that power cables are connected in series, add each unit maximum current and select wires below.
- The earth cable size complied with local code: IEC 245, N°571.

Selection According to EN60 335-1		Selection According to MLFC (at cable temp. of 60°C)	
Current i (A)	Wire size (mm ²)	Current i (A)	Wire size (mm ²)
1 ≤ i	0.75	1 ≤ 15	0.5
6 < i ≤ 10	1.0	15 < i ≤ 18	0.75
10 < i ≤ 16	1.5	18 < i ≤ 24	1.25
16 < i ≤ 25	2.5	24 < i ≤ 34	2
25 < i ≤ 32	4.0	34 < i ≤ 47	3.5
32 < i ≤ 40	6.0	47 < i ≤ 62	5.5
40 < i ≤ 63	10.0	62 < i ≤ 78	8.0
63 < i	③	78 < i ≤ 112	14.0
		112 < i ≤ 147	22.0



NOTE:

- In the case that current exceeds 63A, use MLFC cables, and do not connect cables in series.



CAUTION:

Install a multi-pole main switch with a space of 3.5 mm or more between each phase.

◆ **Main Switch Protection**

Select the main switches according to the following table.

◆ **Indoor units**

Model	Power Supply	Maximum Current (A)	CB (A)	ELB No. of Poles/A/mA
All indoor units (*)	1~230V/50Hz	5.0	6.0	2/40/30
RPI-(8.0/10.0)FNSN2E		10.0	16.0	

(*) Except RPI-8/10

◆ **Outdoor units**

Model	Power Supply	Maximum Current (A)	CB (A)	ELB No. of Poles/A/mA
RAS-8FNSN2	3~380-415V/50Hz	12	15	4/20/30
RAS-10FNSN2		15	20	4/20/30
RAS-12FNSN2		20	30	4/30/30
RAS-14FNSN2		22	30	4/30/30
RAS-16FNSN2		25	30	4/40/30
RAS-18FNSN2		29	40	4/40/30
RAS-20FNSN2		34	40	4/50/100
RAS-22FNSN2		39	50	4/50/100
RAS-24FNSN2		43	50	4/60/100
RAS-26FNSN2		44	60	4/60/100
RAS-28FNSN2		48	75	4/75/100
RAS-30FNSN2		51	75	4/75/100
RAS-32FNSN2		54	75	4/75/100
RAS-34FNSN2		58	75	4/75/100
RAS-36FNSN2		62	75	4/100/100
RAS-38FNSN2		67	75	4/100/100
RAS-40FNSN2		74	100	4/100/100
RAS-42FNSN2		77	100	4/100/100
RAS-44FNSN2		79	100	4/100/100
RAS-46FNSN2		84	100	4/125/100
RAS-48FNSN2	89	100	4/125/100	



NOTE:

ELB: Earthleakage Breaker.
 CB: Circuit Breaker.

10. Optional Functions Available

This chapter gives a brief explanation of the optional functions available for the SET FREE FSN2 Series

Contents

Contenido

10. Optional Functions Available	189
10.1. Optional Functions Available for Outdoor Units	190

10.1. Optional Functions Available for Outdoor Units

Optional functions	
Optional function	Explanation
Fixing Operation Mode (Heating / Cooling)	This function fixes the operation mode, heating or cooling. If indoor unit is set on Heating (Cooling) mode when Cooling (Heating) mode is fixed, the indoor unit will be Thermo-OFF.
Thermostatic stoppage order.	When this function is activated the compressor is stopped and the indoor units are put under Thermo-OFF condition.
Snow sensor	This function operates all the outdoor fans at full speed during compressor stoppage if it detects the snow sensor is covered.
Enforced stoppage	This function produces an emergency stoppage, compressor and indoor fans do not operate.
Changeover of defrosting condition	This function changes the defrosting operation conditions. It is especially useful in cold areas.
Demand Current Control	This function regulates Outdoor running current, 60%, 70%, 80%, if demanded current is above set current the indoor unit capacity is reduced still thermo off if needs
Indoor unit fan control during thermo-OFF at heating	This function activates the Indoor fans as a cycle (2 min ON, 6 min OFF) in order to reduce the unpleasant aspects of Indoor Thermo-OFF working conditions.
Cancellation of heating outdoor ambient temperature limit	This function allows to operate in heating mode without upper ambient temperatures restriction.
Cancellation of cooling outdoor ambient temperature limit	This function allows to operate in cooling mode without low ambient temperatures restriction.
Night mode (low sound) operation	This function decreases the sound levels of the units, and the cooling capacity is also decreased.
Slow defrost setting	When this function is activated the indoor fan speed at defrost mode changes to slow instead of stopping the fan.
Cancellation of Outdoor Hot-Start Limit	This function allows to start the Outdoor unit without waiting the Temperature of compressor is bigger than 40°C
Piping length setting	This function indicates to the unit the distance between the Outdoor and the farthest indoor unit is bigger than 100 m.
Low noise setting	This function reduces the maximum speed of the fan motor, consequently the noise level is reduced.
Wave function setting	This function regulates Outdoor running current, if demanded current is above set current the indoor unit capacity is reduced still thermo off if needs. The running current control is not a fixed value it is changing between a maximum value.
Priority Cooling Capacity Mode	
Priority Heating Capacity Mode	
Cold Draft (1/2)	IU discharge air temperature is too low the OU is changing the working conditions in order to avoid this low temperature air discharge
Signal Capture	This function provides information on the units operation, (Operation, Alarm, Compressor ON, Defrosting Signals) so the necessary devices can be activated
Signal capture	This function provides information on the unit's operations so the necessary devices can be activated.

 Available

 Not available

11. Troubleshooting

This chapter provides you with a concise description of the most common alarm codes of the new SET FREE FSN2 Series.

Contents

Contenido

11. Troubleshooting.....	191
11.1. Alarm Codes.....	192

If RUN lamp flashes for 2 seconds, there is a failure in transmission between the indoor unit and the remote control switch. Possible causes are:

- The remote cable is broken
 - Contact failure in remote control cable
 - IC or microcomputer defective
- In all cases, contact your service provider.

If RUN lamp flashes 5 times (5 seconds) with unit number and alarm code displayed, note the alarm code (see table below) and contact your service provider.

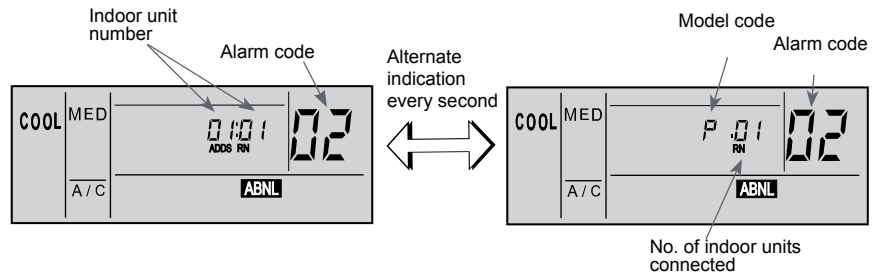

11.1. Alarm Codes

Code	Category	Content of Abnormality	Leading Cause
01	Indoor Unit	Activation of Protection Device	Activation of Float Switch, High Level in Drain Pan
02	Outdoor Unit	Activation of Protection Device	Activation of PSH, Pipe Clogging, Excessive Refrigerant, Inert Gas Mixing
03	Transmission	Abnormality between Indoor and Outdoor (or Outdoor and Outdoor)	Incorrect Wiring, Loose Terminals, Disconnect Wire, Tripping of Fuse
04	Transmission	Abnormality between Inverter PCB and Outdoor PCB Abnormality between Fan Controller and Outdoor PCB	Transmission Failure (Loose Connector), If only fan controller is failed, indications are as follows: No. 1 Fan Controller Failure - F1 04 No. 2 Fan Controller Failure - F2 04
05	Supply Phase	Abnormality Power Source Phases	Incorrect Power Source, Connection to Reversed-Phase, Open-Phase
06	Voltage	Abnormal Inverter Voltage	Outdoor Voltage Drop, Insufficient Power Capacity, If voltage drop cause by fan controller is detected, indications are as follows: No. 1 Fan Controller Failure - F1 06 No. 2 Fan Controller Failure - F2 06
07	Cycle	Decrease in Discharge Gas Superheat	Excessive Refrigerant Charge, Failure of Thermistor, Incorrect Wiring
08	Cycle	Increase in Discharge Gas Temperature	Insufficient Refrigerant Charge, Pipe Clogging, Failure of Thermistor, Incorrect Wiring
09	Fan Motor	Activation of Protection Device for Outdoor Fan	Fan Motor Overheat, Locking
11	Sensor on Indoor Unit	Inlet Air Thermistor	Incorrect Wiring, Disconnecting Wiring
12		Outlet Air Thermistor	
13		Freeze Protection Thermistor	
14		Gas Piping Thermistor	
16	Thermistor	Remote Thermistor	Incorrect Wiring, Disconnecting Wiring
17		Built-In Thermistor at Remote Control Switch	
19	Fan Motor	Activation of Protection Device for Indoor Fan	Fan Motor Overheat, Locking
21	Sensor on Outdoor Unit	High Pressure Sensor	Incorrect Wiring, Disconnecting Wiring
22		Outdoor Air Thermistor	
23		Discharge Gas Thermistor	
24		Evaporating Piping Thermistor	
29		Low Pressure Sensor	
31	System	Incorrect Capacity of Outdoor Unit and Indoor Unit	Incorrect Setting of Capacity Combination
35		Incorrect Setting of Indoor Unit No.	Duplication of Indoor Unit No.
38		Abnormality of Protective Circuit in Outdoor Unit	Failure of Protection Detecting Device
39	Compressor	Abnormal Current at Constant Compressor	Overcurrent, Tripping, Sensor Failure, Instantaneous Power Failure, Voltage Drop, Abnormal Power Supply
43	Protection Device	Activation of Low Pressure Decrease Protection Device	Defective Compression (Failure of Compressor of Inverter, Loose Power Supply Connection)
44		Activation of Low Pressure Increase Protection Device	Overload at Cooling, High Temp. at Heating, Locking (Loose Connector)
45		Activation of High Pressure Increase Protection Device	Overload Operation (Clogging, Short-Pass), Pipe Clogging, Insufficient Refrigerant, Inert Gas Mixing
47		Activation of Low Pressure Decrease Protection Device (Vacuum Operation)	Insufficient Refrigerant, Refrigerant Piping Clogging, Locking (Loose Connector)
48		Activation of Inverter Overcurrent Protection Device	Overload Operation, Compressor Failure
51	Sensor	Abnormal Current Sensor	Current Sensor Failure

◆ Alarm Codes (Cont.)

Code	Category	Content of Abnormality	Leading Cause
53	Inverter	Inverter Error Signal Detection	Driver IC Error Signal Detection (Protection for Overcurrent, Low Voltage, Short-Circuit)
54		Increase of Inverter Fin Temperature	Abnormal Inverter Fin Thermistor, Heat Exchanger Clogging, Abnormal Fan
55		Inverter Failure	Inverter PCB Failure
56	Outdoor Fan	Abnormal Detection of Fan Motor Position	Abnormal of Fan Motor Position Detection Circuit, Disconnected Wiring No. 1 Fan Controller Failure - F1 56 No. 2 Fan Controller Failure - F2 56
57	Fan Controller	Activation of Fan Controller Protection	Driver IC Error Signal Detection, Fin Temp. Increase No. 1 Fan Controller Failure - F1 57 No. 2 Fan Controller Failure - F2 57
58		Abnormal Fan Controller	Abnormal Operating Speed No. 1 Fan Controller Failure - F1 58 No. 2 Fan Controller Failure - F2 58
EE	Compressor	Compressor Protection Alarm	Failure of Compressor
b1	Outdoor Unit No. Setting	Incorrect Outdoor Unit No. Setting	Over 64 No. is Set for Address or Refrigerant Cycle.
b5	Indoor Unit No. Setting	Incorrect Indoor Unit No. Setting	More than 17 Non-Corresponding to H-LINKII Units are Connected to One System.



Hitachi Air Conditioning Products Europe, S.A.
 Ronda Shimizu, 1 - Políg. Ind. Can Torrella
 08233 Vacarisses (Barcelona) España
 ISO 9001 Certified by AENOR, Spain
 ISO 14001 Certified by AENOR, Spain

Hitachi Appliances, Inc.
 Shimizu-shi, Shizuoka-ken, Japan
 ISO 9001 Certified by JQA, Japan
 ISO 14001 Certified by JQA, Japan

Hitachi Air Conditioning Products (M) Sdn. Bnd.
 Lot No. 10, Jalan Kemajan Bangi Industrial Estate
 43650 Bandar Baru Bangi, Selangor Darul Ehsan, Malaysia
 Certification ISO 9001, Malaysia
 Certification ISO 14001, Malaysia

HITACHI
 Inspire the Next