

Basic Physical Chemistry

A Complete Introduction on Bachelor of Science Level

Dr Wolfgang Schärftl

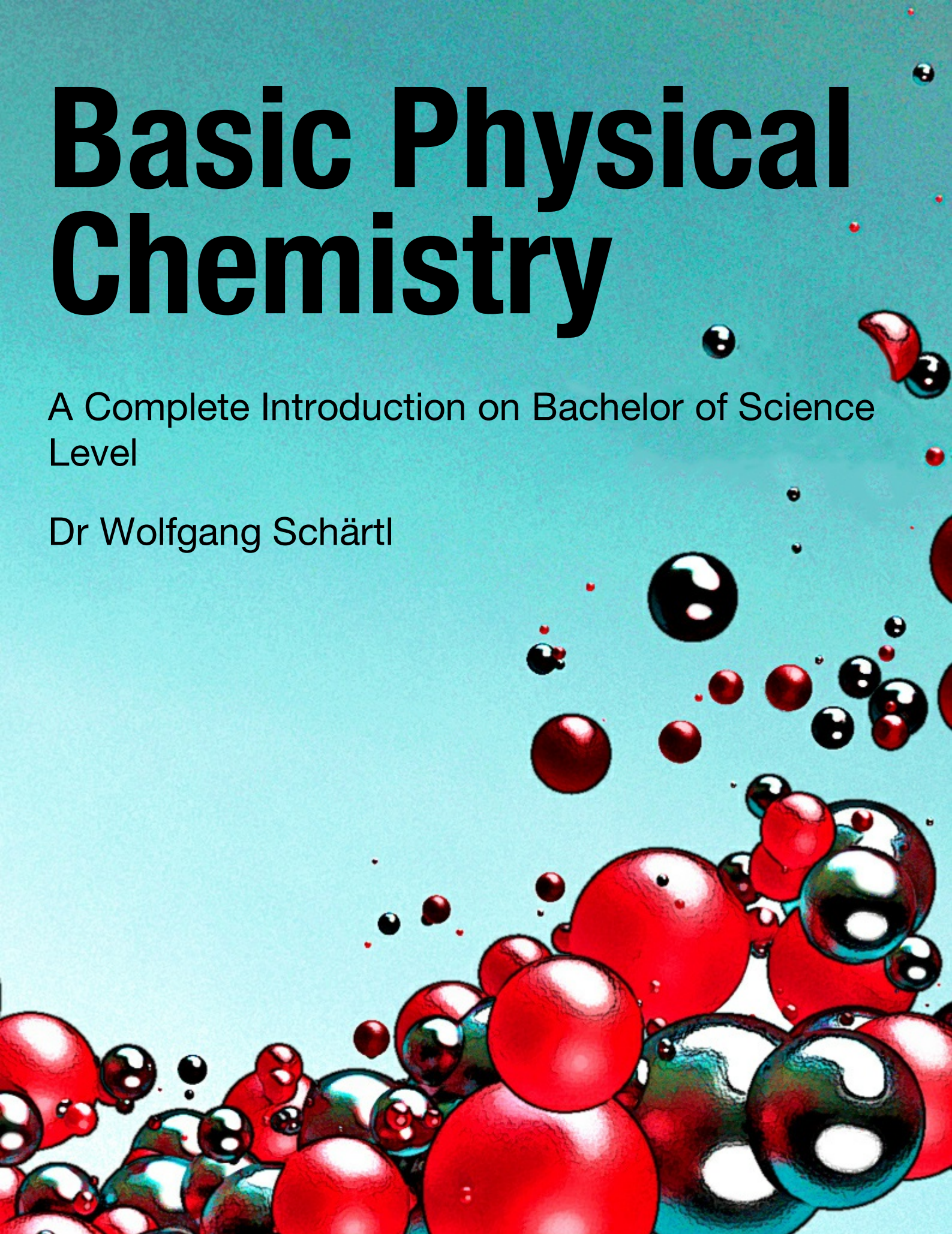

Dr Wolfgang Schärftl

Basic Physical Chemistry

A Complete Introduction on Bachelor of Science Level

Basic Physical Chemistry: A Complete Introduction on Bachelor of Science Level

1st edition

© 2014 Dr Wolfgang Schärfl & bookboon.com

ISBN 978-87-403-0669-9

Contents

	Biography of Dr. Wolfgang Schaertl	6
	Prologue	7
1	Mathematical Basics	9
1.1	Differentials and simple differential equations	9
1.2	Logarithms and trigonometric functions	11
1.3	Linearization of mathematical functions, and Taylor series expansion	12
1.4	Treating experimental data – SI-system and error calculation	14
2	Thermodynamics	17
2.1	Definitions	17
2.2	Gas equations	19
2.3	The fundamental laws of thermodynamics	32
2.4	Heat capacities	47

DESTINATIONS

	GATE	ARRIVAL
INDUSTRY IMPACT	OW	FASTER
GLOBAL ASSIGNMENTS	OW	FASTER
SENIOR CLIENT CONTACT	OW	FASTER
CAREER DEVELOPMENT	OW	FASTER
MAKE PARTNER	OW	FASTER

 **OLIVER WYMAN**



Oliver Wyman is a leading global management consulting firm that combines deep industry knowledge with specialized expertise in strategy, operations, risk management, organizational transformation, and leadership development. With offices in 50+ cities across 25 countries, Oliver Wyman works with the CEOs and executive teams of Global 1000 companies.

**DISCOVER
OUR WORLD**

An equal opportunity employer.

GET THERE FASTER

Some people know precisely where they want to go. Others seek the adventure of discovering uncharted territory. Whatever you want your professional journey to be, you'll find what you're looking for at Oliver Wyman.

Discover the world of Oliver Wyman at oliverwyman.com/careers

 **MARSH & MCLENNAN
COMPANIES**



Click on the ad to read more

2.5	Phase equilibrium	50
2.6	The chemical equilibrium	81
2.7	Reaction energy	85
3	Kinetics	87
3.1	Elementary reactions (one single reaction step, molecularity = order)	89
3.2	The kinetics of more complex multistep chemical reactions	95
3.3	Activation energy	98
4	Electrochemistry	101
4.1	Electric Conductivity	101
4.2	The electrochemical potential and electrochemical cells	120
5	Introduction to Quantum Chemistry and Spectroscopy	133
5.1	Models of the atom	133
5.2	The wave character of matter, or the wave-particle-dualism	138
5.3	Mathematical solutions of some simple problems in quantum mechanics: particle in a box, harmonic oscillator, rotator and the hydrogen atom	145
5.4	A brief introduction to optical spectroscopy	154
	Subject index	164

Day one
and you're ready

Day one. It's the moment you've been waiting for. When you prove your worth, meet new challenges, and go looking for the next one. It's when your dreams take shape. And your expectations can be exceeded. From the day you join us, we're committed to helping you achieve your potential. So, whether your career lies in assurance, tax, transaction, advisory or core business services, shouldn't your day one be at Ernst & Young?

What's next for your future?
ey.com/careers

ERNST & YOUNG
Quality In Everything We Do

© 2010 EYGM Limited. All Rights Reserved.



Biography of Dr. Wolfgang Schaertl

Wolfgang Schaertl was born in 1964 in Celle/Germany. He studied Chemistry at Mainz University from 1984 until 1989, and received his PhD in Chemistry in 1992 for his thesis on video microscopy of fluorescent nanoparticles, and Brownian dynamics computer simulations. As a post-doc, he joined the Hashimoto ERATO project in Kyoto/Japan, where he investigated the structure and dynamics of copolymer micelles in polymer melts. In 1995 he went to Manfred Schmidt at the University of Mainz as a research fellow, where he finished his “habilitation” in 2001 with a thesis on functional core-shell nanoparticles. Since 2005 Wolfgang Schaertl has held a permanent position as lecturer and researcher at Mainz University, Germany. His current research interests include light scattering characterization of nanoparticles, and rheological studies of natural polymer gels (gelatin etc.). Wolfgang Schaertl has published more than 50 refereed publications in international journals, including two frequently cited review papers on nanoparticles. In addition, he has written a textbook about light scattering characterization of polymers and nanoparticles in 2007. Wolfgang Schaertl gives several lectures in Physical Chemistry per term at Mainz University for more than 10 years, covering the whole curriculum in Physical Chemistry for the Bachelor of Education and the Master of Education degrees at Mainz University. Finally, he has also offered many seminars about the theoretical background of the basic and advanced practical courses in Physical Chemistry for the Bachelor of Science.



In the past four years we have drilled

81,000 km

That's more than **twice** around the world.

Who are we?
We are the world's leading oilfield services company. Working globally—often in remote and challenging locations—we invent, design, engineer, manufacture, apply, and maintain technology to help customers find and produce oil and gas safely.

Who are we looking for?
We offer countless opportunities in the following domains:

- Engineering, Research, and Operations
- Geoscience and Petrotechnical
- Commercial and Business

If you are a self-motivated graduate looking for a dynamic career, apply to join our team.

What will you be?

Schlumberger

careers.slb.com

Click on the ad to read more

Prologue

What is Physical Chemistry? Simply spoken, it is a scientific branch located between Physics and Chemistry. By using the principles of physics and mathematics to obtain quantitative relations, physical chemistry deals with the structure and dynamics of matter. These relations are, in most cases, either concerned with phase and chemical equilibrium, or dynamic processes such as phase transitions, reaction kinetics, charge transport, and energy exchange between systems and surroundings.

To describe a physical chemical system and its dynamics or evolution towards an equilibrium state, only a limited set of variables of state is needed: volume, temperature, pressure and amount of material. The equilibrium state itself is based on the simple principle of minimizing the free enthalpy of the system. Free enthalpy is thus one of the most important concepts in physical chemistry. The change of free enthalpy is based on the change of two fundamental quantities: enthalpy which provides a measure for the energy of the system, and entropy which, qualitatively, characterizes the state of order of our system. Before going into too much detail here, let me stress one point to be kept in mind during the study of this book: physical chemistry is based on a small number of fundamental quantities and general physical concepts, which once fully understood by a student, it should be quite easy to pass an examination in physical chemistry without the need to explicitly learn a lot of detailed equations.

This book, which tries to provide a complete overview of physical chemistry on the level of a Bachelor of Science degree in Chemistry, is organized as following:

I already mentioned that physical chemistry deals with the quantitative description of chemical phenomena. Consequently, it affords some knowledge in mathematics. In Chapter 1, I try to briefly introduce all the mathematical concepts needed to understand the formalisms as well as the example problems presented in subsequent other chapters.

Chapter 2, the main part of this book, deals with phenomenological thermodynamics, a topic also most dominant in all lectures in Physical Chemistry on bachelor level. Thermodynamics mainly deals with equilibrium characterized on a macroscopic level by variables of state, such as temperature, pressure or composition of mixtures. Here, the most important aspect related to the preferred equilibrium state of a system is its exchange of energy and entropy with its surroundings. First, a single component system and its phase behavior are discussed to introduce the fundamental concepts. We progress to binary systems and their phase equilibrium, an aspect which is very important for instance in the purification of chemical mixtures by distillation or crystallization. The chapter concludes with the equilibrium of chemical reactions and energetic aspects of chemical reactions.

In Chapter 3, I will briefly discuss the kinetics of chemical reactions. To keep the mathematics simple, only fundamental single-step reactions are treated here. As an example of more complex chemical processes involving multiple reaction steps and chemical equilibrium, this chapter will address the Lindemann formalism and the Michaelis-Menten kinetics, the latter being a very important topic in Biology (enzymatic reactions).

Chapter 4 introduces the two fundamental aspects of electrochemistry: ion mobility and its relation to electrical conductivity, and the electrochemical equilibrium as the basis of the conversion of chemical reaction energy into electrical energy (battery).

Chapter 5, finally, is a brief introduction into quantum chemistry and spectroscopy. Whereas the preceding chapters mainly treat systems on the macroscopic level, ignoring the detailed structure of matter, here it will briefly be shown how atoms and molecules are described in modern physics on a single particle level. Finally, this chapter will also provide a very brief introduction into spectroscopic methods, which are important for the experimental determination of molecular parameters such as bond lengths, strength of a chemical bond, etc.

For illustration of the Physical-Chemical concepts and their relevance, each chapter (2–5) will also contain some quantitative example problems, presented in a box.

1 Mathematical Basics

Physical Chemistry is frequently regarded as mathematically very complicated. Generally, students start with various levels of mathematical knowledge. Therefore, I consider it appropriate to start my book on the basics of physical chemistry with a chapter to briefly introduce the mathematical basics. Besides some technical terms, such as the total differential, in this first chapter of the book the students are introduced, as a refresher on fundamentals, how to solve simple differential equations, use the logarithm in mathematical calculations, use powers and trigonometric functions, as well as how to linearize functions of one variable, and treat physical-chemical data in terms of units or error analysis.

1.1 Differentials and simple differential equations

For example, if $z = f(x,y)$ is a function of the variables x, y , then the total differential of z is given as:

$$dz = \left(\frac{\partial z}{\partial x}\right)_y dx + \left(\frac{\partial z}{\partial y}\right)_x dy \quad (\text{Eq.1.1})$$

So-called “quantities of state”, i.e. basic functions of two variables x, y , fulfill the theorem of Schwarz:

$$\left(\left(\frac{\partial}{\partial x}\right)\left(\frac{\partial}{\partial y}\right)\right)_x = \left(\left(\frac{\partial}{\partial y}\right)\left(\frac{\partial}{\partial x}\right)\right)_y \quad (\text{Eq.1.2})$$

, i.e. the result is independent of the sequence of differentiation, or, alternatively, a change of $z = f(x,y)$ (= change of the quantity of state!) is independent of the route but only depends on the change of the variables x, y !

Examples of such quantities of state are, for example, energy or enthalpy, whereas quantities dependent on the process itself, and therefore not quantities of state, are work or heat.

Since physical chemistry needs just a limited set of simple differentials and integrals, I would like to list the most important ones for basic functions $y(x)$ of one variable x below:

$$y = x^n \rightarrow \frac{dy}{dx} = n \cdot x^{n-1} \rightarrow \int y dx = \frac{1}{n+1} \cdot x^{n+1} \quad (\text{Eq.1.3})$$

$$y = e^x \rightarrow \frac{dy}{dx} = e^x \rightarrow \int y dx = e^x (e = 2.7182818) \quad (\text{Eq.1.4})$$

$$y = e^{k \cdot x} \rightarrow \frac{dy}{dx} = k \cdot e^{k \cdot x} \rightarrow \int y dx = \frac{1}{k} \cdot e^{k \cdot x} \quad (\text{Eq.1.5})$$

$$y = \frac{1}{x^n} \rightarrow \frac{dy}{dx} = -\frac{1}{x^{n+1}} \rightarrow \int y dx = -\frac{1}{(n-1) \cdot x^{n-1}} \quad (\text{Eq.1.6})$$

$$y = \frac{1}{x} \rightarrow \frac{dy}{dx} = -\frac{1}{x^2} \rightarrow \int y dx = \ln(x)(!!!) \quad (\text{Eq.1.7})$$

$$y = \sin x \rightarrow \frac{dy}{dx} = \cos x \rightarrow \int y dx = -\cos x \quad (\text{Eq.1.8})$$

To determine the differential or integral of more complex functions, the following basic rules of differentiation and integration may come handy:

- i. How to differentiate a product (multiplication rule of differentiation):

$$y = u(x) \cdot v(x) \rightarrow \frac{dy}{dx} = u(x) \cdot \frac{dv(x)}{dx} + v(x) \cdot \frac{du(x)}{dx} \quad (\text{Eq.1.9})$$

- ii. How to differentiate a ratio (division rule of differentiation):

$$y = \frac{u(x)}{v(x)} \rightarrow \frac{dy}{dx} = \frac{-u(x) \frac{dv(x)}{dx} + v(x) \frac{du(x)}{dx}}{v(x)^2} \quad (\text{Eq.1.10.})$$

- iii. Partial Integration:

$$y = u(x) \cdot \frac{dv(x)}{dx} \rightarrow \int y dx = u(x) \cdot v(x) - \int v(x) \cdot \frac{du(x)}{dx} dx \quad (\text{Eq.1.11})$$

Next, let us solve a couple of simple differential equations, i.e. determine the function itself if the differential is given. Note that these two examples will be found again in the chapter on reaction kinetics:

Example 1:

$$\frac{dy}{dx} = -k \cdot y \quad (\text{Eq. 1.12})$$

To solve this equation, we first have to separate the two variables x , y :

$$\frac{dy}{y} = -k \cdot dx \quad (\text{Eq. 1.13})$$

Next, we have to determine the integrals, using a set of starting variables x_0, y_0 and arbitrary variables x , y as respective boundaries:

$$\int_{y_0}^y \frac{1}{y} dy = \int_{x_0}^x -k \cdot dx \quad (\text{Eq.1.14})$$

$$\int_{y_0}^y [\ln y] = \int_{x_0}^x [-k \cdot x] \quad (\text{Eq.1.15})$$

$$\ln y - \ln y_0 = -k \cdot x + k \cdot x_0 \quad (\text{Eq.1.16})$$

$$y = y_0 \cdot \exp(-k \cdot (x - x_0)) \quad (\text{Eq.1.17})$$

Note that $\exp(x)$ corresponds to e^x ! This example will be used again when we discuss first order basic reaction kinetics.

Example 2:

$$\frac{dy}{dx} = -k \cdot y^2 \quad (\text{Eq.1.18})$$

To solve this equation, again we first have to separate the two variables x , y :

$$\frac{dy}{y^2} = -k \cdot dx \quad (\text{Eq.1.19})$$

Analogous to example 1, we then have to determine the integrals, using a set of starting variables x_0, y_0 and arbitrary variables x , y as respective boundaries:

$$\int_{y_0}^y \frac{1}{y^2} dy = \int_{x_0}^x -k \cdot dx \quad (\text{Eq.1.20})$$

$$\int_{y_0}^y \left[-\frac{1}{y}\right] = \int_{x_0}^x [-k \cdot x] \quad (\text{Eq.1.21})$$

$$-\frac{1}{y} + \frac{1}{y_0} = -k \cdot x + k \cdot x_0 \quad (\text{Eq.1.22})$$

This example will be used again when we discuss second order basic reaction kinetics.

Within the context of this book, we will not need to solve more complex differential equations as shown here. However, the interested reader should keep in mind that there exist a variety of strategies to address more complex differential equations as might be encountered in a lecture on advanced physical chemistry, e.g. in quantum mechanics or complex reaction kinetics. Just to name one of these mathematical methods: partial fraction analysis:

$$\int \frac{1}{(a-x) \cdot (b-x)} dx = \int \frac{c_1}{(a-x)} dx + \int \frac{c_2}{(b-x)} dx \quad (\text{Eq.1.23})$$

We will briefly sketch this method later in the book when we discuss the exact kinetics of 2nd order reactions of two different chemical components.

1.2 Logarithms and trigonometric functions

Besides simple differential equations, in physical chemical calculations and derivations of important formulae it is essential that the student is capable of the logarithm rules as well as that he/she can handle trigonometric functions. These are therefore summarized in this subchapter.

$$e^{a+b} = e^a \cdot e^b \leftrightarrow \ln(a \cdot b) = \ln a + \ln b \quad (\text{Eq.1.24})$$

$$e^{a-b} = \frac{e^a}{e^b} \leftrightarrow \ln\left(\frac{a}{b}\right) = \ln a - \ln b \quad (\text{Eq.1.25})$$

$$(e^a)^b = e^{a \cdot b} \leftrightarrow \ln(a^b) = b \cdot \ln a \quad (\text{Eq.1.26})$$

$$\sin^2 \alpha + \cos^2 \alpha = 1 \quad (\text{Eq.1.27})$$

$$\sin \alpha = \cos(90^\circ - \alpha) \quad (\text{Eq.1.28})$$

$$\sin(\alpha + \beta) = \sin \alpha \cdot \cos \beta + \cos \alpha \cdot \sin \beta \quad (\text{Eq.1.29})$$

$$\cos(\alpha + \beta) = \cos \alpha \cdot \cos \beta - \sin \alpha \cdot \sin \beta \quad (\text{Eq.1.30})$$

1.3 Linearization of mathematical functions, and Taylor series expansion

In some cases, a plot of the function $y(x)$ can simply be linearized if the reverse function is used, for example:

$$y = y_0 \cdot \exp(-k \cdot x) \leftrightarrow \ln y = \ln y_0 - k \cdot x \quad (\text{Eq.1.31})$$



Hellmann's is one of Unilever's oldest brands having been popular for over 100 years. If you too share a passion for discovery and innovation we will give you the tools and opportunities to provide you with a challenging career. Are you a great scientist who would like to be at the forefront of scientific innovations and developments? Then you will enjoy a career within Unilever Research & Development. For challenging job opportunities, please visit www.unilever.com/rdjobs.

Could it be 
Unilever



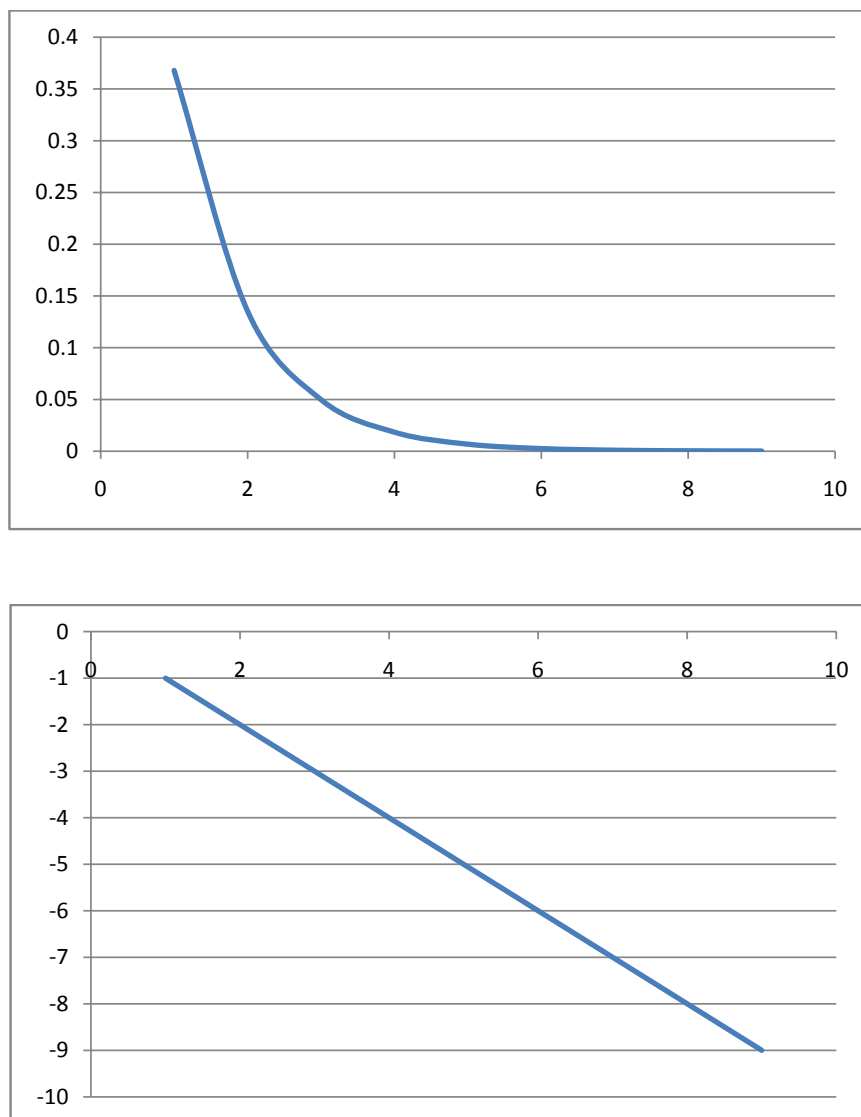

Figure 1.1: Linearization of an exponential (top) by plotting the logarithm (bottom) (Plots were prepared using Microsoft Excel (MS Office 2007))

Any function can be linearized if you use the Taylor series expansion given as:

$$y(x_0 + x) = y(x_0) + \left(\frac{dy}{dx}\right)_{x_0} \cdot (x - x_0) + \frac{1}{2!} \cdot \left(\frac{d^2y}{dx^2}\right)_{x_0} \cdot (x - x_0)^2 + \frac{1}{3!} \cdot \left(\frac{d^3y}{dx^3}\right)_{x_0} \cdot (x - x_0)^3 + \dots \quad (\text{Eq.1.32})$$

One important (and the only!) example for a Taylor series expansion we use in this textbook concerns the logarithm, i.e.:

$$\ln(1 - x) = \ln 1 + \left(\frac{-1}{1-x}\right)_{x_0=0} \cdot (x - 0) + \frac{1}{2!} \cdot \left(\frac{-1}{(1-x)^2}\right)_{x_0=0} \cdot (x - 0)^2 + \dots \approx -x \quad (\text{Eq.1.33})$$

For small x , the logarithm $\ln(1 - x)$ is simply given by $-x$, a relation we will use for instance to obtain quite simple formulae for colligative phenomena in dilute solutions.

1.4 Treating experimental data – SI-system and error calculation

(A) Units – the SI-system:

The standard system of physical units (system international (French), SI) contains only a limited number, namely kg (kilogram) for mass, m (meter) for length, s (second) for time, A (Ampere) for charge per time (= electric current), and K (Kelvin) for (absolute) temperature. All other units can be expressed in terms of these basic units, and any student of science should be capable of this, since it comes in handy in (i) deriving simple formulae, (ii) understanding physical quantities, and (iii) calculating quantities based on certain variables. As one important example, let us consider several ways of expressing energy:

- 1) potential energy equals force times length, and force is acceleration times mass, therefore energy should be: $\text{kg m s}^{-2} \text{ m} = \text{kg m}^2 \text{ s}^{-2} = \text{J}$ (Joule)
- 2) alternatively, energy is power times time, therefore W s (or, not SI, but more common: kWh)
- 3) in electrostatics, energy is voltage times charge, therefore A s V (or keV (kilo electron Volt, not SI, with the elementary charge $1 e = 1.6 \cdot 10^{-19} \text{ A s}$))

The most common derived SI units are: N (Newton) for force, Pa (Pascal) for pressure, J (Joule) for energy, W (Watt) for power, C (Coulomb) for electric charge, V (Volt) for voltage, Ω (Ohm) for electric resistance.

(B) Error calculation:

Experimental data are not perfect, that is, even if you repeat a given experiment several times, you will get at least slightly different results. If $x_1, x_2, x_3, \dots, x_N$ is a set of these different results obtained from a total of N single measurements, these data are evaluated as following:

First, one has to calculate the average of the experimental quantity x , i.e.

$$\langle x \rangle = \frac{1}{N} \sum_{i=1}^N x_i \quad (\text{Eq.1.34})$$

To determine the reliability of this average, we then have to calculate the standard deviation. The apparent error of a single experiment is given as $\Delta x_i = \langle x \rangle - x_i$, and the standard deviation then is obtained by averaging the absolute values of all apparent errors, i.e.

$$S = \sqrt{\frac{\sum_{i=1}^N \Delta x_i^2}{N-1}}, \text{ with } N > 1 \quad (\text{Eq. 1.35})$$

Finally, our experimental result is more reliable the larger the number of individual measurements N , which is taken into account within the statistical error of the average quantity $\langle x \rangle$ calculated from the standard deviation as:

$$\Delta x = \sqrt{\frac{S^2}{N}} = \sqrt{\frac{\sum_{i=1}^N \Delta x_i^2}{N \cdot (N-1)}} \quad (\text{Eq.1.36})$$

Within a written report of the experiment, the result must then be given as $x = \langle x \rangle \pm \Delta x$, providing both the average and the reliability.

(C) Error progression:

In most experiments, a given physical quantity depending on several individually measured parameters has to be calculated. As one example, let us consider a quantity z depending on two parameters x, y , that is $z = f(x, y)$. In this case, the calculated error of z depends on the statistical errors of the two physical parameters x, y as following (error progression):

$$\Delta z = \left(\frac{dz}{dx} \right)_{\langle x \rangle, \langle y \rangle} \cdot \Delta x + \left(\frac{dz}{dy} \right)_{\langle x \rangle, \langle y \rangle} \cdot \Delta y \quad (\text{Eq.1.37})$$

Note that the derivatives could be positive or negative, and therefore partially compensate each other, which does not make much sense. Therefore, one has to calculate the absolute values, i.e.

$$\Delta z^2 = \left(\frac{dz}{dx} \right)_{\langle x \rangle, \langle y \rangle}^2 \cdot \Delta x + \left(\frac{dz}{dy} \right)_{\langle x \rangle, \langle y \rangle}^2 \cdot \Delta y, \quad (\text{Eq.1.38})$$

or

$$\Delta z = \sqrt{\left(\frac{dz}{dx} \right)_{\langle x \rangle, \langle y \rangle}^2 \cdot \Delta x + \left(\frac{dz}{dy} \right)_{\langle x \rangle, \langle y \rangle}^2 \cdot \Delta y} \quad (\text{Eq.1.39})$$



Discover the truth at www.deloitte.ca/careers

Deloitte.

© Deloitte & Touche LLP and affiliated entities.



As we have seen before, often physical-chemical data are represented in a linear relation, and the intercept and the slope provide the quantities of interest. To determine the error of this linear analysis, formally linear regression has to be used. This requires plugging all of your individual data points into the computer, and trusting the numerical calculation of the errors of intercept and slope. Additionally simple linear regression might ignore the statistical errors of individual data points. In practice the following approach is much more convenient and reliable.

First, plot all your data points considering the statistical errors of each individual point (= error bars), respectively. 2nd, draw two extreme lines which contain all data points with error bars, as well as an intermediate line. From this simple picture, you then can determine average slope and intercept, as well as the error of these two. The procedure is illustrated in figure 2.

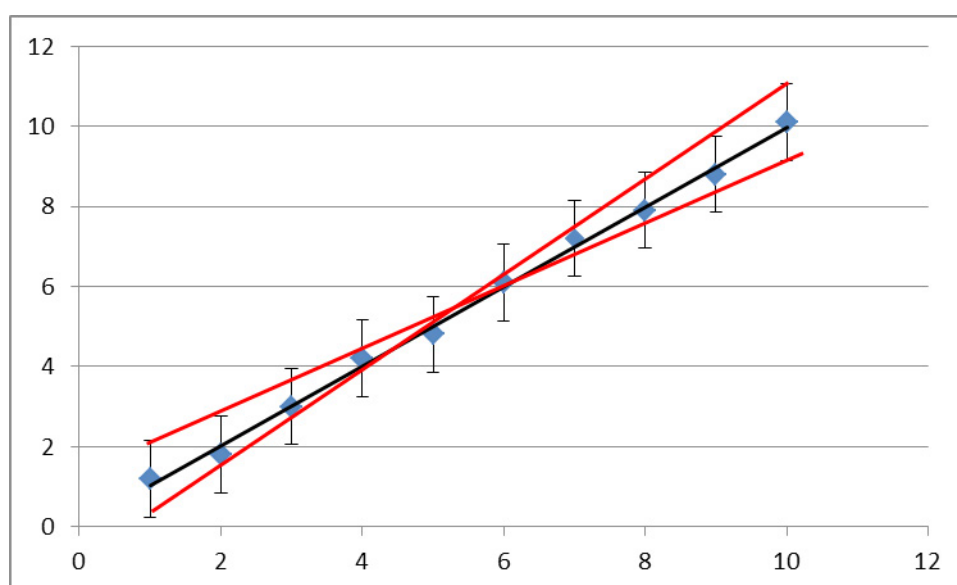

Figure 2: Graphical linear regression of data points including error bars
(Plot was prepared using Microsoft Excel (MS Office 2007))

2 Thermodynamics

Phenomenological thermodynamics is mainly concerned with equations and variables of state, energy exchange at physicochemical processes, and phase- and chemical equilibrium. The goal of this chapter is to give a complete overview of all important concepts used in phenomenological thermodynamics, and provide some illustrative examples when appropriate.

We will start with some basic definitions concerning physico-chemical systems and processes, then introduce the ideal and real gas equations of state, and finally discuss the fundamental principles of thermodynamics. Here, physical models for the heat capacity of ideal gases and solids will allow us to calculate the energy, heat and work exchange for any given process, even cycles such as the Carnot process.

Next, the phase equilibrium of both pure components and binary mixtures will be addressed. For the latter, in the case of high dilution, simple formula for so-called colligative phenomena such as lowering of the freezing temperature, increase of the evaporation temperature, or osmotic pressure will be derived and discussed. Finally, we will talk about the equilibrium of chemical reactions, as well as about energetic aspects of chemical reactions.

2.1 Definitions

In thermodynamics, systems are classified according to their ability to exchange matter and/or energy with their environment:

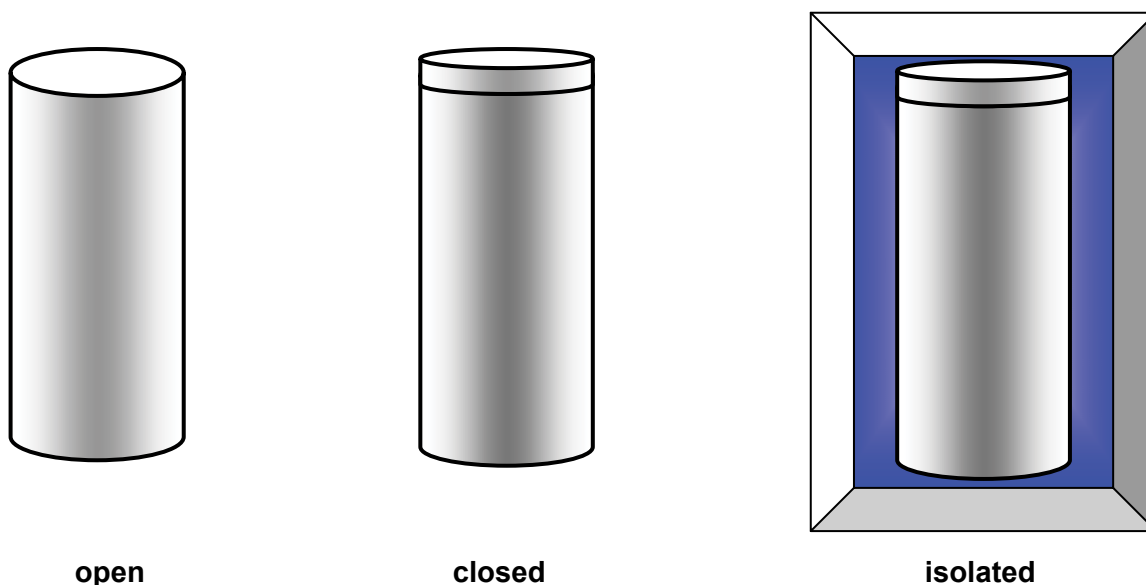

Fig. 2.1: definitions of physical-chemical systems

An example for an open system, which can exchange both matter and energy with the environment, is an open beaker filled with boiling water (heat is lost to the environment, and matter is lost due to evaporation of water), whereas an example for a closed system would be a pot of boiling water tightly closed with a lid (only heat is lost). An isolated system would be, for instance, a closed thermostat bottle filled with hot tea: neither energy nor matter is exchanged with the environment.

On the other hand, physico-chemical processes are classified as following: 1. Isochor, i.e. the volume of the system is kept constant ($dV = 0$), 2. Isobar, i.e. the pressure is kept constant ($dp = 0$), 3. Isotherm, i.e. the temperature is kept constant ($dT = 0$), or 4. Adiabatic, i.e. no exchange of heat with the environment ($Q = 0$).

Finally, we have to consider the different aggregate states of matter: solid (defined volume and shape), liquid (defined volume, undefined shape), and gas (neither volume nor shape is defined)

Grant Thornton—^{REALLY} a great place to work.

We're proud to have been recognized as one of Canada's Best Workplaces by the Great Place to Work Institute™ for the last four years. In 2011 Grant Thornton LLP was ranked as the fifth Best Workplace in Canada, for companies with more than 1,000 employees. We are also very proud to be recognized as one of Canada's top 25 Best Workplaces for Women and as one of Canada's Top Campus Employers.



Priyanka Sawant
Manager



Audit • Tax • Advisory
www.GrantThornton.ca/Careers



Grant Thornton
An instinct for growth™

© Grant Thornton LLP. A Canadian Member of Grant Thornton International Ltd



2.2 Gas equations

2.2.1 The ideal gas

In 1679, Boyle and Mariotte found experimentally that for a gas undergoing an isothermal process (either compression or expansion) its volume times its pressure remain constant:

$$p \cdot V = \text{const} \quad (\text{Eq.2.1})$$

, namely 22.12 l bar for 1 mole gas at temperature $t = 0 \text{ }^\circ\text{C}$.

In 1800, Gay-Lussac discovered that for isobaric or isochoric processes, the volume or the pressure of a gas, respectively, increases linearly with temperature:

$$\text{1st law of Gay-Lussac:} \quad V = V_0 \cdot (1 + \alpha_0 \cdot t) \quad (\text{Eq.2.2})$$

Here, V_0 is the volume of the gas at standard conditions ($p = 1.013 \text{ bar}$, $t = 0^\circ\text{C}$). Importantly, different gases all have the same normalized thermal expansion coefficient:

$$\alpha_0 = \frac{\left(\frac{\Delta V}{V_0}\right)}{\Delta t} = \frac{1}{273.16} \text{ }^\circ\text{C} \quad (\text{Eq.2.3})$$

, and we obtain therefore:

$$V = V_0 \cdot \left(1 + \frac{t}{273.16}\right) = V_0 \cdot \left(\frac{273.16+t}{273.16}\right) = V_0 \cdot \alpha_0 \cdot T \quad (\text{Eq.2.4})$$

Here, T is a new temperature scale with unit ‘Kelvin’. Both scales can simply be converted into each other according to $T/[K] = t/[\text{ }^\circ\text{C}] + 273.16$. Note that, for the description of the isochoric processes of the ideal gas the Kelvin scale is more convenient, since simple proportionality is obtained. Also, since no negative volume can exist, it is obvious that $T = 0 \text{ K}$ (or $t = -273.16 \text{ }^\circ\text{C}$) is the smallest temperature possible. Therefore, the Kelvin scale is also called the scale of absolute temperature, whereas the Celsius scale is based on the properties of one specific chemical, water, which freezes under standard pressure at $t = 0 \text{ }^\circ\text{C}$, and boils at $100 \text{ }^\circ\text{C}$.

For the isochoric process, in analogy the 2nd law of Gay-Lussac can be formulated:

$$\text{2nd law of Gay-Lussac:} \quad p = p_0 \cdot (1 + \beta_0 \cdot t) \quad (\text{Eq.2.5})$$

Here, p_0 is the pressure of the gas at standard conditions ($p = 1.013 \text{ bar}$, $t = 0^\circ\text{C}$). Importantly, again different gases all have the same normalized thermal compressibility coefficient:

$$\beta_0 = \frac{\left(\frac{\Delta p}{p_0}\right)}{\Delta t} = \frac{1}{273.16} \text{ }^\circ\text{C} \quad (\text{Eq.2.6})$$

and we obtain therefore:

$$p = p_0 \cdot \left(1 + \frac{t}{273.16}\right) = p_0 \cdot \left(\frac{273.16+t}{273.16}\right) = p_0 \cdot \beta_0 \cdot T \quad (\text{Eq.2.7})$$

To obtain the general equation of state of the ideal gas irrespective of the process, we next combine the laws of Boyle, Mariotte and Gay-Lussac, using formally a two-step process to change from a given set of state variables (p_0, V_0, T_0) to a completely different set of variables (p_1, V_1, T_1) :

$$(p_0, V_0, T_0) \xrightarrow{dT=0} (p_1, V_x, T_0) \xrightarrow{dp=0} (p_1, V_1, T_1) \quad (\text{Eq.2.8})$$

For the first isotherm step we use the law of Boyle, Mariotte to express the unknown volume V_x :

$$p_1 \cdot V_x = p_0 \cdot V_0 \quad \rightarrow \quad V_x = V_0 \cdot \frac{p_0}{p_1} \quad (\text{Eq.2.9})$$

For the 2nd isobar step we used the first law of Gay-Lussac, i.e.:

$$V \sim T \quad \rightarrow \quad \frac{V_1}{T_1} = \frac{V_x}{T_0} \quad \rightarrow \quad V_x = \frac{V_1}{T_1} \cdot T_0 \quad (\text{Eq.2.10})$$

We then can replace V_x in (Eq.2.9), and finally obtain:

$$\frac{V_1}{T_1} \cdot T_0 = V_0 \cdot \frac{p_0}{p_1} \quad \rightarrow \quad \frac{p_1 \cdot V_1}{T_1} = \frac{p_0 \cdot V_0}{T_0} \quad (\text{Eq.2.11})$$

Since our starting conditions “0” as well as our final state “1” have been chosen arbitrarily, we can conclude that:

$$\frac{p_1 \cdot V_1}{T_1} = \text{const} \quad (\text{Eq.2.12})$$

According to experimental observations, this constant is given by the amount of gas in mole n , and the universal gas constant = 8.314 J/(mole K), and one obtains the universal law of ideal gases:

$$p \cdot V = n \cdot R \cdot T \quad (\text{Eq.2.13})$$

Example 2.1.:

Consider a small lab (20 m² area, height 3 m), where an automatic CO₂-fire extinguisher, during a sudden fire in one of the hoods, suddenly releases 10 kg of CO₂. What is the effective mass per m² acting on the windows of the lab due to the suddenly increased pressure (use the ideal gas equation of state for approximation)?

Solution: The 10 kg of CO₂ (M = 44 g/Mol) correspond to 10000/44 = 227.3 Mol gas. The corresponding additional pressure therefore is

$$p_{CO_2} = \frac{n \cdot R \cdot T}{V} = \frac{227.3 \cdot 8.314 \cdot 293}{20 \cdot 3} \text{ Pa} = 9228 \text{ Pa} = 9228 \frac{\text{N}}{\text{m}^2}$$

The effective additional mass per m² corresponding to this excess pressure is then given by

$$F = m \cdot g \quad \Rightarrow \quad 9228 \text{ N} = m \cdot 9.81 \frac{\text{N}}{\text{kg}} \quad \Rightarrow \quad m = 940.7 \text{ kg}$$

Therefore, nearly 1 ton acts on 1 m² of our lab windows, so most likely the windows will explode.

The Wake

the only emission we want to leave behind

Low-speed Engines Medium-speed Engines Turbochargers Propellers Propulsion Packages PrimeServ

The design of eco-friendly marine power and propulsion solutions is crucial for MAN Diesel & Turbo. Power competencies are offered with the world's largest engine programme – having outputs spanning from 450 to 87,220 kW per engine. Get up front! Find out more at www.mandieselturbo.com

Engineering the Future – since 1758.

MAN Diesel & Turbo



Note that the ideal gas law (Eq.2.13) should be considered as a phenomenological law which is confirmed by experience, but it provides no explanation in terms of microscopic molecular motions. In the next section “kinetic gas theory” we will therefore discuss the ideal gas based on a microscopic single particle-based description developed by Maxwell, Boltzmann and others in the 19th century.

2.2.2 Kinetic Gas Theory

For the microscopic description of the ideal gas, we consider particles with mass m but no volume, which move without interactions in a strictly ballistic way between the rigid walls of a cubic sample container with side length a . Further, the number of gas particles is very large, so we can apply Boltzmann statistics. Note that a detailed derivation of the Boltzmann distribution is beyond the scope of this book, so we refer the reader to any common text book, section “statistical thermodynamics”.

For this ideal gas system, the velocity distribution as a function of sample temperature and single gas particle mass m is then given, according to Maxwell and Boltzmann, as:

$$f(u) \cong \left(\frac{m}{2k_B T}\right)^{1.5} \cdot u^2 \cdot \exp\left[-\frac{m/2 \cdot u^2}{k_B T}\right] \quad (\text{Eq.2.14})$$

It should be noted here that the exponential in this expression corresponds to the Boltzmann factor. Here, the Boltzmann constant is given as $k_B = 1.38 \cdot 10^{-23} \text{ J/s}$. According to the Boltzmann factor, states of lower energy have a higher statistical probability of being occupied by the particles, as shown in figure 2.2. Multiplying this factor with the term u^2 , which is introduced in Eq.(2.14) due to a spatial integral over all possible directions of particle motion, one obtains a maximum velocity, which in dependence of temperature is shifted to higher values (see figure 2.3).

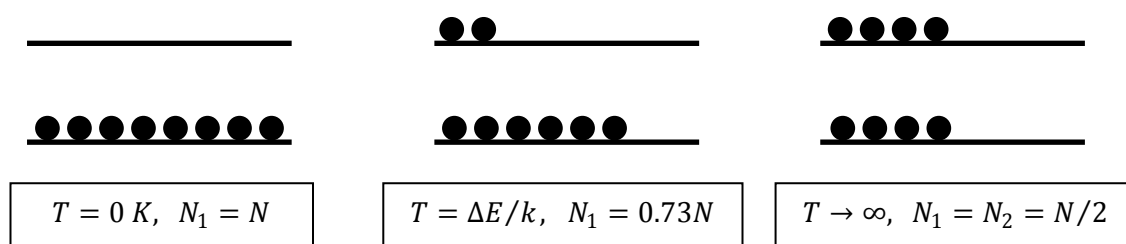

Fig. 2.2.: Boltzmann distribution at different T, 2-state-system

In general, the ratio of occupation probability of an energetically excited state N_2 compared to the occupation probability of the ground state N_1 according to the Boltzmann factor depends on temperature and energy difference $E_2 - E_1 = \Delta E$ as:

$$\frac{N_2}{N_1} = \exp\left[-\frac{E_2 - E_1}{k_B T}\right] = \exp\left[-\frac{\Delta E}{k_B T}\right] \quad (\text{Eq.2.15})$$

Contrary to Fig. 2.2., our ideal gas particles in principle can assume any velocity and not just a quantized set of discrete values. However, the Boltzmann factor itself is not necessarily restricted to quantized energy states, but describes any probability ratio of populations $\frac{N_2}{N_1}$ separated in energy by ΔE .

We will meet this extremely important concept of the Boltzmann factor more frequently throughout this book. Here, let me just name one analogous example from kinetics, the well-known Arrhenius-equation:

$$k = A \cdot \exp \left[-\frac{E_A}{k_B T} \right] \quad (\text{Eq.2.16})$$

with k the reaction velocity constant, and E_A the energy of activation. The exponential term here describes the probability to reach the excited state via thermal excitation at temperature T .

Coming back to our ideal gas treated on a microscopic level, let us discuss the shape of the Maxwell-Boltzmann velocity distribution at different temperatures in more detail:

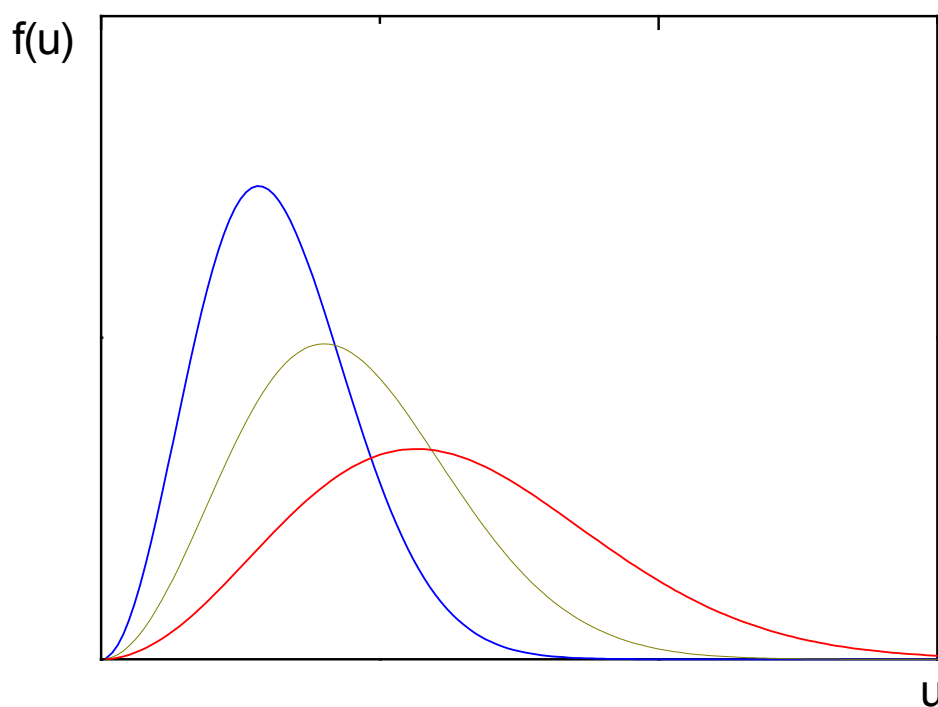

Fig. 2.3.: Maxwell-Boltzmann velocity distribution at different temperatures (from cold (blue) to hot (red))

With increasing temperature, the maximum is shifted towards higher velocities, and the distribution becomes much broader.

The expression for the velocity distribution (Eq.2.14) allows us to calculate an analytical expression of the average squared velocity of a single particle as a function of sample temperature. We also need a relation between this average squared velocity and the macroscopic pressure to discuss the equation of state of the ideal gas in terms of microscopic molecular motions. Pressure is force per area, and force is the time derivative of the momentum, which itself is mass times velocity. Therefore, the pressure enacted by a single gas particle colliding with one wall of our cubic box is given as:

$$p = \frac{F}{A} = \frac{\left(\frac{d(m \cdot u_x)}{dt}\right)}{a_x^2} \quad (\text{Eq.2.17})$$

The momentum of this particle is only changed at the collision, where it is reverted. Further, the time between two collisions is given by the velocity and the distance, and we therefore can express the momentum change with time as:

$$\left(\frac{d(m \cdot u_x)}{dt}\right) = \frac{\Delta(m \cdot u_x)}{\Delta t} = \frac{m \cdot u_x - (-m \cdot u_x)}{2 \cdot l_x / u_x} = \frac{m \cdot u_x^2}{l_x} \quad (\text{Eq.2.18})$$

For all particles within our cubic box, the overall momentum transfer related to the pressure is given by summing up the individual effects and replacing the squared velocity of the single particle with the average quantity:

$$p = \frac{F}{A} = \frac{\sum \frac{m \cdot \langle u_x^2 \rangle}{l_x}}{l_x^2} = N \cdot \frac{m \cdot \langle u_x^2 \rangle}{l_x^3} \quad (\text{Eq.2.19})$$



CAREER KICKSTART

An app to keep you in the know

Whether you're a graduate, school leaver or student, it's a difficult time to start your career. So here at RBS, we're providing a helping hand with our new Facebook app. Bringing together the most relevant and useful careers information, we've created a one-stop shop designed to help you get on the career ladder – whatever your level of education, degree subject or work experience.

And it's not just finance-focused either. That's because it's not about us. It's about you. So download the app and you'll get everything you need to know to kickstart your career.

So what are you waiting for?

Click [here](#) to get started.



or

$$p \cdot V = N \cdot m \cdot \langle u_x^2 \rangle \quad (\text{Eq.2.20})$$

Since all directions x, y and z have the same probability, the average squared velocity in 3d is given as

$$\langle u^2 \rangle = \langle u_x^2 \rangle + \langle u_y^2 \rangle + \langle u_z^2 \rangle = \frac{1}{3} \cdot \langle u_x^2 \rangle \quad (\text{Eq.2.21})$$

leading to

$$p \cdot V = N \cdot m \cdot \frac{\langle u^2 \rangle}{3} \quad (\text{Eq.2.22})$$

According to the Maxwell-Boltzmann distribution (Eq.(2.14)), the average squared velocity of the particles can be calculated, corresponding to an average kinetic energy per particle of

$$\frac{1}{2} \cdot m \cdot \langle u^2 \rangle = \frac{3}{2} \cdot k_B \cdot T \quad (\text{Eq.2.23})$$

Therefore, for a total number of gas particles $N_A = 6.02 \cdot 10^{23}$, we obtain:

$$p \cdot V = N \cdot m \cdot \frac{\langle u^2 \rangle}{3} = N_A \cdot k_B \cdot T = R \cdot T \quad (\text{Eq.2.24})$$

with the gas constant given as $R = N_A \cdot k_B = 8.314 \text{ J}/(\text{mole} \cdot \text{K})!$

Example 2.2.:

Calculate the mean squared velocity of nitrogen molecules at room temperature, and compare your result to the velocity of sound.

Solution: We simply use the mass per molecule $m = 28 \text{ g}/N_A$, and the following expression

$$\frac{1}{2} \cdot m \cdot \langle u^2 \rangle = \frac{3}{2} \cdot k_B \cdot T \quad \Rightarrow \quad \langle u^2 \rangle = \frac{3 \cdot k_B \cdot T}{m} = \frac{3 \cdot 1.38 \cdot 10^{-23} \cdot 293 \text{ m}^2}{0.028 / 6.02 \cdot 10^{23} \text{ s}^2} = 260799 \frac{\text{m}^2}{\text{s}^2}$$

Therefore, the mean velocity is

$$\sqrt{\langle u^2 \rangle} = \sqrt{260799} \frac{\text{m}}{\text{s}} = 510.7 \frac{\text{m}}{\text{s}}$$

Our result agrees well with the velocity of sound = 300 m/s. Note that in case of a sound wave a very large number of mainly nitrogen molecules has to move in the same direction. Therefore, this group velocity, i.e. the velocity of sound = 300m/s, has to be smaller than the statistical velocity of individual molecules.

2.2.3 Real Gases, isotherms and critical conditions

For ideal gases, we ignored the particle volume as well as interparticle interactions, whereas in reality gas particles are molecules or atoms which possess both characteristics. The interactive forces are either caused by permanent dipoles or by fluctuating dipoles which depend on polarizability of a given molecule. For example, in the case of noble gases the fluctuating dipoles increase from He to Xe resulting in greater strength of attractive forces. To take these effects into account, we reformulate the ideal gas equation of state into the so-called Van-der-Waals-equation:

$$\left(p + \frac{n^2 \cdot a}{V^2}\right) \cdot \left(\frac{V}{n} - b\right) = (p + \pi) \cdot \left(\frac{V}{n} - b\right) = R \cdot T \quad (\text{Eq.2.25 a})$$

or, with $v = \frac{V}{n}$ the molar volume:

$$\left(p + \frac{a}{v^2}\right) \cdot (v - b) = (p + \pi) \cdot (v - b) = R \cdot T \quad (\text{Eq.2.25 b})$$

Note that the pressure the real gas enacts on the wall of a container, compared to the ideal gas, is reduced due to the attractive forces, i.e. $p_{re} = p_{id} - \pi < p_{id}$, whereas the sample volume itself is increased by the molar particle volume, i.e. $v_{re} = v_{id} + b > v_{id}$. If you compare the ideal gas and the real gas laws at identical $R \cdot T$, this means that: (i) the external pressure to keep the volume of the ideal gas constant has to be higher than in case of the real gas, and (ii) at given container volume V the sample volume accessible by the gas particles is larger for ideal gases than for real gases. The excluded volume b corresponds effectively to a short-range repulsive interparticle interaction. For spherical gas particles, like noble gas atoms, it can be simply calculated from the single particle volume according to the following sketch:

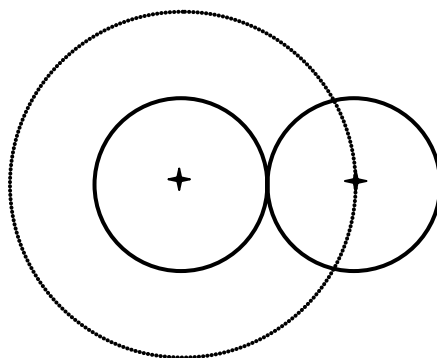

Fig. 2.3.: Excluded volume for one pair of spherical gas particles

In Fig. 2.3., the dotted circle corresponds to the excluded spherical volume which contains only a single particle at once. This volume is defined by two spherical particles at closest contact, and therefore has a radius of twice the single particle radius, and correspondingly eight times the single particle volume. In conclusion, since the sketch holds for two particles which exclude each other, the excluded volume per single particle corresponds to four times the particle volume, i.e. $b = 4 \cdot V_{Atom}$.

The overall interaction between two real gas particles is described by the interaction pair potential sketched in figure 2.4. or

$$E(\sigma) = 4 \cdot \varepsilon \cdot \left[\left(\frac{\sigma_m}{\sigma} \right)^{12} - \left(\frac{\sigma_m}{\sigma} \right)^6 \right] \quad (\text{Eq.2.26})$$

ORACLE®

Be BRAVE

enough to reach for the sky

Oracle's business is information - how to manage it, use it, share it, protect it. Oracle is the name behind most of today's most innovative and successful organisations.

Oracle continuously offers international opportunities to top-level graduates, mainly in our Sales, Consulting and Support teams.

If you want to join a company that will invest in your future, Oracle is the company for you to drive your career!

<https://campus.oracle.com>



ORACLE®

ORACLE IS THE INFORMATION COMPANY



Click on the ad to read more

In Fig. 2.4., the parameter σ_m corresponds to the interparticle distance σ where attractive and repulsive interaction energy compensate exactly, whereas the minimum position in the figure corresponds to the stable state with maximum net attraction. Therefore, σ_m is a measure of the particle size of excluded volume (see van-der-Waals-Eq.). Note that the depth of this minimum is parameterized by ϵ . This parameter therefore provides a measure for the attractive interparticle forces or the internal pressure of the van-der-Waals-Eq. In the Eq.(2.26), one should also note that the attractive interaction energy based on dipole-dipole-attraction scales with inverse interparticle distance to the power of 6, whereas the repulsive interaction caused by direct overlap of the electron clouds of neighboring particles has a much shorter range and scales with inverse interparticle distance to the power of 12. Here, one should recall that the attractive Coulomb interaction energy between a positive and a negative charge scales with $1/\sigma$, and therefore has a much longer range than dipole-dipole-attraction.

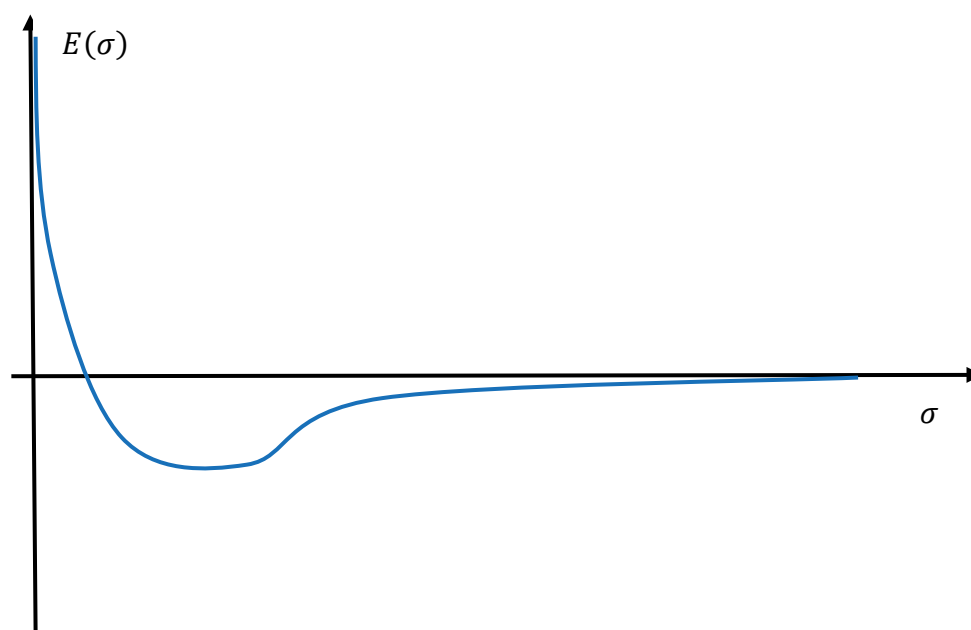

Fig. 2.4.: Interaction pair potential of real gas particles

Both internal pressure and excluded volume have a strong effect on the shape of the isotherms of a real gas. Whereas the isotherm of the ideal gas at all temperatures according to Boyle, Mariotte (see above) is a simple hyperbolic function, the van-der-Waals Eq. allows for three different typical shapes of isotherms: above the critical temperature, the isotherms are similar to those of an ideal gas, and simply hyperbolic. At the critical temperature, the isotherm shows a turning point with slope zero, the critical point, whereas at lower temperature the isotherms show, with decreasing pressure and increasing volume, first a minimum and then a maximum.

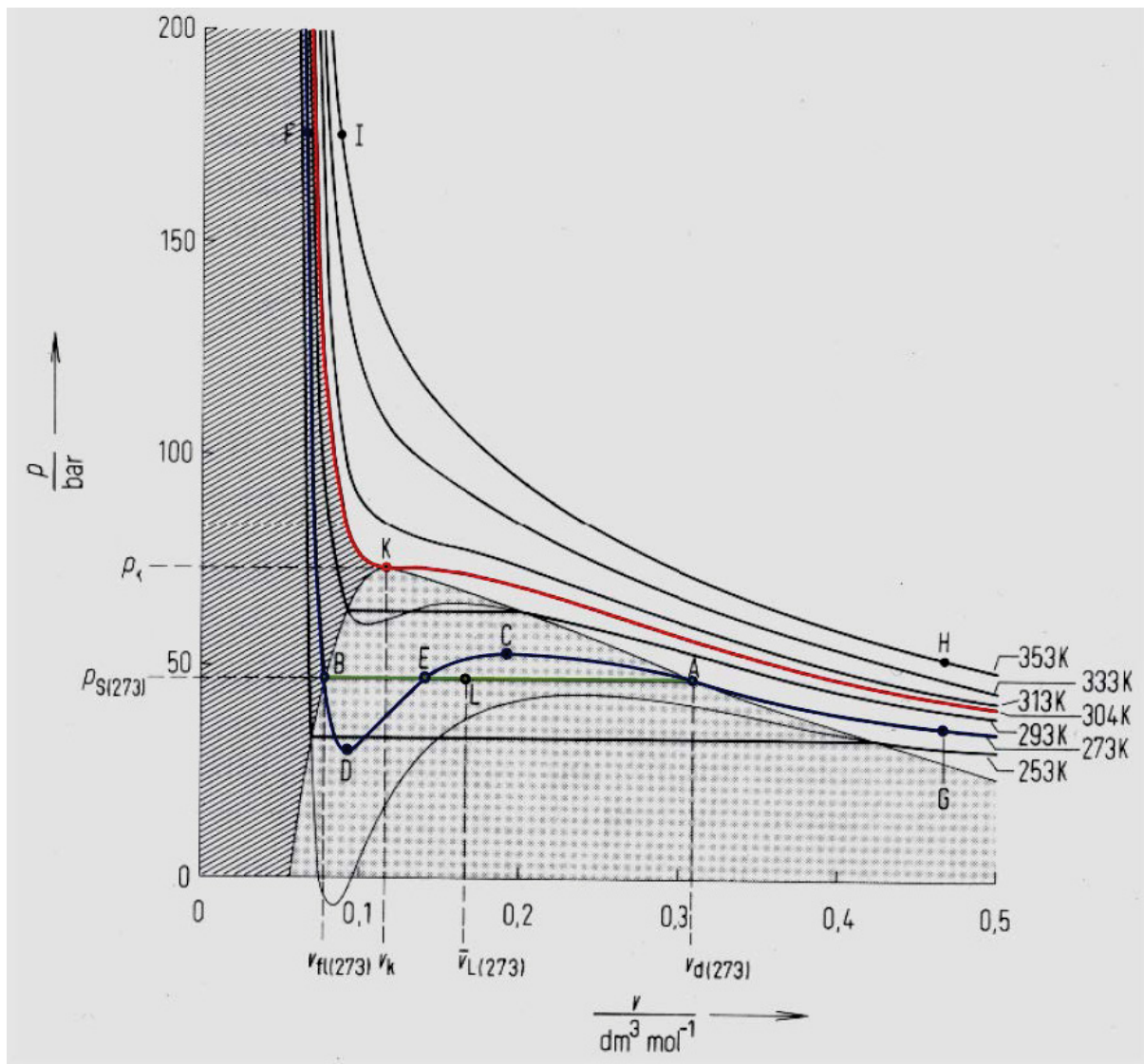

Fig. 2.5.: Isotherms of a real gas above, at and below the critical temperature (from: Gerd Wedler und Hans-Joachim Freund, Lehrbuch der Physikalische Chemie, p. 271, 6.Auflage, Weinheim 2012. Copyright Wiley-VCH Verlag GmbH & Co. KGaA. Reproduced with permission.)

Note that, for isotherms below the critical point, the part from D to C shown in figure 2.5., corresponds to an increase in sample pressure with increasing sample volume, which is physically impossible. The reason for this non-realistic behavior is that the van-der-Waals-Eq. (Eq.2.25) ignores the phenomenon of phase transitions completely. In reality, if we start at point G with a real gas with high volume, low pressure and subcritical temperature, and increase the pressure, the volume will decrease strongly until we reach point A. From there, in our experiment, in contrast to the theoretical prediction of the van-der-Waals-Eq., we will follow the horizontal line. This means the volume will decrease strongly while the pressure keeps constant, which is simply the case due to condensation of our gas at constant pressure.

Once we reach point B, all material has become liquid, and due to the low incompressibility of the condensed phase the pressure now has to increase strongly if we try to further decrease the sample volume. Here, it is important that the experimental horizontal connecting the pure liquid at B with the pure gas at A can be constructed from the van-der-Waals-curve by keeping the area below the two different curves, which corresponds to the overall work, identical. This is obvious since the energy change of the system from point A to point B corresponding to the condensation heat has to be independent of the process itself. At temperatures above the critical temperature, this condensation is not possible any longer, and there is no difference between gas and liquid.

The macroscopic variables of state of the critical point, (p_K, V_K, T_K) , can be expressed as simple functions of the microscopic variables of the Van-der-Waals-Eq. (a, b) and vice versa, if you consider that within the isotherm at $T = T_K$ it is a turning point with slope zero. Therefore, the first and second derivative of $p(V)$ have to be zero, that is,

$$\left(\frac{dp}{dV}\right)_{V_K, T_K} = \left(\frac{d^2p}{dV^2}\right)_{V_K, T_K} = 0 \quad (\text{Eq.2.27})$$

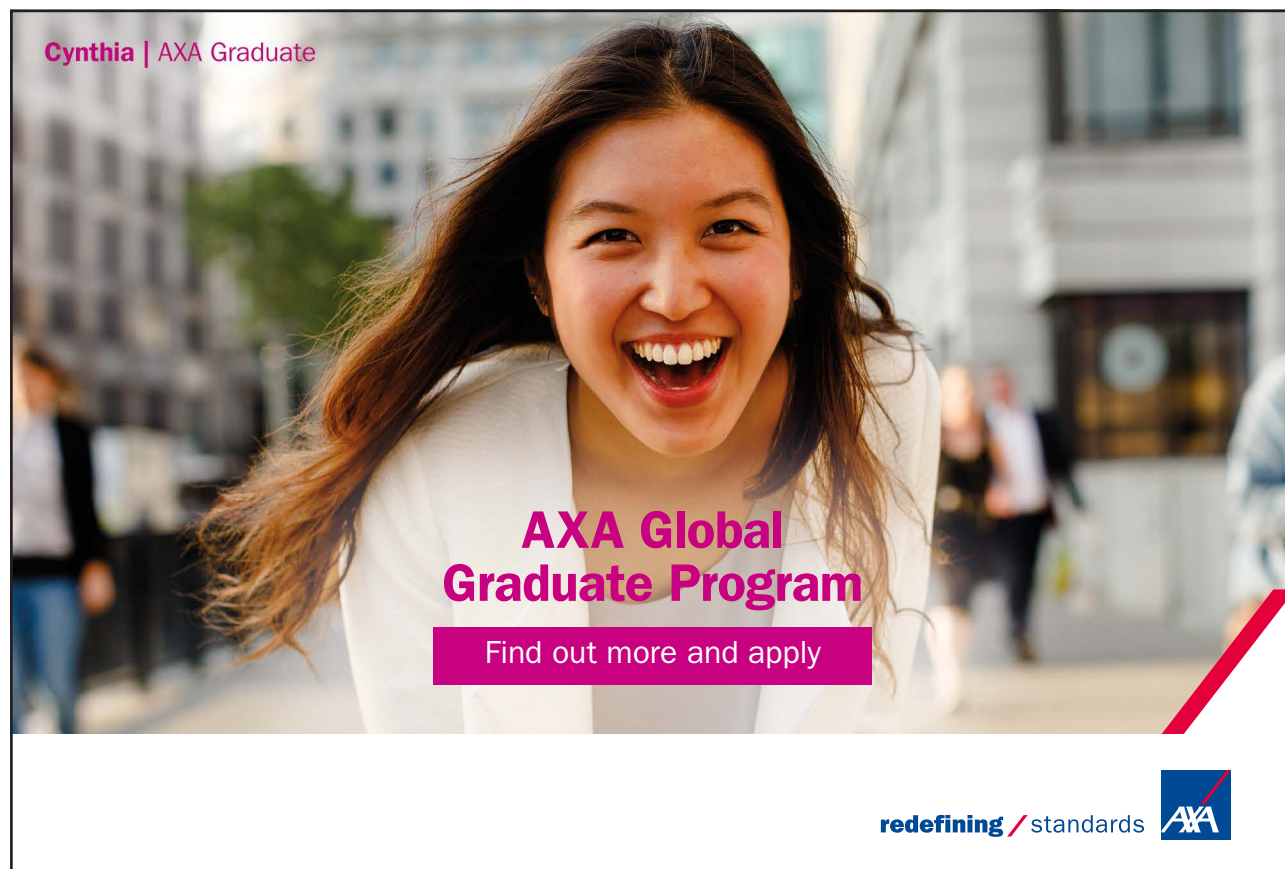

Cynthia | AXA Graduate

AXA Global Graduate Program

Find out more and apply

redefining / standards AXA

Solving the Van-der-Waals-Eq. and using, in addition, these derivatives, one obtains the following relations between the microscopic van-der-Waals-parameters of a real gas and its critical point:

$$b = \frac{1}{3} \cdot V_K \quad (\text{Eq.2.28})$$

$$a = \frac{9}{8} \cdot R \cdot T_K \cdot V_K \quad (\text{Eq.2.29})$$

$$p_K = \frac{3}{8} \cdot R \cdot \frac{T_K}{V_K} = \frac{a}{3 \cdot b^2} \quad (\text{Eq.2.30})$$

In conclusion, it is possible to determine the microscopic characteristics of the real gas, such as effective single particle volume b and interparticle attraction a , via a macroscopic measurement of the pressure in dependence of volume at constant temperature, and consequent identification of the critical point.

Example 2.3:

Compare the volume and pressure of the ideal and real gas at room temperature and normal pressure for the two examples He and CO₂. The respective van-der-Waals parameters are $a = 363.7 \cdot 10^{-3}$, $b = 0.0427 \cdot 10^{-3}$ for CO₂, and $a = 3.45 \cdot 10^{-3}$, $b = 0.0237 \cdot 10^{-3}$ for He (all quantities in SI-units).

Solution: we compare the van-der Waals equation and the ideal gas equation to obtain the following expressions for the real and ideal quantities of state, respectively, using $n = 1$ mole.

$$\left(p_{re} + \frac{a}{V_{re}^2}\right) \cdot (V_{re} - b) = R \cdot T \quad \text{and} \quad p_{id} \cdot V_{id} = R \cdot T,$$

Therefore

$$p_{re} = p_{id} - \frac{a}{V_{re}^2} \quad \text{and} \quad V_{re} = V_{id} + b.$$

Using ideal conditions $T = 293$ K and $p_{id} = 10^5$ Pa, we obtain $V_{id} = \frac{8.314 \cdot 293}{10^5} \text{ m}^3 = 0.02436 \text{ m}^3$. Based on this result and the set of van-der Waals parameters, we get for

$$\text{He:} \quad V_{re} = V_{id} + b = (0.02436 + 0.0237 \cdot 10^{-3}) \text{ m}^3 = 0.02438 \text{ m}^3$$

$$p_{re} = p_{id} - \frac{a}{V_{re}^2} = \left(10^5 - \frac{3.45 \cdot 10^{-3}}{0.02438^2}\right) \text{ Pa} = 99994 \text{ Pa}$$

$$\text{CO}_2: \quad V_{re} = V_{id} + b = (0.02436 + 0.0427 \cdot 10^{-3}) \text{ m}^3 = 0.02440 \text{ m}^3$$

$$p_{re} = p_{id} - \frac{a}{V_{re}^2} = \left(10^5 - \frac{363.7 \cdot 10^{-3}}{0.02440^2}\right) \text{ Pa} = 99389 \text{ Pa}$$

We conclude that the ideal gas equation is quite valid for common gases at room temperature. Even for CO₂ which has considerable van-der-Waals attractive forces due to its dipole character, at room temperature the pressure is only reduced by much less than 1% compared to the ideal gas.

2.3 The fundamental laws of thermodynamics

2.3.1 Definition of temperature

If two systems A and B coexist in thermal equilibrium, and also B is in thermal equilibrium with a 3rd system C, then all three systems are in thermal equilibrium and have the same temperature. This simple principle is the basis for temperature measurements as well as one foundation of phase equilibrium and chemical equilibrium.

2.3.2 The first law of thermodynamics

The first law of thermodynamics is the law of conservation of energy including, in contrast to conventional physics, heat as an additional means of energy exchange between system and environment. It is formulated for differential changes or measurable changes in total energy U , respectively, as:

$$dU = \delta Q + \delta W \quad \dots \quad \Delta U = Q + W \quad (\text{Eq.2.31})$$

with U the internal energy, Q the heat flow, and W the work, i.e. typically volume work (expansion or compression). To define the heat flow, we refer to adiabatic processes, where the system is thermally isolated from its environment, and therefore $\Delta U_{(ad)} = Q + W = W_{(ad)}$, therefore $Q = -W + W_{(ad)}$. Note that heat and work are not quantities of state, in contrast to U , but depend on the process itself, whereas ΔU only depends on the final and the initial state. As a consequence, Q and W also are not total differentials, but have to be formulated as δQ or δW , respectively. In experimental practice, ΔU becomes important for processes at constant volume (isochors), since then it corresponds directly to the heat exchange between system and environment. On the other hand, for isobaric processes the heat transfer corresponds to the enthalpy change ΔH ($H = U + pV$, see Eq.(2.33)):

$$\text{isochors:} \quad \delta W = 0 \quad \rightarrow \quad dU = \delta Q = c_V \cdot dT \quad (\text{Eq.2.32})$$

$$\text{isobars:} \quad \delta W = -pdV = -RdT \quad \rightarrow \quad dH = d(U + pV) = \delta Q = c_p \cdot dT \quad (\text{Eq.2.33})$$

For illustration, let us consider these two processes with a system of 1 mole ideal gas. Note that, at given heat exchange Q , the temperature effect ΔT will be larger in case of the isochoric process, since in case of the isobaric part of the energy will be lost due to volume expansion work. As a consequence, the heat capacity c_V has to be smaller than c_p , namely $c_p - c_V = R$ for 1 Mol ideal gas.

Importantly, for the ideal gas the energy change for isothermal processes is zero, i.e. in general:

$$dU = \delta Q + \delta W = c_V dT = 0 \quad (\text{Eq.2.34})$$

This means that the volume expansion work is compensated by heat exchange, or $\delta Q = -\delta W$!

For 1 mole ideal gas, this work can be calculated as:

$$dW = -pdV = -\frac{RT}{V}dV \rightarrow W = -\int_{V_1}^{V_2} \frac{RT}{V}dV = -RT \cdot \ln\left(\frac{V_2}{V_1}\right) \quad (\text{Eq.2.35})$$

In contrast, for real gases one also has to take into account the internal work versus the attractive interparticle interactions, and the total internal energy change is given as:

$$dU = c_V dT + \pi dV = 0 \quad (\text{Eq.2.36})$$

Therefore, if a real gas is expanding into vacuum, both heat exchange (Q), volume work (W) and, as a consequence of the first law of thermodynamics, the overall change in internal energy (ΔU) are all zero. The temperature will thus drop to compensate for the internal work (πdV). (Joule's experiment).

Finally, let us finish our discussion of the first law of thermodynamics in the context of ideal gas processes with the adiabatic process. Here, the first law will allow us a very simple derivation of an equation of state for adiabatic processes, which will come in handy in the next section about the 2nd law of thermodynamics. For adiabatic processes of 1 Mol ideal gas the first law reads as following:

$$dU = \delta Q + \delta W = 0 - pdV = c_V dT = \delta W_{ad} \quad (\text{Eq.2.37})$$

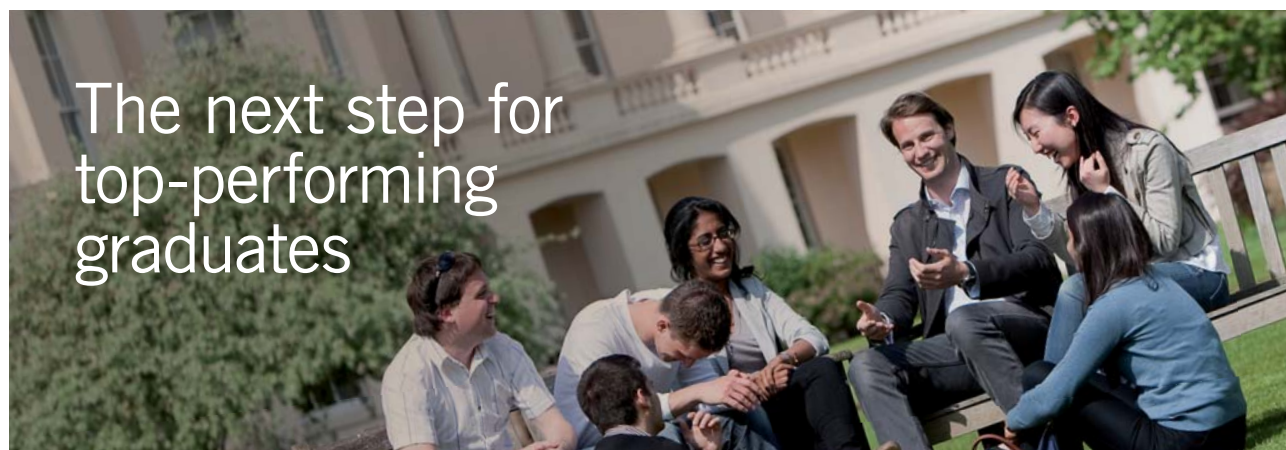

Masters in Management



Designed for high-achieving graduates across all disciplines, London Business School's Masters in Management provides specific and tangible foundations for a successful career in business.

This 12-month, full-time programme is a business qualification with impact. In 2010, our MiM employment rate was 95% within 3 months of graduation*; the majority of graduates choosing to work in consulting or financial services.

As well as a renowned qualification from a world-class business school, you also gain access to the School's network of more than 34,000 global alumni – a community that offers support and opportunities throughout your career.

For more information visit www.london.edu/mm, email mim@london.edu or give us a call on +44 (0)20 7000 7573.

* Figures taken from London Business School's Masters in Management 2010 employment report



To derive our equation of state, we insert the ideal gas law for p , and obtain:

$$-\frac{RT}{V} dV = c_V dT \quad (\text{Eq.2.38})$$

$$-\frac{dV}{V} = \frac{c_V}{R} dT \quad (\text{Eq.2.39})$$

Integration of this differential with finite boundaries (T_1, V_1) as initial and (T_2, V_2) as final state yields

$$-\ln\left(\frac{V_2}{V_1}\right) = \frac{c_V}{R} \ln\left(\frac{T_2}{T_1}\right) \quad (\text{Eq.2.40})$$

Or

$$V_1 \cdot T_1^{c_V/R} = V_2 \cdot T_2^{c_V/R} = \text{const} \quad (\text{Eq.2.41})$$

If you apply the ideal gas law to replace T with p , and consider that for one mole ideal gas $c_p - c_V = R$ then,

$$p \cdot V^{c_p/c_V} = \text{const} \quad (\text{Eq.2.42})$$

This is our equation of state for an adiabatic process, expansion or compression, of the ideal gas, allowing us to calculate any missing variable of state.

Comparing this equation with the equation of state for the isotherm of an ideal gas (Boyle's law: $p \cdot V = \text{const}$), we expect at identical volume expansion from identical initial states that the adiabatic $p(V)$ drops more in pressure than the isotherm, i.e. that also the temperature is lowered, since in this case the expansion volume work is not compensated by heat exchange.

2.3.3 The 2nd law of thermodynamics and the Carnot process

Whereas the first law deals with the energy, the 2nd law of thermodynamics is concerned with a new quantity of state, the entropy. We should note that in thermodynamics "order" is not just spatial order in the usual 3-dim space. It rather refers to a "phase space" which includes momentum (velocity) coordinates. For example, in an ideal gas, the spatial ordering of molecules is independent of temperature at constant volume. However, the "order" in velocity space *decreases* with increasing temperature (and increasing average molecular velocity in a gas) resulting in an increase of entropy. Quantitatively and macroscopically, entropy is defined as the reversibly exchanged amount of heat between system and environment at given temperature T

$$dS = \frac{dQ_{rev}}{T} \rightarrow \Delta S = \frac{Q_{rev}}{T} \quad (dT = 0) \quad (\text{Eq.2.43})$$

This means that $dU = TdS - dW_{rev}$, and we will show later that the reversible work is the maximum you can get, as a theoretical limit. Eq.2.43 is the first part of the 2nd law of thermodynamics, defining the change in entropy as a new fundamental quantity valid for strictly reversible processes.

To discuss the maximum work one can extract from a reversible cyclic process, we next consider the famous Carnot process as a reference. This process describes an ideal reversible and therefore hypothetical machine partially transferring heat into work. The principle is illustrated in figure 2.7.

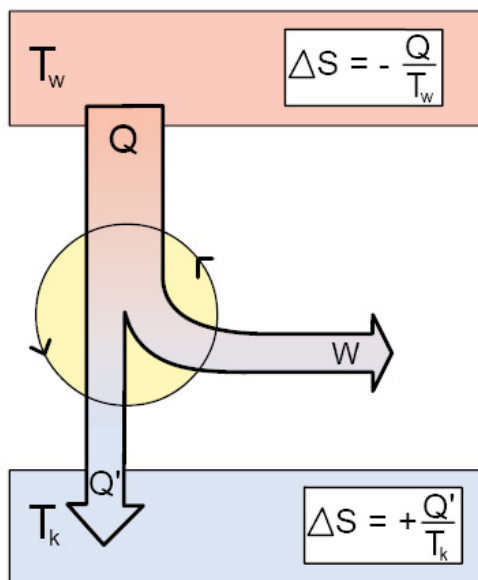

Fig. 2.7.: thermodynamic machines – principle of the Carnot process

This machine is based on the reversible heat flow from a reservoir with higher temperature T_w to a reservoir with colder temperature T_k . Note that both reservoirs are considered to be infinitely large, so their temperature will not change during the process. Importantly, the amount of heat transferred to the colder reservoir Q' is smaller than the amount of heating taken from the hot one Q , and the difference $W = Q - Q'$ can be used as a volume expansion work. Note that the overall entropy change for this reversible process is zero, i.e.

$$\Delta S_{tot} = -\frac{Q}{T_w} + \frac{Q'}{T_k} = 0 \quad (\text{Eq.2.44})$$

If we are running our machine in reverse direction, which should not change the respective amounts of heat and work, since the process is perfectly reversible, we obtain a so-called heat pump, which transfers heat from cold to warm upon work input, in the reverse direction compared to the spontaneous heat flow.

The efficiency of this type of machine transferring heat into work is defined as the ratio of work output over heat input, i.e.

$$\eta = \frac{W}{Q} = \frac{T_w - T_k}{T_w} < 1 \quad (\text{Eq.2.45})$$

Only if $T_k = 0$, a limit which according to the 3rd law of thermodynamics (see section 2.3.5.) can never be reached in practice, the efficiency of our machine may reach one. In general, one cannot transfer heat Q into work W without loss, and the highest efficiency possible is given by the reversible machine, a limit which can never be reached in practice. Note that, in accordance with energy conservation, it could be possible to transfer heat into work directly. However, the 2nd law tells us that this cannot be achieved: meaning that heat somehow is a worse form of energy compared to work from a practical point of view. This is directly related to entropy, as we will see. First, let us derive the above formula describing our limit in heat-work conversion efficiency by discussion of the Carnot process in more detail. This hypothetical ideal circular process is based on isothermal and adiabatic expansions and compressions, as shown in figure 2.8.

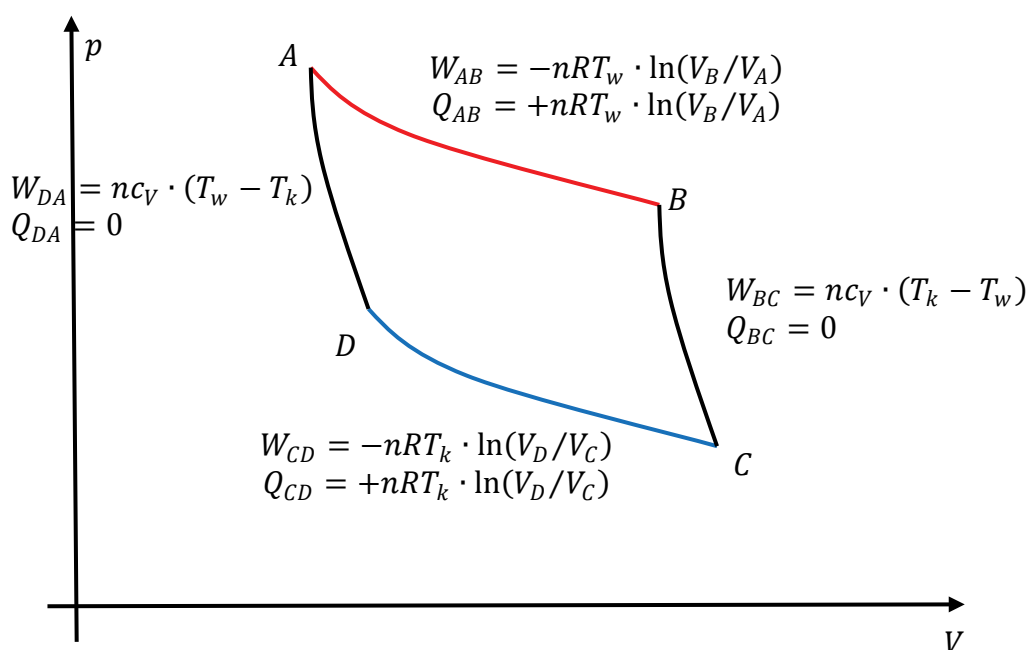

Fig. 2.8: p-V-circle of the Carnot process

The first step is an isothermal expansion from A to B at the higher temperature T_w , i.e. the ideal gas here remains in thermal equilibrium with the hotter reservoir. During this first step, the gas takes up the heat amount $Q = Q_{AB}$ from the hot reservoir to compensate the volume work. Next, the gas expands to C adiabatically in thermal isolation, and therefore its temperature has to drop to T_k . The third step is an isothermal compression to D, this time in contact (or thermal equilibrium) with the colder reservoir. To compensate for the compression work, here the heat amount $Q' = Q_{CD}$ is transferred from the gas to the reservoir. Finally, the circle is closed from D to A with an adiabatic compression, where the temperature of the gas increases again to T_w . The amount of work and heat exchanged between gas and environment during each step are shown in the figure.

The amount of total work per cycle is given as

$$|W| = \sum |W_i| = \left| -RT_w \cdot \ln\left(\frac{V_B}{V_A}\right) + c_V \cdot (T_k - T_w) - RT_k \cdot \ln\left(\frac{V_D}{V_C}\right) + c_V \cdot (T_w - T_k) \right| \quad (\text{Eq.2.46})$$

or

$$|W| = \left| -RT_w \cdot \ln\left(\frac{V_B}{V_A}\right) - RT_k \cdot \ln\left(\frac{V_D}{V_C}\right) \right| \quad (\text{Eq.2.47})$$

Whereas the amount of heat needed to obtain this work, exchanged by the first step, is given as:

$$|Q| = \left| RT_w \cdot \ln\left(\frac{V_B}{V_A}\right) \right| \quad (\text{Eq.2.48})$$

Because the two adiabatic curves in figure 2.8. connect different states with identical temperature, respectively, the volume ratio has to be identical as well, i.e.

$$\frac{V_A}{V_D} = \frac{V_B}{V_C} \leftrightarrow \frac{V_C}{V_D} = \frac{V_B}{V_A} \quad (\text{Eq.2.49})$$

If we insert this equation into Eq.2.46, we obtain for the efficiency of the Carnot machine:

$$\eta = \frac{|\sum W_i|}{|Q|} = \frac{RT_w \cdot \ln\left(\frac{V_B}{V_A}\right) - RT_k \cdot \ln\left(\frac{V_B}{V_A}\right)}{RT_w \cdot \ln\left(\frac{V_B}{V_A}\right)} = \frac{T_w - T_k}{T_w} < 1 \quad (\text{Eq.2.50})$$



Get Internationally Connected at the University of Surrey

MA Intercultural Communication with International Business
MA Communication and International Marketing



MA Intercultural Communication with International Business

Provides you with a critical understanding of communication in contemporary socio-cultural contexts by combining linguistic, cultural/media studies and international business and will prepare you for a wide range of careers.

MA Communication and International Marketing

Equips you with a detailed understanding of communication in contemporary international marketing contexts to enable you to address the market needs of the international business environment.

For further information contact:

T: +44 (0)1483 681681

E: pg-enquiries@surrey.ac.uk

www.surrey.ac.uk/downloads



Click on the ad to read more

Work and heat exchanged during one working cycle between the ideal gas and the environment can simply be expressed as definite integrals or areas in a $p(V)$ or $T(S)$ representation, respectively.

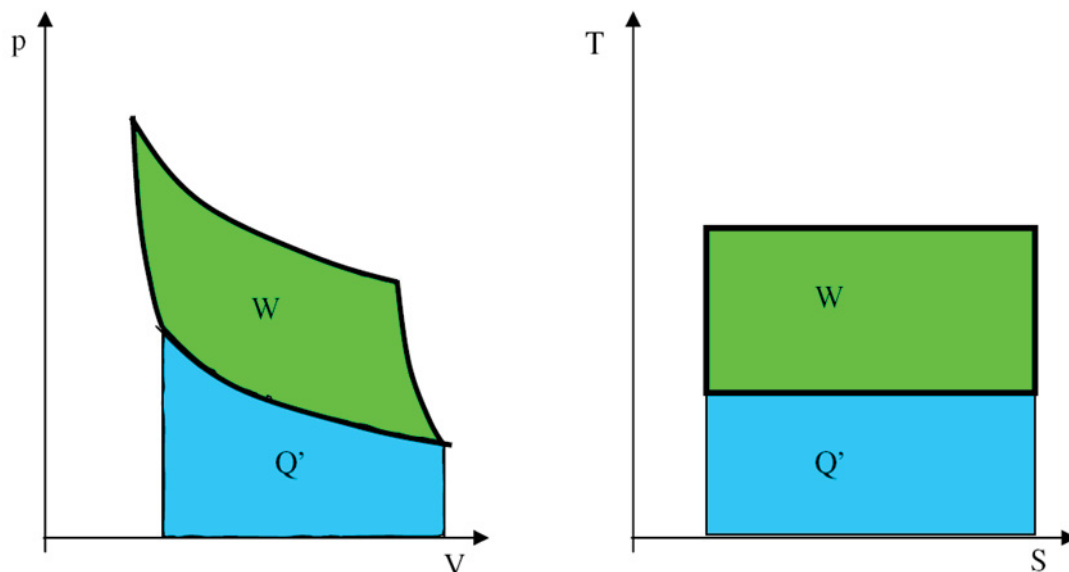

Fig. 2.9.: p-V- and T-S-diagram of the Carnot process, areas indicating the amount of transferred energy

Another reversible cyclic process with efficiency identical to that of the Carnot process is the Stirling process, which corresponds to a Carnot cycle with the two adiabatics replaced by two isochors, respectively.

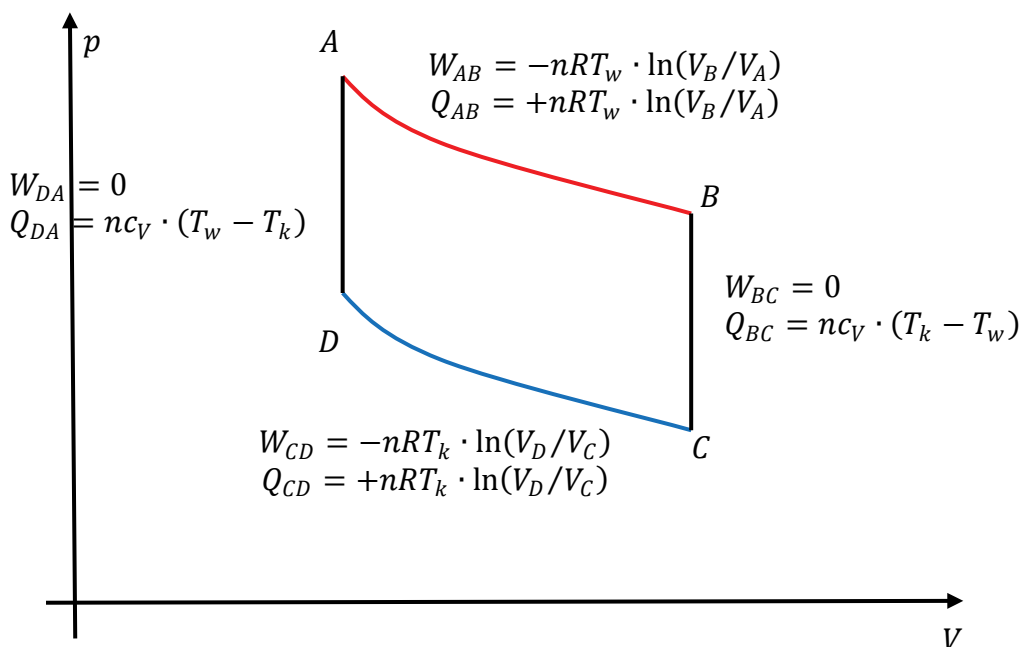

Fig. 2.10: p-V- circle of the Stirling process

Finally, the 2nd part of the 2nd law of thermodynamics is related to irreversible spontaneous processes. Note that it is not possible to prove the following statements, but, according to common experience, the following formulations of the 2nd law of thermodynamics in practice are always fulfilled.

- i. For any irreversible spontaneous process the overall entropy (system + environment) has to increase, i.e. $\Delta S > 0$. The general definition of the change in entropy at given temperature has been given by Clausius as $\Delta S \geq \frac{Q}{T}$, with $\Delta S = \frac{Q}{T}$ for reversible processes, and $\Delta S > \frac{Q}{T}$ for irreversible processes, respectively. For system plus environment, the overall heat transfer $Q = 0$, therefore in case of irreversible processes $\Delta S > 0$.
- ii. Heat always flows, spontaneously, from warm to cold.
- iii. An irreversible process is always less efficient than a reversible one, meaning that heat is converted into work with a lower degree of efficiency. Let us consider a reversible machine transferring heat into work (= generator), with an efficiency of:

$$\eta = \frac{W}{Q} = \frac{T_w - T_k}{T_w} < 1 \quad (\text{Eq.2.51})$$

Running the machine in reverse mode, i.e. transferring work into heat flow, we have built a so-called heat pump with power conversion defined as:

$$\varepsilon = \eta^{-1} = \frac{Q}{W} = \frac{T_w}{T_w - T_k} > 1 \quad (\text{Eq.2.52})$$

If we now compare two given machines or two given heat pumps working with identical temperature reservoirs, one reversible and the other irreversible, according to the 2nd law of thermodynamics

$$\eta_{rev} > \eta_{irrev} \quad \text{and} \quad \varepsilon_{rev} > \varepsilon_{irrev}$$

Only for the reversible machine it is not important if it runs as a generator or as heat pump, in respect to the respective amounts of transferred energy. On the other hand, if we reverse the processes of our irreversible machine, not only the directions but also the amount of the transferred energies will change, and therefore $\varepsilon_{irrev} \neq \eta_{irrev}^{-1}$.

Note that these different expressions for the 2nd law of thermodynamics related to spontaneous irreversible processes are all equivalent, as can be shown simply if one considers a coupled machine consisting of a generator and a heat pump both working between the same heat reservoirs, where the work generated by machine I is used completely to run the heat pump (machine II). First, let us prove via this coupled machine, in combination with the 2nd law of thermodynamics, that all reversible machines must have identical efficiency and power conversion.

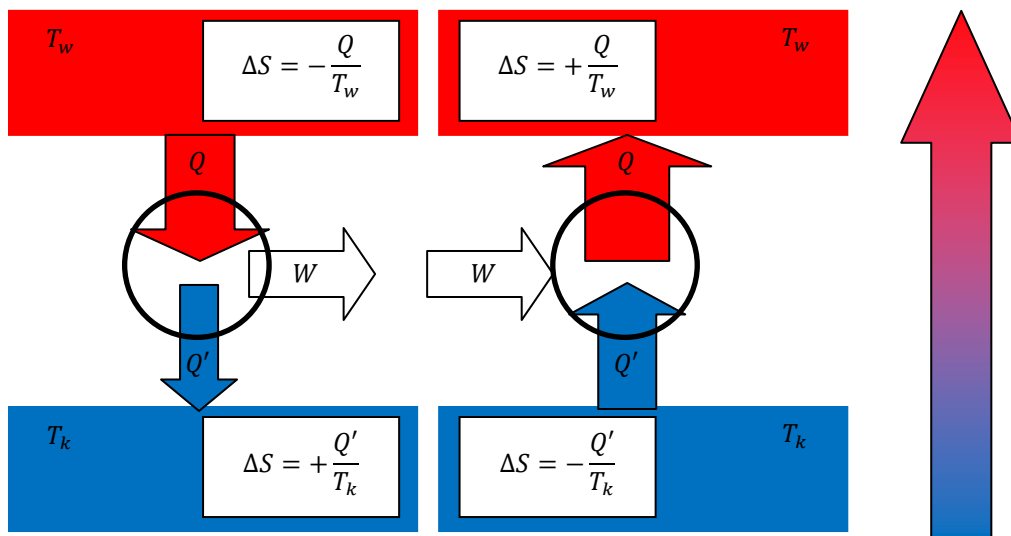

Fig. 2.11: Coupling of reversible generator and reversible heat pump, assuming different efficiencies

We first assume that there exist two reversible machines with different efficiencies, and choose the generator as the machine with the higher efficiency, while the reversible machine with lower efficiency is running in reverse mode as heat pump. In conclusion, we get

$$\eta_{II} = \frac{|W|}{|Q_{II}|} < \eta_I = \frac{|W|}{|Q_I|} \tag{Eq.2.53}$$



or $|Q_I| < |Q_{II}|$ and $|Q_I'| < |Q_{II}'|$ (Eq.2.54)

This corresponds to a spontaneous flow of heat from the cold to the hot reservoir, which is physically not possible, or at least has never been observed.

Next, let us consider the coupling of a reversible and an irreversible machine. There are two possibilities: either machine I is reversible and the heat pump II is irreversible, or the heat pump II is the reversible machine and the generator I the irreversible one. Let us consider the first case:

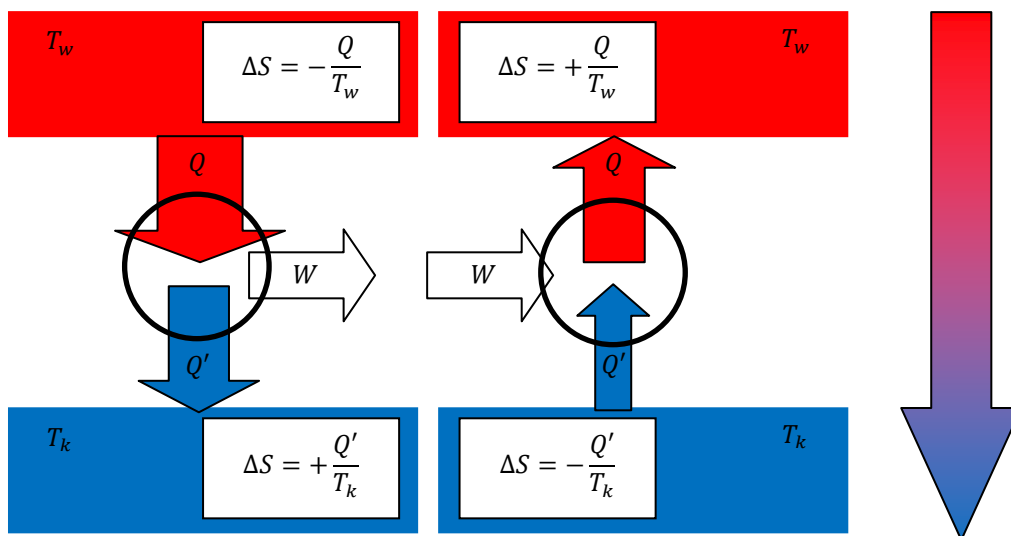

Fig. 2.12: Coupling of two processes, one reversible the other irreversible, always leading to spontaneous heat exchange, i.e. heat flowing from the hot to the cold reservoir.

The reversible machine one, if running in reverse mode, should have a higher power conversion than machine II. Note here again that only for the reversible machine it does not matter, in terms of amount of heat and work exchange, in which mode the machine is running. If you reverse the mode of an irreversible machine, as stated by the name, these amounts of energy transfer will change. For our coupled machine we now get the following net effect:

$$\epsilon_I = \frac{|Q_I|}{|W|} > \epsilon_{II} = \frac{|Q_{II}|}{|W|}, \text{ or } |Q_I| > |Q_{II}| \text{ and } |Q_I'| > |Q_{II}'|. \quad (\text{Eq.2.55})$$

This corresponds to a spontaneous irreversible heat flow from the hot reservoir to the cold one. Also, it should be noted that the change in entropy from the point of view of the two infinitely large reservoirs is given by the expression in the figure, whereas from point of view of the irreversible machine $\Delta S > Q/T$. As a consequence, the overall change in entropy for our coupled machine $\Delta S > Q_{II}'/T_k - Q_{II}/T_k = 0$, or $\Delta S > 0$, which is another synonym for irreversibility.

Finally, if we couple an irreversible generator I with a reversible heat pump II,

$$\eta_{II} = \frac{|W|}{|Q_{II}|} > \eta_I = \frac{|W|}{|Q_I|} \quad (\text{Eq.2.56})$$

$$\text{or } |Q_I| > |Q_{II}| \text{ and } |Q_I'| > |Q_{II}'|. \quad (\text{Eq.2.57})$$

Again, the introduction of one irreversible process causes the spontaneous irreversible flow of heat from hot to cold and an increase in overall entropy.

Example 2.4.:

Calculate the minimum energy necessary to cool 1 L of water within a fridge (from $T = RT$ (room temperature, 21°C) to $T = 4^\circ\text{C}$). Assume that the heat capacity of water is constant in this temperature regime ($= 4.18 \text{ J}/(\text{g K})$), and use the Carnot-process as the best case reference.

Solution: The amount of heat which will be transferred from the warm water to the surroundings (here: the fridge) without additional cooling is given as

$$Q = c_p \cdot \Delta T = 4.18 \cdot 1000 \cdot 17 \text{ J} = 71060 \text{ J}$$

To maintain the temperature in the fridge, this amount of heat has to be compensated following the working scheme of the heat pump, i.e. transferring 71060 J plus electrical work into a larger amount of excess heat which is transferred from the fridge into the kitchen. In the best case, the efficiency of the transfer of electrical energy (= work) to heat is given as

$$\varepsilon = \frac{Q}{W} = \frac{T_w}{T_w - T_k} = \frac{294}{17} = 17.29$$

In addition, energy conservation states that the amount of work plus compensated cooling heat (= 71060 J, see above) has to equal the amount of heat transferred from the fridge to the kitchen (Q), therefore

$$\varepsilon = 17.29 = \frac{Q}{W} = \frac{Q' + W}{W} = \frac{71060 \text{ J} + W}{W} \Rightarrow (17.29 - 1) \cdot W = 71060 \text{ J} \Rightarrow W = 4362 \text{ J}$$

To cool 1 L of water from room temperature to the 4°C within our fridge, we therefore at least need the following amount of electric energy:

$$4362 \text{ J} = 4362 \text{ W} \cdot \text{s} = 1.212 \cdot 10^{-3} \text{ kWh.}$$

2.3.4 The free energy and the free enthalpy:

From the 2nd law of thermodynamics and the meaning of reversibility, we realize that, to judge the efficiency of a given chemical process, we have to introduce two more quantities of state which combine energetic and entropic aspects, the free energy A (or Helmholtz energy) and the free enthalpy G (Gibbs enthalpy). The total differential of these new quantities is given as:

$$dA = d(U - TS) = TdS - pdV - TdS - SdT = -SdT - pdV \quad (\text{Eq.2.58})$$

$$dG = d(H - TS) = TdS + Vdp - TdS - SdT = -SdT + Vdp \quad (\text{Eq.2.59})$$

Note that these formulae have been derived by using the following expression for the 1st law of thermodynamics: $dU = TdS - pdV = dQ_{rev} - pdV = dQ_{rev} - dW_{rev}$. Therefore, one can show that $\Delta A = \Delta U - T\Delta S$ is the maximum work which you can get from a given isotherm process, which is the case if the process is reversible. Let us illustrate this with two quantitative examples:

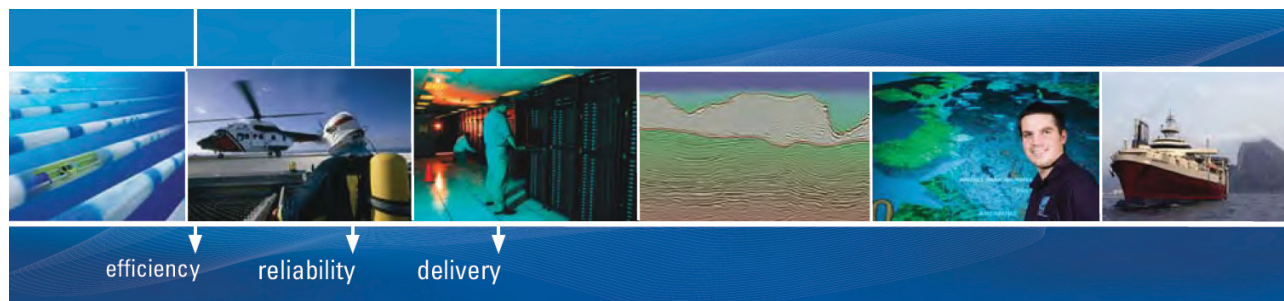

As a leading technology company in the field of geophysical science, PGS can offer exciting opportunities in offshore seismic exploration.

We are looking for new BSc, MSc and PhD graduates with Geoscience, engineering and other numerate backgrounds to join us.

To learn more our career opportunities, please visit www.pgs.com/careers

A Clearer Image
www.pgs.com



- i. We consider an energetically favored, but entropically unfavorable, chemical process, where both the energy and entropy of our system (subscript S) are decreasing (for example crystallization of the solute out of a saturated solution), and calculate the exchange in heat and work with the environment (subscript U) for the reversible and the irreversible case:

$$\Delta U_S = -1000 \text{ J}, \quad \Delta S_S = -10 \text{ J/K}, \quad T = 50 \text{ K}, \quad \text{therefore}$$

reversible: $Q_{rev} = T\Delta S_S = -500 \text{ J}, \quad W_{rev} = \Delta A = \Delta U_S - Q = -500 \text{ J}$

irreversible: $Q_{irrev} < T\Delta S_S = -600 \text{ J}, \quad W_{irrev} = \Delta A = \Delta U_S - Q = -400 \text{ J}.$

This means that in case of an irreversible process, the work you can get is always smaller than from the reversible process.

- ii. Next, let us consider a process which is both energetically and entropically favored (for example burning of fuel).

$$\Delta U_S = -1000 \text{ J}, \quad \Delta S_S = 10 \text{ J/K}, \quad T = 50 \text{ K}, \quad \text{therefore}$$

reversible: $Q_{rev} = T\Delta S_S = 500 \text{ J}, \quad W_{rev} = \Delta A = \Delta U_S - Q = -1500 \text{ J}$

irreversible: $Q_{irrev} < T\Delta S_S = 400 \text{ J}, \quad W_{irrev} = \Delta A = \Delta U_S - Q = -1400 \text{ J}.$

Again, the work you can get from the process is largest for the reversible case. Note here that in our example the work output is much larger than the energy change of the system!

The change in Gibbs free enthalpy has a similar meaning: it describes the maximum work you can get from a process at isothermal and isobaric conditions, any work due to volume change of the system excluded. This is derived as following:

$$dG_T = dH - TdS = dU + d(pV) - TdS = dW_{rev} + pdV + Vdp \quad (\text{Eq.2.60})$$

$$dG_{T,p} = dW_{rev} + pdV = (dW_{rev}' - pdV) + pdV = dW_{rev}' \quad (\text{Eq.2.61})$$

with dW_{rev}' the reversible or maximum work one can get with the exclusion of any volume work $-pdV$. For example, this meaning of ΔG is obvious if you consider electrochemical processes (see section 4):

$$\Delta G = -z \cdot F \cdot EMK \quad (\text{Eq.2.62})$$

where EMK is the maximum voltage you can get if your chemical battery is running reversible, and $-z \cdot F \cdot EMK$ is the maximum output in electric energy or work.

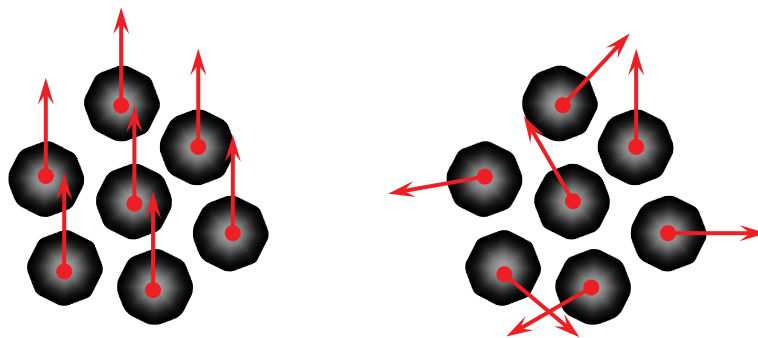

Fig. 2.13: difference of work (left) and heat (right), and the 2nd law of thermodynamics. Note that, if the gas is expanding in one direction (= volume work), during this process a regular flow of the particles in this direction is needed. In contrast, if the gas is heated at constant volume, only the velocity of the irregular motion of the gas particles is increasing.

Obviously, the 2nd law of thermodynamics and all its consequences are based on a fundamental difference between the two ways of energy transfer, work and heat. As shown in figure 2.13, work usually requires some regular motion of all molecules of the system, whereas heat is just based on the average velocity of the particles which are moving irregularly. As a consequence, heat has a “lower quality” and cannot be transferred into the much more regular work by 100%.

STUDY.
The stuff you'll need to make a good living

PLAY.
The stuff that makes life worth living

NORWAY.
YOUR IDEAL STUDY DESTINATION.

WWW.STUDYINNORWAY.NO
FACEBOOK.COM/STUDYINNORWAY

Click on the ad to read more

Summary of thermodynamic quantities of state and their practical meaning:

(i) internal energy:

The change in internal energy of a process is corresponding to the heat exchange with the environment at isochor conditions:

$$\Delta U_V = c_V \cdot \Delta T,$$

with c_V the respective heat capacity.

(ii) enthalpy:

The change in enthalpy of a process is corresponding to the heat exchange with the environment at isobar conditions:

$$\Delta H_p = c_p \cdot \Delta T,$$

with c_p the respective heat capacity. Note that for gases (1 mol particles), $c_p - c_V = R$.

(iii) entropy:

The change in entropy corresponds to the reversibly exchanges heat divided by the temperature, if the process is run isotherm. More general,

$$\Delta S = \int \frac{dQ_{rev}}{T} dT$$

Note that, in practice, all processes are irreversible. Therefore ΔS is only a limit which can never be measured directly, but be determined by interpolation under different experimental conditions approaching more and more the ideal reversible case (for example, chemical batteries running at very low electrolyte concentrations).

(iv) free energy:

The change in free energy is the maximum work output one can get from a process at isotherm conditions:

$$\Delta A_T = W_{rev}$$

Again, this is a limit which can never be measured directly but only be determined by interpolation of a series of experimental data.

(v) Free enthalpy:

This is the maximum work output one can get from a process at isotherm and isobar conditions, any volume change effect excluded. For example, this could be electrochemical work:

$$\Delta G_{T,p} = W_{rev}' = -z \cdot F \cdot EMK$$

2.3.5 The 3rd law of thermodynamics

Whereas the 1st and 2nd law deal with the change of quantities of state, i.e. internal energy and entropy the 3rd law provides the basis to determine one absolute value: it states that the entropy of a perfect single crystal at $T = 0$ K equals zero, based on the fact that there is only one set of microscopic variables to describe this perfectly ordered system.

2.4 Heat capacities

2.4.1 Heat capacities of gases

We have seen in the last section that, if we try to determine changes in energy or enthalpy from experimentally detected changes in temperature, the respective heat capacities are needed. In experimental practice, these are typically determined by calibration. For pure systems, however, it is possible to predict the heat capacities based on physical models of the microscopic effect of increasing heat on the single particle motion.

For ideal gases, we already mentioned that the difference between isochor and isobar heat capacities in case of 1 Mol particles is simply the gas constant R , which is easily derived as following:

$$Q_p = \Delta H_p = \Delta U_p + p\Delta V = c_V \cdot \Delta T_p + R \cdot \Delta T_p = (c_V + R) \cdot \Delta T_p = c_p \cdot \Delta T_p \quad (\text{Eq.2.63})$$

or

$$(c_V + R) = c_p. \quad (\text{Eq.2.64})$$

To get an estimate for C_v , we consider that a gas molecule consisting of N atoms is described by $3N$ Cartesian coordinates x , y and z , which gives, for the microscopic motion of a molecule, $3N$ different degrees of freedom. 3 always are translation of the whole molecule in x , y and z direction, 3 more are rotation for non-linear molecules, whereas linear molecules only have 2 rotational degrees of freedom because there is no momentum of inertia if this type of molecule is rotating around its molecular main axis.

The remaining $3N - 6$ or $3N - 5$ degrees of freedom, respectively, are attributed to molecular vibrations. Importantly, each degree of freedom of translation or rotation contributes with $R/2$ to the molar heat capacity, while a vibrational degree of freedom contributes with R . This difference can be explained, in a simplified way, by the different types of energy: translation and rotation are purely kinetic energy, whereas vibration contains both kinetic and potential energy, since it describes the motion of atoms in a force field. As an illustrative example, let us consider the two 3-atomic molecules CO_2 and H_2O .

		CO_2 :	H_2O :
Degrees of freedom:	Translation:	3	3
	Rotation:	2	3
	Vibration:	$9 - 5 = 4$	$9 - 6 = 3$

Therefore, the total molar heat capacity of each species is given as:

$$c_{V,\text{CO}_2} = 3 \cdot \frac{R}{2} + 2 \cdot \frac{R}{2} + 4 \cdot R = 6.5 \cdot R \quad (\text{Eq.2.65})$$

$$c_{V,\text{H}_2\text{O}} = 3 \cdot \frac{R}{2} + 3 \cdot \frac{R}{2} + 3 \cdot R = 6 \cdot R \quad (\text{Eq.2.66})$$

The heat capacities differ by nearly 10% just because one rotational degree of freedom is transferred to a vibrational one, if you go from H_2O to CO_2 .

Importantly, these heat capacities are limiting values reached at high sample temperature. To address the vibrational degrees of freedom, you need a certain sample temperature already, typically several 100–1000 K. Rotation is more easily addressed already at room temperature, whereas translational motion is for free, i.e. the 3 translational degrees of freedom are excited already at the evaporation temperature irrespective of its value. As a consequence, the heat capacity of the gas increases stepwise with temperature, and the position of the steps or characteristic excitation temperatures depend on specific molecular parameters such as mass of atoms, bond lengths and bond strengths.

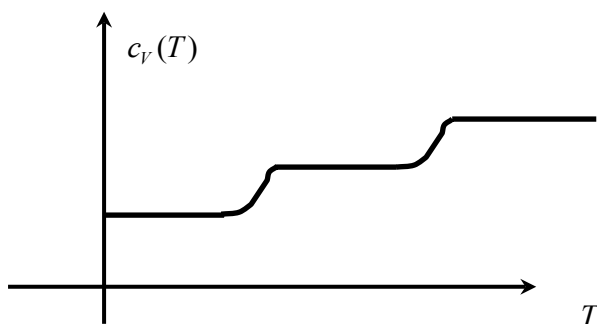

Fig. 2.14: T-dependence of the heat capacity of gaseous molecules

2.4.2 Heat capacities of solids

The atoms within a solid cannot move nor rotate but only undergo vibrational motion. We therefore expect a limiting heat capacity of $3R$ (law of Dulong-Petit), since for a solid consisting of N atoms all $3N$ degrees of freedom correspond to vibrations, and therefore contribute with R per Mole to the heat capacity.

$$c_{V,molar}(T \rightarrow \infty) = 3R \quad (\text{Eq.2.67})$$

However, we have learned in the last section that vibrational modes are not accessible at very low temperature. Therefore, experimentally the heat capacity of solids is given by the following expression (Debye):

$$c_{V,molar}(T) \sim \left(\frac{T}{\theta_D}\right)^3 \quad (\text{Eq.2.68})$$

with θ_D the so-called Debye-temperature that is characteristic for a given solid material.

The thermal accessibility of the vibrations of a solid has theoretically first been addressed by Einstein, who assumed that all atoms have the same oscillatory frequency. According to the Boltzmann factor (see above, section 2.2.2) one then would expect a molar internal energy given as

$$U = 3N_L \cdot h \cdot \nu_E \cdot \left[\frac{\exp\left(-\frac{h \cdot \nu_E}{k \cdot T}\right)}{1 - \exp\left(-\frac{h \cdot \nu_E}{k \cdot T}\right)} \right] \quad (\text{Eq.2.69})$$

And correspondingly the heat capacity is the temperature-derivative, i.e.

$$c_{V,molar} = \left(\frac{dU}{dT} \right) = 3R \cdot \left(\frac{h \cdot \nu_E}{k \cdot T} \right)^2 \cdot \left[\frac{\exp\left(-\frac{h \cdot \nu_E}{k \cdot T}\right)}{\left[1 - \exp\left(-\frac{h \cdot \nu_E}{k \cdot T}\right)\right]^2} \right] \quad (\text{Eq.2.70})$$

At very high temperature, this complicated expression yields (Taylor-series-expansion of the exponential!)

$$c_{V,molar} (T \rightarrow \infty) = 3R \cdot \left(\frac{h \cdot \nu_E}{k \cdot T} \right)^2 \cdot \left[\frac{1 - \frac{h \cdot \nu_E}{k \cdot T}}{\left[1 - 1 + \frac{h \cdot \nu_E}{k \cdot T}\right]^2} \right] \approx 3R \quad (\text{Eq.2.71})$$

According to Eq.2.71, the Einstein model fulfills the Dulong-Petit-law valid for every solid consisting of 1 Mole atoms at very high sample temperature. However, at low temperature the molar heat capacity predicted by Einstein is smaller than the one experimentally found.



Technical training on *WHAT* you need, *WHEN* you need it

At IDC Technologies we can tailor our technical and engineering training workshops to suit your needs. We have extensive experience in training technical and engineering staff and have trained people in organisations such as General Motors, Shell, Siemens, BHP and Honeywell to name a few.

Our onsite training is cost effective, convenient and completely customisable to the technical and engineering areas you want covered. Our workshops are all comprehensive hands-on learning experiences with ample time given to practical sessions and demonstrations. We communicate well to ensure that workshop content and timing match the knowledge, skills, and abilities of the participants.

We run onsite training all year round and hold the workshops on your premises or a venue of your choice for your convenience.

For a no obligation proposal, contact us today at training@idc-online.com or visit our website for more information: www.idc-online.com/onsite/

- OIL & GAS ENGINEERING**
- ELECTRONICS**
- AUTOMATION & PROCESS CONTROL**
- MECHANICAL ENGINEERING**
- INDUSTRIAL DATA COMMS**
- ELECTRICAL POWER**

Phone: +61 8 9321 1702
 Email: training@idc-online.com
 Website: www.idc-online.com



The model by Debye describes the experimental result. In contrast to Einstein, he assumes that the vibrations within a solid cover a whole spectrum of different oscillatory frequencies, starting from zero to ν_E , with the probability (or better: degrees of freedom) of a given frequency as:

$$P(\nu) = 9N \cdot \frac{\nu^2}{\nu_E^3} \quad (\text{Eq.2.72})$$

Note that the total number of degrees of freedom, given as the integral of $P(\nu)$, equals $3N$. This distribution of frequencies is plotted in figure 2.15:

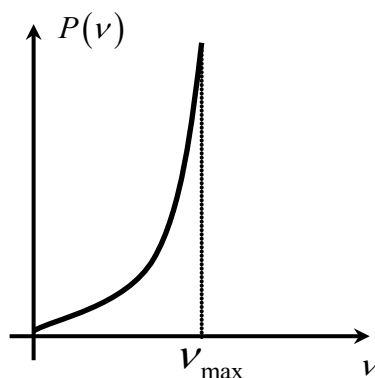

Fig. 2.15: frequency spectrum of the oscillations of a solid

The consequence of this improved model developed by Debye is that oscillations of lower frequencies are already accessible at lower temperatures. Therefore, the heat capacity at lower temperatures is larger than predicted by Einstein, and in agreement with the experimental results. Physically, the existence of lower frequencies is feasible if we consider the coupling of multiple atoms to one oscillator. The frequency of a harmonic oscillator depends on the mass which is moving, and the force which is constraining this movement. If you consider the coupling of atoms to an oscillating aggregate, the mass scales with the total number of atoms whereas the force only scales with the number of surface atoms. Consequently, the oscillatory frequency will decrease with increasing number of coupled atoms, vibration of the whole solid body showing the smallest frequency possible.

2.5 Phase equilibrium

2.5.1 Pure components, p-T-diagrams

The Gibbs phase rule states that, in any given system in equilibrium, the maximum number of intensive variables (= variables which do not depend on the size of the system, i.e. temperature, pressure) which can be freely chosen without altering the state of the system is given as $F = K - P + 2$, with K the number of chemical components and P the number of phases in coexistence. F is also called “degrees of freedom”. For example, for an ideal gas we get $P = 1$ and $K = 1$, therefore $F = 2$, meaning you can choose temperature T and pressure p independently without changing the state of the system, i.e. ideal gas. On the other hand, for real matter at its triple point we get $K = 1$ and $P = 3$, therefore $F = 0$, i.e. no intensive variable can be chosen.

The p - T -diagram of a real substance is shown in figure 2.16. It consists (at least!) of three different regions for the different phases solid, liquid and vapor, and three different equilibrium curves which pair-wise separate these regions. All three curves meet in one point, the triple point, where all three phases are in equilibrium.

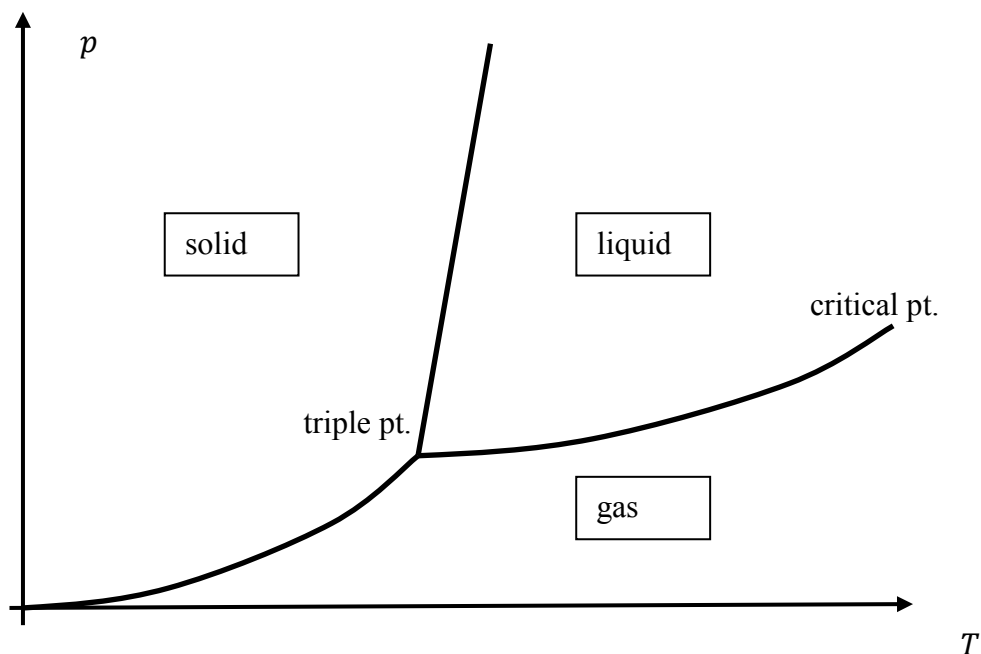

Fig. 2.16: p - T -phase diagram

Let us start with the liquid-gas-equilibrium, where $F = K - P = 1$, meaning we can either choose the pressure or the temperature independently. To obtain the relation between these two variables $p(T)$, the vapor pressure curve, we start with the equilibrium condition that the free Gibbs enthalpies of the coexisting phases (1 = liquid, 2 = vapor) have to be equal, choosing (arbitrarily) 1 mole substance for each phase. Here, one should note that the equilibrium conditions p , T will not depend on the amount of matter considered in each phase. E.g., at normal pressure water always boils at 100°C irrespective of the amount:

$$G_1 = G_2 \quad (\text{Eq.2.73})$$

Note that Eq.(2.73) is directly related to the 2nd law of thermodynamics: for spontaneous processes or non-equilibrium $\Delta S \geq \frac{Q}{T}$. This yields, in case of isobaric and isothermal conditions or at given p , T that $\Delta S \geq \frac{\Delta H}{T}$, or $\Delta G = \Delta H - T\Delta S \leq 0$, i.e. the condition of stationary equilibrium. If we follow the vapor pressure curve shown in figure 2.16, the respective free enthalpies of the two coexisting phases will change with temperature and pressure. However, since at any given point of the curve the stationary phase equilibrium is maintained, these respective changes in free enthalpy have to be equal, leading to:

$$dG_1 = -S_1 dT + V_1 dp = dG_2 = -S_2 dT + V_2 dp \quad (\text{Eq.2.74})$$

Taking into account that the molar volume of the vapor phase exceeds that of the liquid phase by 3 orders of magnitude, and inserting the ideal gas equation for V_2 , we obtain, after separating the variables:

$$dp = \frac{S_2 - S_1}{V_2} dT = \frac{T \cdot S_2 - T \cdot S_1}{T \cdot V_2} dT = \frac{\Delta_V H}{T \cdot V_2} dT = \frac{\Delta_V H}{R} \cdot \frac{dT}{T^2} \cdot p \quad (\text{Eq.2.75})$$

Integration from the triple point coordinates (T_0, p_0) to an arbitrary point on the vapor pressure curve leads to the Clausius-Clapeyron-equation:

$$\ln\left(\frac{p}{p_0}\right) = \frac{\Delta_V H}{R} \cdot \left(\frac{1}{T_0} - \frac{1}{T}\right) \quad (\text{Eq.2.76})$$

Alternatively, any point on the vapor pressure curve (T_0, p_0) can be chosen as reference, for instance the boiling temperature at standard pressure 1 atm. The Clausius-Clapeyron-equation allows one to predict the boiling behavior of a given pure substance. Note that boiling, corresponding to crossing the vapor-pressure curve from liquid to vapor regime, can be achieved in two different ways: either increasing the temperature at given pressure, or lowering the pressure at a given temperature (vacuum distillation).

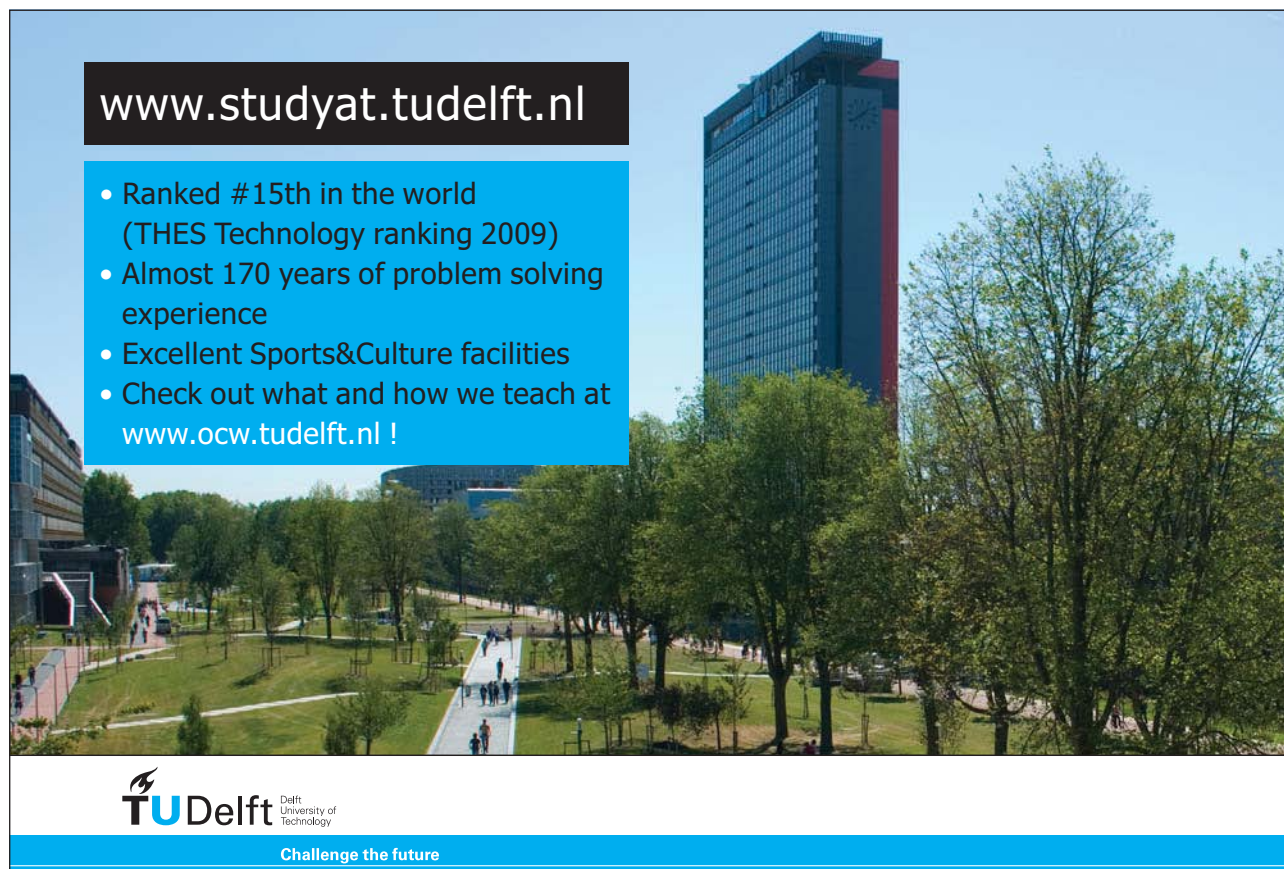

www.studyat.tudelft.nl

- Ranked #15th in the world (THES Technology ranking 2009)
- Almost 170 years of problem solving experience
- Excellent Sports&Culture facilities
- Check out what and how we teach at www.ocw.tudelft.nl !

TU Delft Delft University of Technology
Challenge the future

Sublimation, the phase transition from solid to vapor, can be described exactly the same way as the liquid-vapor transition, since again the molar volume of the vapor phase exceeds that of the condensed phase by several orders of magnitude. We simply consider 1 to be the solid phase, replace the evaporation enthalpy by the sublimation enthalpy, and get in analogy to the Clausius-Clapeyron-equation:

$$\ln\left(\frac{p_0}{p}\right) = \frac{\Delta_{sub}H}{R} \cdot \left(\frac{1}{T} - \frac{1}{T_0}\right) \quad (\text{Eq.2.77})$$

Note that, if our reference point is the triple point, this time we chose the variable point as the lower integration boundary, since the sublimation curve runs from the triple point to the left in the p-T-diagram.

Finally, let us consider the solid-liquid equilibrium. Here, we have to consider both the volume of the liquid and the solid phase. At not too high pressure, these volumes will be constant due to the very low compressibility of a condensed phase, and the equilibrium condition $dG_1 = dG_2$ (here: 1 = solid, 2 = liquid) after separation of the variables leads to:

$$dp = \frac{\Delta_s H}{\Delta_s V} \cdot \frac{dT}{T} \quad (\text{Eq.2.78})$$

or:

$$p = p_0 + \frac{\Delta_s H}{\Delta_s V} \cdot \ln\left(\frac{T}{T_0}\right) \quad (\text{Eq.2.79})$$

Again, we chose the triple point as the reference (T_0, p_0) since it is common to all three phase equilibria curves. Note that the variable point (T, p) on the melting curve, as shown in the figure, has to be above the triple point or at higher pressure. However, if the molar volume of the liquid phase is smaller than that of the solid phase, as for example in case of water, the melting temperature T is smaller than T_0 (anomalous behavior). As a consequence, one can melt water by applying pressure (see ice skating), or fortunately for us (and for the fish) a lake or river freezes from the top, thereby partially isolating itself from the cold air of the environment and rarely freezing completely.

We can simplify the melting curve expression if we consider that the melting temperature changes only slightly with increasing pressure, and using a Taylor series expansion for the logarithm:

$$p = p_0 + \frac{\Delta_s H}{\Delta_s V} \cdot \ln\left(\frac{T}{T_0}\right) = p_0 + \frac{\Delta_s H}{\Delta_s V} \cdot \ln\left(1 + \frac{T-T_0}{T_0}\right) \approx p_0 + \frac{\Delta_s H}{\Delta_s V} \cdot \frac{T-T_0}{T_0} \quad (\text{Eq.2.80})$$

This is a linear expression for p(T). Note that the slope of the melting line depends on $\Delta_s V$ which is typically positive (volume of the liquid phase is larger than that of the solid one), but can be negative (anomalous behavior, for example water!).

2.5.2 Partial molar quantities, the chemical potential

Before we discuss the phase behavior of multi-component systems, for example solutions or mixtures, we have to introduce a new type of physical-chemical quantities, partial molar quantities. We will mainly use the partial molar free enthalpy or chemical potential, but the difference between pure components characterized by molar quantities, and mixture characterized by their partial molar correspondents, is best illustrated via the molar volume.

(i) Partial molar quantities, the partial molar volume

In the ideal case, the total volume of a binary mixture is given by the respective sum of the molar volumes of the pure components times the mole number of each component, respectively:

$$V = n_1 \cdot V_1^0 + n_2 \cdot V_2^0 \quad (\text{Eq.2.81})$$

However, in most cases specific interactions between the two types of molecules lead to a volume change after mixing, which can be expressed by an excess term as:

$$V = n_1 \cdot V_1^0 + n_2 \cdot V_2^0 + \Delta V_{mix} = n_1 \cdot V_1 + n_2 \cdot V_2 \quad (\text{Eq.2.82})$$

Here, the excess term corresponds to the total difference of the molar volumes of the pure components and the so-called partial molar volumes, which have to be used to describe the total volume of a real mixture:

$$\Delta V_{mix} = n_1 \cdot (V_1 - V_1^0) + n_2 \cdot (V_2 - V_2^0) \quad (\text{Eq.2.83})$$

The practical meaning of these partial molar volumes is illustrated by the following fictional experiment: take a given binary mixture to which we add an infinitesimally small amount of the two components 1 and 2, respectively. The corresponding change in volume then is given as

$$dV = \left(\frac{\partial V}{\partial n_1}\right) dn_1 + \left(\frac{\partial V}{\partial n_2}\right) dn_2 = V_1 dn_1 + V_2 dn_2 \quad (\text{Eq.2.84})$$

The partial molar volumes therefore correspond to the partial derivatives of the total volume over the molar amount of the respective component. Next, we consider a macroscopic volume consisting of many of these infinitesimal volume changes dV , where the composition dn_1, dn_2 is identical for all dV :

$$V = \sum dV = V_1 \sum dn_1 + V_2 \sum dn_2 = V_1 n_1 + V_2 n_2 \quad (\text{Eq.2.85})$$

Here, it should be stressed that the partial molar volumes only depend on the relative composition of the mixture, and not on the absolute amounts of the components!

Taking the differential of this expression we get:

$$dV = d(V_1 n_1 + V_2 n_2) = dV_1 n_1 + V_1 dn_1 + dV_2 n_2 + V_2 dn_2 \quad (\text{Eq.2.86})$$

On the other hand, we have shown before that

$$dV = \left(\frac{\partial V}{\partial n_1}\right) dn_1 + \left(\frac{\partial V}{\partial n_2}\right) dn_2 = V_1 dn_1 + V_2 dn_2 \quad (\text{Eq.2.87})$$

Combining these two expressions for dV , we obtain the important Gibbs-Duhem-equation

$$dV_1 n_1 + dV_2 n_2 = 0, \text{ or } n_1 dV_1 = -n_2 dV_2 \quad (\text{Eq.2.88})$$

This equation enables us to calculate the dependence of the partial molar volume of one component on the composition of a binary mixture, if we measure this dependence for the other component. To measure the partial molar volume of component 2, for example, one has to measure the total volume of the mixture while only varying the amount of component 2, keeping the other variables n_1 , pressure and temperature constant. The partial molar volume V_2 then is obtained as the tangential slope of a plot of total volume V versus n_2 , i.e.

$$V_2 = \left(\frac{\partial V}{\partial n_2}\right)_{p,T,n_1} \quad (\text{Eq.2.89})$$

"I studied English for 16 years but...
...I finally learned to speak it in just six lessons"
Jane, Chinese architect

ENGLISH OUT THERE

Click to hear me talking before and after my unique course download

Note that this slope could be negative, as for example in case of pure water to which we add NaOH: here, the formation of a more densely packed hydration shell leads to an overall contraction of the volume if the amount of added NaOH is still small.

(ii) The chemical potential

Fundamentally much more important than the partial molar volume is the partial molar free enthalpy, which is also called the chemical potential, and provides us with the criterion for phase equilibrium of multi-component systems:

$$\mu_1 = \left(\frac{\partial G}{\partial n_1} \right)_{p,T,n_2} \quad (\text{Eq.2.90})$$

Note that for a pure component ($n_2 = 0$), this chemical potential is simply the molar free enthalpy. The chemical potential is the key quantity in the discussion of both phase equilibrium and chemical equilibrium of mixtures, like the free enthalpy for the pure component phase equilibrium as we have shown before. The equilibrium conditions for mixtures are $\mu'_1 = \mu''_1$ (stationary) and $d\mu'_1 = d\mu''_1$, respectively. The expression for the dependence of the chemical potential on the sample composition of a binary mixture can easily be derived if we consider the mixing process of two different ideal gases A, B. Note that therefore we will ignore any enthalpic contributions or specific interactions, and therefore the difference between molar free enthalpy G and partial molar free enthalpy μ will only depend on the mixing entropy!

(iii) Mixing free enthalpy of two ideal gases and the chemical potential

Before we will treat the phase equilibria of multicomponent systems or mixtures, we will derive an expression for the chemical potential by considering the following mixing process of two different ideal gases, as sketched in figure 2.17.

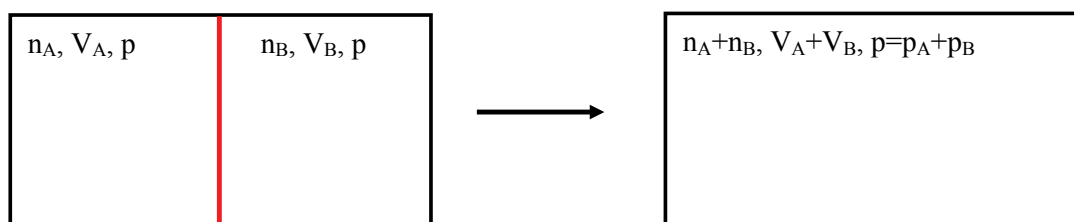

Fig. 2.17: Spontaneous mixing of two different ideal gases to deduce the free enthalpy of mixing

Before mixing, both gases with molar amount n_A and n_B , respectively, shall have the same pressure p . The chemical potential, or molar free enthalpy, of gas A before mixing then is given as:

$$\mu_A^*(p) = \mu_A^{*,\emptyset} + \int_{p^\emptyset}^p V dp = \mu_A^{*,\emptyset} + \int_{p^\emptyset}^p \frac{RT}{p} dp = G_{A,molar}(p) \quad (\text{Eq.2.91})$$

Here, the symbol $*$ signifies pure component, and signifies standard conditions, i.e. here it refers to the standard pressure of $p = 1$ bar. The total free enthalpy of our system before mixing (figure 2.17, left) is therefore given as

$$G = n_A \mu_A^* + n_B \mu_B^* = n_A \left(\mu_A^{*,\emptyset} + RT \cdot \ln \frac{p}{p^\emptyset} \right) + n_B \left(\mu_B^{*,\emptyset} + RT \cdot \ln \frac{p}{p^\emptyset} \right) \quad (\text{Eq.2.92})$$

After mixing, the two gases assume their respective partial pressures given by the molar fractions, i.e.

$$p_A = \frac{n_A}{n_A + n_B} \cdot p = x_A \cdot p, \quad p_B = \frac{n_B}{n_A + n_B} \cdot p = x_B \cdot p \quad (\text{Eq.2.93})$$

The total free enthalpy after mixing therefore is given as

$$G' = n_A \left(\mu_A^{*,\emptyset} + RT \cdot \ln \frac{p_A}{p^\emptyset} \right) + n_B \left(\mu_B^{*,\emptyset} + RT \cdot \ln \frac{p_B}{p^\emptyset} \right) \quad (\text{Eq.2.94})$$

and the free enthalpy of mixing is

$$\Delta_m G = G' - G = n_A RT \ln \frac{p_A}{p} + n_B RT \ln \frac{p_B}{p} = nRT (x_A \ln x_A + x_B \ln x_B) \quad (\text{Eq.2.95})$$

Note that the expression in brackets is negative. Therefore the free enthalpy of mixing is always < 0 , which is obvious since the mixing of two ideal gases is an irreversible spontaneous process.

Since we have considered here only entropic effects, the enthalpy of mixing has to be zero, and the mixing entropy is simply given as:

$$\Delta_m S = - \left(\frac{d\Delta_m G}{dT} \right) = -nR (x_A \ln x_A + x_B \ln x_B) \quad (\text{Eq.2.96})$$

This is always > 0 , which is obvious for an irreversible spontaneous process according to the 2nd fundamental principle of thermodynamics.

In the following, we will use this general expression for the chemical potential of an ideal purely entropic mixture irrespective of its state (gas, liquid or solid):

$$\mu_A = \mu_A^* + RT \ln x_A \quad (\text{Eq.2.97})$$

Note again that μ_A^* refers to the pure component at identical pressure and temperature as the mixture, and therefore is the molar free enthalpy $G_{A,molar}$.

2.5.3 Phase behavior of binary systems – liquid-vapor-transition

We start with a liquid mixture containing only one evaporative component, the solvent, and will derive a formula for the increase in boiling temperature in respect to that of the pure solvent. This system is formally sketched in figure 2.18.

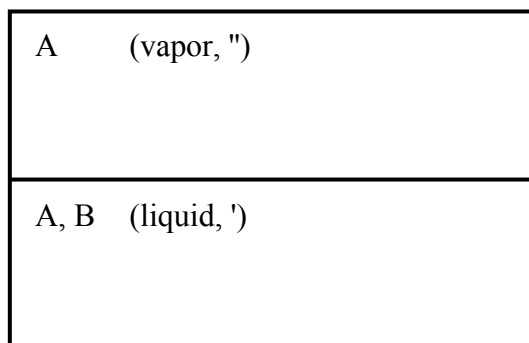

Fig. 2.18: Phase equilibrium between a binary liquid mixture and the pure vapor of the volatile component A

At equilibrium, the chemical potentials of component A, which coexists in both the vapor and the liquid phase, have to be identical, respectively, or

$$\mu_A' = \mu_A'' \quad (\text{Eq.2.98})$$

Study at one of Europe's leading universities



DTU, Technical University of Denmark, is ranked as one of the best technical universities in Europe, and offers internationally recognised Master of Science degrees in 39 English-taught programmes.

DTU offers a unique environment where students have hands-on access to cutting edge facilities and work

closely under the expert supervision of top international researchers.

DTU's central campus is located just north of Copenhagen and life at the University is engaging and vibrant. At DTU, we ensure that your goals and ambitions are met. Tuition is free for EU/EEA citizens.

Visit us at www.dtu.dk



Since we are interested in the dependence of boiling temperature on concentration of component B in the liquid phase, we have to use the derivative, or:

$$d\mu'_A = d\mu''_A \quad (\text{Eq.2.99})$$

To avoid differentiation of the expression $RT \ln x_A$ which is part of the chemical potential of the binary liquid phase, we consider alternatively

$$d\frac{\mu'_A}{T} = d\frac{\mu''_A}{T} \quad (\text{Eq.2.100})$$

$$d\frac{\mu''_{A^*}}{T} + R \cdot d \ln x'_A = d\frac{\mu''_{A^*}}{T} \quad (\text{Eq.2.101})$$

Note that the pressure in this case is kept constant, the only intensive variable being the boiling temperature T and the concentration or molar fraction of the solvent in the liquid phase x'_A .

To solve this differential equation and thereby obtain a quantitative relation between phase transition temperature and solute concentration, we need the total differential of $\frac{G}{T}$, which is given as:

$$d\left(\frac{G}{T}\right) = -\frac{H}{T^2}dT + \frac{V}{T}dp \quad (\text{Eq.2.102})$$

Noting that $\mu''_{A^*} = G'_{A,molar} = G'_A$, we obtain

$$-\frac{H'_A}{T^2}dT + R \cdot d \ln x'_A = -\frac{H''_{A^*}}{T^2}dT \quad (\text{Eq.2.103})$$

$$\left(\frac{H''_{A^*}}{T^2} - \frac{H'_A}{T^2}\right)dT = \frac{\Delta_V H_A}{T^2}dT = -R \cdot d \ln x'_A \quad (\text{Eq.2.104})$$

with $\Delta_V H_A$ the molar evaporation enthalpy of component A. Integration with the boundaries pure solvent ($T = T_{A^*}$, $x'_A = 1$, $p = 1$ bar) and an arbitrary mixture (T , x'_A , $p = 1$ bar), we finally get:

$$\frac{\Delta_V H_A}{R} \left(-\frac{1}{T} + \frac{1}{T_{A^*}}\right) = -\ln x'_A \quad (\text{Eq.2.105})$$

Note that $T > T_{A^*}$, i.e. the mixture has a higher boiling temperature than the pure solvent. Also, this effect is purely of entropic origin, since our derivation is based on the chemical potential using the formula we previously have deduced from the mixing free enthalpy of ideal gases. Therefore, the effect also does not depend on the chemical nature of the solute component B, but only on the relative concentration, or better, the molar fraction of the solvent in the liquid phase x'_A .

This type of entropy-based effect found in binary mixtures is also called a colligative phenomenon, further examples are lowering of the freezing temperature (see next chapter), lowering of the vapor pressure which is the direct correspondent of the increase in boiling temperature (law of Raoult), and finally osmotic pressure. All respective mathematical expressions are derived from the same principle, i.e. the equality of the chemical potential of the solvent component in both coexisting phases $\mu'_A = \mu''_A$. This leads us to an alternative derivation of the increase of boiling temperature formula merely based on this stationary phase equilibrium $\mu'_A = \mu''_A$ and avoiding the explicit mathematical solution of any differential equation:

We start with the stationary phase equilibrium given as:

$$\mu'_A * + RT \cdot \ln x'_A = \mu''_A * \quad (\text{Eq.2.106})$$

and therefore, using the Gibbs-Helmholtz-expression $\Delta_V G_A = \Delta_V H_A - T \Delta_V S_A$:

$$\mu''_A * - \mu'_A * = \Delta_V G_A = \Delta_V H_A - T \Delta_V S_A = RT \cdot \ln x'_A \quad (\text{Eq.2.107})$$

with $\Delta_V H_A$ the molar evaporation enthalpy of the pure solvent, and $\Delta_V S_A$ the molar evaporation entropy. The evaporation entropy, defined as the reversible heat uptake normalized by the evaporation temperature, can simply be replaced if we consider this equation at the boundary case of the pure solvent ($T = T_A *$, $x'_A = 1$, $p = 1$ bar):

$$\Delta_V H_A - T_A * \cdot \Delta_V S_A = RT \cdot \ln 1 = 0, \text{ or } \Delta_V S_A = \frac{\Delta_V H_A}{T_A *} \quad (\text{Eq.2.108})$$

and we immediately obtain our above result

$$\frac{\Delta_V H_A}{R} \left(-\frac{1}{T} + \frac{1}{T_A *} \right) = -\ln x'_A \quad (\text{Eq.2.109})$$

Note that this expression can further be simplified if we consider very dilute solutions, i.e. comparatively small values of $x'_B = 1 - x'_A$, and use the Taylor series expansion of the logarithm:

$$\frac{\Delta_V H_A}{R} \left(-\frac{1}{T} + \frac{1}{T_A *} \right) = -\ln(1 - x'_B) \approx x'_B \quad (\text{Eq.2.110})$$

Also the left hand side of this equation can be simplified considering that the change in boiling temperature $\Delta T = T - T_A *$ will be comparatively small for such dilute systems:

$$\frac{\Delta_V H_A}{R} \left(-\frac{1}{T} + \frac{1}{T_A *} \right) = \frac{\Delta_V H_A}{R} \left(\frac{T - T_A *}{T_A * \cdot T} \right) \approx \frac{\Delta_V H_A}{R} \left(\frac{\Delta T}{T_A *^2} \right) = x'_B \quad (\text{Eq.2.111})$$

Finally, we will get the following simple formula for the colligative phenomenon of boiling temperature increase:

$$\frac{\Delta_V H_A}{R} \left(\frac{\Delta T}{T_A^{*2}} \right) = x'_B \approx \frac{n'_B}{n_A} = \frac{\frac{m'_B}{M_B}}{\frac{m_A}{M_A}} = \frac{m'_B}{M_B} \cdot \frac{M_A}{m_A} \quad (\text{Eq.2.112})$$

Or

$$\Delta T = \frac{R \cdot T_A^{*2} \cdot M_A}{\Delta_V H_A} \cdot \frac{m'_B}{M_B} \cdot \frac{1}{m_A} \quad (\text{Eq.2.113})$$

Here, n'_B is the molar amount of solute in the mixture, m'_B the solute mass and M_B the molar mass of the solute, index A accordingly for the solvent component in the mixture. The effect ΔT is therefore, in case of dilute solutions, directly proportional to the molal concentration of the solute B , and it does not depend on the chemical nature of the solute but only on that of the solvent, with the proportionality factor, also called ebullioscopic constant, given as $\frac{R \cdot T_A^{*2} \cdot M_A}{\Delta_V H_A}$.



MSM

MAASTRICHT SCHOOL OF MANAGEMENT

Increase your impact with MSM Executive Education





For almost 60 years Maastricht School of Management has been enhancing the management capacity of professionals and organizations around the world through state-of-the-art management education.

Our broad range of Open Enrollment Executive Programs offers you a unique interactive, stimulating and multicultural learning experience.

Be prepared for tomorrow's management challenges and apply today.

For more information, visit www.msm.nl or contact us at +31 43 38 70 808 or via admissions@msm.nl

the globally networked management school



Next, we consider the liquid-vapor-equilibrium of a binary mixture where both components A and B are volatile, as sketched below:

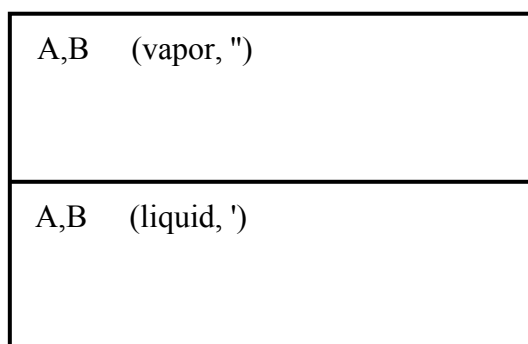

Fig. 2.19: Phase equilibrium between a binary liquid mixture and the vapor mixture in case both components are volatile

The vapor pressure of the liquid phase then is given by Raoult's law, i.e. summing up the reduced (in respect to the pure liquid) vapor pressures of both components A and B

$$p = x'_A \cdot p_A^* + x'_B \cdot p_B^* = x'_A \cdot p_A^* + (1 - x'_A) \cdot p_B^* = p_B^* + (p_A^* - p_B^*) \cdot x'_A \quad (\text{Eq.2.114})$$

This linear equation describes the boiling line, with the two intercepts p_A^* and p_B^* the vapor pressures of the pure liquid, respectively.

For the composition of the vapor phase we use Dalton's law, which describes the partial pressure of component A as:

$$p_A = x''_A \cdot p \quad (\text{Eq.2.115})$$

At equilibrium for two coexisting phases, the overall pressure as well as the pressure per component must be identical for liquid and vapor state. Therefore, we simply may insert the linear equation for p into Dalton's law, and obtain either a relation for the composition of the vapor phase in respect to that of the liquid phase (= coexistence curve), or for the gas pressure as a function of vapor composition (condensation curve):

$$x''_A = \frac{x'_A p_A^*}{p_B^* + (p_A^* - p_B^*) x'_A} \quad (\text{Eq.2.116})$$

$$p = \frac{p_A^* p_B^*}{p_A^* + (p_B^* - p_A^*) x''_A} \quad (\text{Eq.2.117})$$

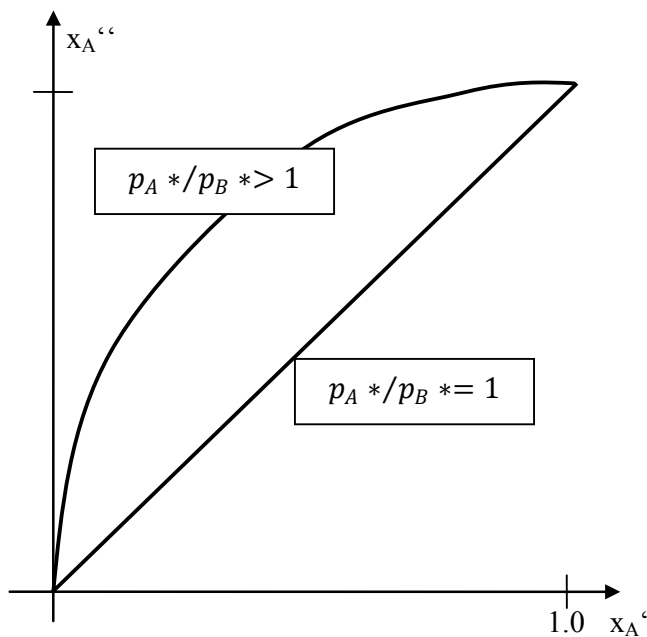

Figure 2.20: Coexistence curves – compositions of liquid and corresponding vapor phase

The figure shows some examples: if both components have the same volatility, i.e. $p_A^* = p_B^*$, the composition of the liquid and the vapor phase is identical, and distilling leads to no fractionation of the liquid mixture. On the other hand, if one component has a higher volatility, e.g. $p_A^* > p_B^*$, the more volatile component A becomes enriched in the vapor phase upon vacuum distillation ($x_A'' > x_A'$).

If you combine the boiling line and the condensation curve (Eqs.2.114 and 2.117), you get the isotherm phase diagram of boiling for an ideal, i.e. purely entropic, binary mixture.

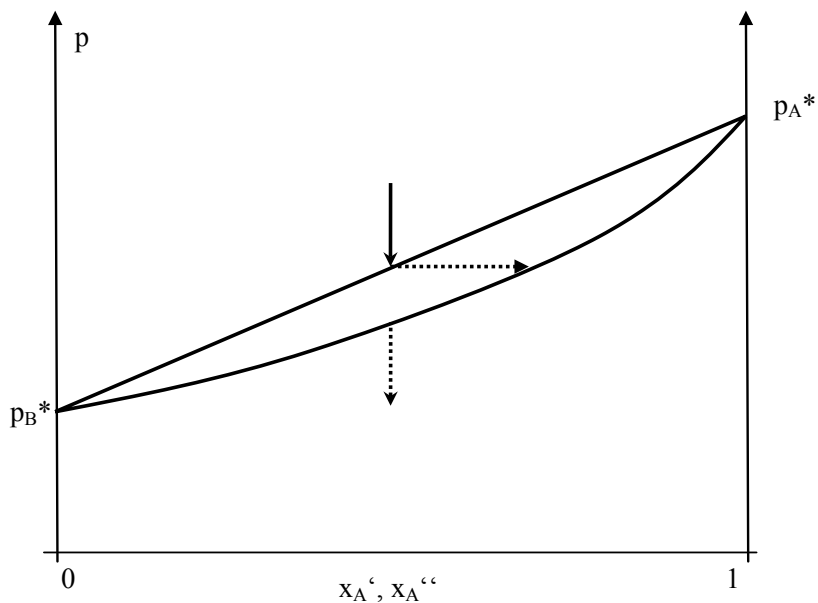

Fig. 2.21: Isothermal boiling curve of an ideal binary mixture, and the principle of distillation

The average composition of the whole system comprising both liquid and vapor is given as

$$z_A = \frac{N' \cdot x'_A + N'' \cdot x''_A}{N} \quad (\text{Eq.2.118})$$

with N' the total amount of particles (both A and B!) in the liquid phase, and N'' correspondingly the total amount of particles in the vapor phase. Boiling line and condensation curve enclose the two-phase-region, where liquid and vapor phase coexist, with respective compositions given by the horizontal intersection with the boiling line or condensation curve, respectively.

Finally, the arrows inserted in figure 2.21 illustrate how a vacuum distillation proceeds: if the pressure becomes smaller than the limit defined by the boiling line, we get the formation of vapor enriched in the component A of higher volatility. Further lowering the pressure leads to a decrease in component A in the liquid phase, but, if all vapor is collected in the same flask, also a decrease in A in the vapor phase compared to the first vapor formed, until all liquid has been evaporated and the overall vapor composition corresponds to the composition of the original liquid mixture. This also illustrates the obvious fact that, if distillation is used for purification of a liquid, one has to collect the vapor in different flasks successively (fractionation).

gaiTeye
Challenge the way we run

EXPERIENCE THE POWER OF FULL ENGAGEMENT...

**RUN FASTER.
RUN LONGER..
RUN EASIER...**

**READ MORE & PRE-ORDER TODAY
WWW.GAITEYE.COM**

For fractionated distillation, you can either lower the pressure, in which case you need the isothermal boiling phase diagram to predict the process, or you can increase the temperature. This leads us to the isobar boiling phase diagram sketched in figure 2.22. The corresponding equations are derived from the stationary equilibrium condition $\mu'_A = \mu''_A$, analogous to the colligative phenomenon of increase in boiling temperature derived before (see Eq.2.98).

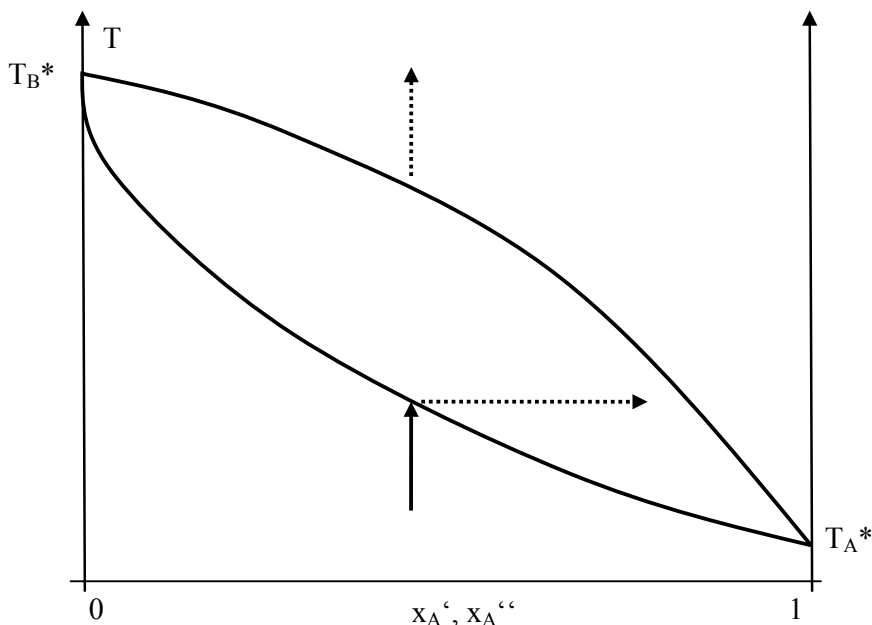

Fig. 2.22: Isobar boiling curve of an ideal binary mixture, and the principle of distillation

The only difference is that this time both the vapor and the liquid phase are a mixed phase, therefore:

$$\mu'_A * + RT \cdot \ln x'_A = \mu''_A * + RT \cdot \ln x''_A \tag{Eq.2.119}$$

or

$$\mu''_A * - \mu'_A * = \Delta_V G_A = \Delta_V H_A - T \cdot \Delta_V S_A = RT \cdot \ln x'_A - RT \cdot \ln x''_A = RT \cdot \ln \frac{x'_A}{x''_A} \tag{Eq.2.120}$$

Using again the pure liquid A as boundary condition, we can replace the entropy:

$$\Delta_V H_A - T_A * \cdot \Delta_V S_A = RT_A * \cdot \ln \frac{1}{1} = 0 \quad , \quad \Delta_V S_A = \frac{\Delta_V H_A}{T_A *} \tag{Eq.2.121}$$

And finally we get:

$$\ln \frac{x'_A}{x''_A} = \frac{\Delta_V H_A}{R} \cdot \frac{T - T_A *}{T \cdot T_A *} \tag{Eq.2.122}$$

And analogous for the 2nd component B:

$$\ln \frac{x'_B}{x''_B} = \frac{\Delta_V H_B}{R} \cdot \frac{T - T_B *}{T \cdot T_B *} \tag{Eq.2.123}$$

Inserting $x'_B = 1 - x'_A$, $x''_B = 1 - x''_A$, and replacing x''_A , we finally obtain the following relative complicated expression for the isobar boiling curve:

$$x'_A = \frac{1 - \exp\left[\frac{\Delta_V H_B}{R} \cdot \left(\frac{1}{T_B^*} - \frac{1}{T}\right)\right]}{\exp\left[\frac{\Delta_V H_A}{R} \cdot \left(\frac{1}{T_A^*} - \frac{1}{T}\right)\right] - \exp\left[\frac{\Delta_V H_B}{R} \cdot \left(\frac{1}{T_B^*} - \frac{1}{T}\right)\right]} \quad (\text{Eq.2.124})$$

Importantly, T_A^* and T_B^* in this formula are the boiling temperatures of the respective pure components at the pressure of the experiment, which is not necessarily the standard pressure 1 bar!

Note that we can derive this expression in a much simpler way if we insert the Clausius-Clapeyron-equation, connecting vapor pressure and boiling temperature of the pure components, i.e.:

$$\ln\left(\frac{p_X^*(T)}{p_X^*(T_X^*)}\right) = \frac{\Delta_V H_X}{R} \cdot \left(\frac{1}{T_X^*} - \frac{1}{T}\right), \quad p_X^*(T) = p_X^*(T_X^*) \cdot \exp\left[\frac{\Delta_V H_X}{R} \cdot \left(\frac{1}{T_X^*} - \frac{1}{T}\right)\right] \quad (\text{Eq.2.125})$$

into the isothermal boiling curve, with $p = p_X^*(T_X^*)$ the actual laboratory pressure or boiling pressure (i.e.: at $T = T_X^*$ we have $p = p_X^*$ and therefore the pure liquid X would be boiling)

$$x'_A = \frac{p - p_B^*}{p_A^* - p_B^*} \quad (\text{Eq.2.126})$$

Finally, we consider a non-ideal mixture, where the interparticle attraction between molecules of component A and B is weaker than the intermolecular attraction between molecules of the same species (A or B). In this case we find a minimum in the boiling curve (see figure 2.23).

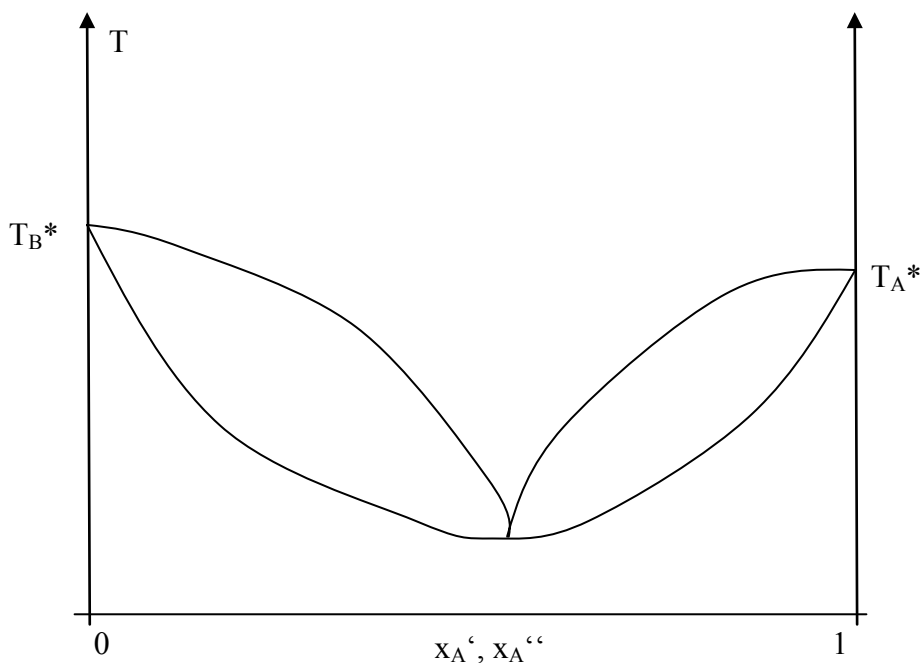

Fig. 2.23: Isobaric boiling curve of an azeotropic binary mixture (azeotropic minimum, e.g. water/ethanol)

This type of interactions destabilizes the liquid phase, and therefore shifts the boiling temperature towards lower values in comparison to the boiling point of pure components A or B, respectively. As a consequence, the boiling curve intersects with the condensation curve at the minimum, and a knot is formed in the two-phase-region, also called azeotropic point. At this composition, the vapor upon boiling shows the identical composition as the liquid phase, and no purification by distillation is possible. An example of this type of maximum-azeotrop is the mixture $\text{H}_2\text{O}/\text{EtOH}$.

If the interactions between molecules of type A and B are stronger than the attractive interactions A-A or B-B, the azeotrop is a maximum in the condensation curve, and the boiling curve forms the knot. An example of this type of azeotrop is a mixture of H_2O and HNO_3 .

DESTINATIONS		GATE	ARRIVAL
INDUSTRY	IMPACT	OW	FASTER
GLOBAL	ASSIGNMENTS	OW	FASTER
SENIOR	CLIENT CONTACT	OW	FASTER
CAREER	DEVELOPMENT	OW	FASTER
MAKE	PARTNER	OW	FASTER

OLIVER WYMAN



Oliver Wyman is a leading global management consulting firm that combines deep industry knowledge with specialized expertise in strategy, operations, risk management, organizational transformation, and leadership development. With offices in 50+ cities across 25 countries, Oliver Wyman works with the CEOs and executive teams of Global 1000 companies.

DISCOVER
OUR WORLD

An equal opportunity employer.

GET THERE FASTER

Some people know precisely where they want to go. Others seek the adventure of discovering uncharted territory. Whatever you want your professional journey to be, you'll find what you're looking for at Oliver Wyman.

Discover the world of Oliver Wyman at oliverwyman.com/careers



Click on the ad to read more

2.5.4 Phase behavior of binary systems – solid-liquid-transition

We start again with the simplest case: a binary mixture of components A and B in equilibrium with a pure solid of component A.

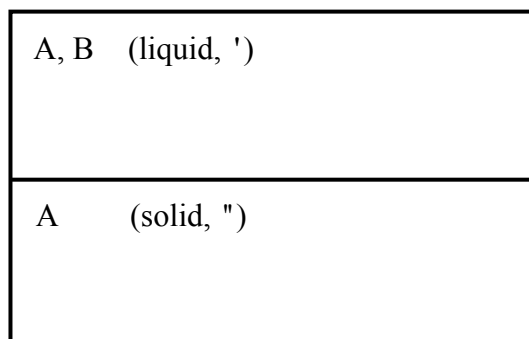

Fig. 2.24: Phase equilibrium between a binary liquid mixture A, B, and the pure solid of the component (A)

As in case of the liquid-vapor equilibrium discussed before, the chemical potentials of component A, which coexists in both the liquid and the solid phase, have to be identical, respectively, or

$$\mu'_A = \mu''_A \quad (\text{Eq.2.127})$$

Since we are interested in the dependence of melting temperature on concentration of component B in the liquid phase, we have to use the derivative, or:

$$d\mu'_A = d\mu''_A \quad (\text{Eq.2.128})$$

As before in case of the increase in boiling temperature of a binary liquid mixture, we get at constant pressure the relation:

$$\left(\frac{dT}{d \ln x'_A} \right)_p = \frac{RT^2}{H'_A - H''_A} = \frac{RT^2}{\Delta_S H_A} \quad (\text{Eq.2.129})$$

with $\Delta_S H_A$ the molar melting enthalpy of component A. Integration of this differential equation leads to

$$\frac{\Delta_S H_A}{R} \left(-\frac{1}{T} + \frac{1}{T_{A^*}} \right) = \ln x'_A \quad (\text{Eq.2.130})$$

Note that this expression again can further be simplified if we consider very dilute solutions, i.e. comparatively small values of $x'_B = 1 - x'_A$, and use the Taylor series expansion of the logarithm:

$$\frac{\Delta_S H_A}{R} \left(-\frac{1}{T} + \frac{1}{T_{A^*}} \right) = \ln(1 - x'_B) \approx -x'_B \quad (\text{Eq.2.131})$$

Also the left hand side of this equation can be simplified considering that the change in melting temperature $\Delta T = T - T_A^*$ will be comparatively small for such dilute systems:

$$\frac{\Delta_S H_A}{R} \left(-\frac{1}{T} + \frac{1}{T_A^*} \right) = \frac{\Delta_S H_A}{R} \left(\frac{T - T_A^*}{T_A^* T} \right) \approx \frac{\Delta_S H_A}{R} \left(\frac{-\Delta T}{T_A^{*2}} \right) = -x_B' \quad (\text{Eq.2.132})$$

Finally, we will get the following simple formula for the colligative phenomenon of melting temperature decrease:

$$\frac{\Delta_S H_A}{R} \left(\frac{\Delta T}{T_A^{*2}} \right) = x_B' \approx \frac{n_B'}{n_A} = \frac{\frac{m_B'}{M_B}}{\frac{m_A}{M_A}} = \frac{m_B'}{M_B} \cdot \frac{M_A}{m_A} \quad (\text{Eq.2.133})$$

or

$$\Delta T = \frac{R \cdot T_A^{*2} \cdot M_A}{\Delta_S H_A} \cdot \frac{m_B'}{M_B} \cdot \frac{1}{m_A} \quad (\text{Eq.2.134})$$

Here, n_B' is the molar amount of solute in the mixture, m_B' the solute mass and M_B the molar mass of the solute, index A accordingly for the solvent component in the mixture. The effect ΔT is therefore, in case of dilute solutions, directly proportional to the molal concentration of the solute B, and it does not depend on the chemical nature of the solute but only on that of the solvent, with the proportionality factor, also called cryoscopic constant, given as $\frac{R \cdot T_A^{*2} \cdot M_A}{\Delta_S H_A}$.

Consider the following experiment to measure the melting temperature: a beaker containing the liquid sample, either pure solvent or solution, is embedded with a cooling bath, say a water/ice-mixture including salt. In case the cooling process is very slow, the sample freezes at equilibrium conditions, and the following cooling curves are obtained for pure solvent and solution, respectively:

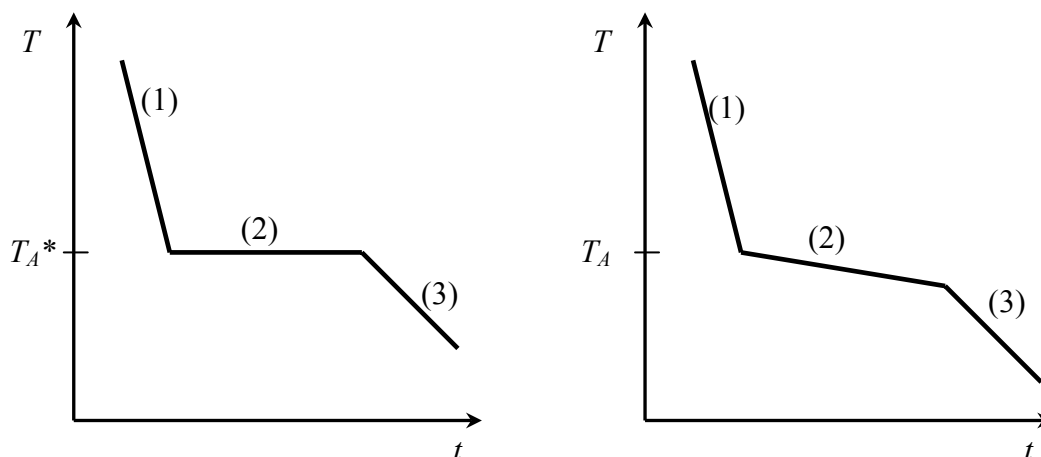

Fig. 2.24: Experimental cooling curves of pure liquid (left) and a binary mixture containing only one crystallizable component (right)

In case of the pure solvent, first the liquid is cooled until its freezing temperature is reached (1). At $T = T_A^*$, the solid phase is formed, and the temperature is kept constant until all liquid is frozen (2). Formally, at this stage the cooling is compensated by the heat of freezing, leading to a constant temperature. If all liquid is frozen, the pure solid is further cooled (3).

In case of the solution, first the freezing temperature T_A is lower than in case of the pure solvent due to the colligative phenomenon of lowering of the freezing temperature. In addition, the temperature is further decreasing once the freezing has started, since freezing of the solvent causes a further increase of the dissolved solute in the liquid phase, enhancing the colligative effect (2). Finally, once all solvent has frozen, a solid phase is further cooling (3).

Next, let us consider the case where both components A, B are freezing, but not forming a mixed crystal in the solid phase. In this case, the phase behavior is a combination of the system we have just discussed, i.e. freezing of only the solvent, where the role of the solvent is played either by component A or B, respectively.



Day one
and you're ready

Day one. It's the moment you've been waiting for. When you prove your worth, meet new challenges, and go looking for the next one. It's when your dreams take shape. And your expectations can be exceeded. From the day you join us, we're committed to helping you achieve your potential. So, whether your career lies in assurance, tax, transaction, advisory or core business services, shouldn't your day one be at Ernst & Young?

What's next for your future?
ey.com/careers

ERNST & YOUNG
Quality In Everything We Do

© 2010 EYGM Limited. All Rights Reserved.



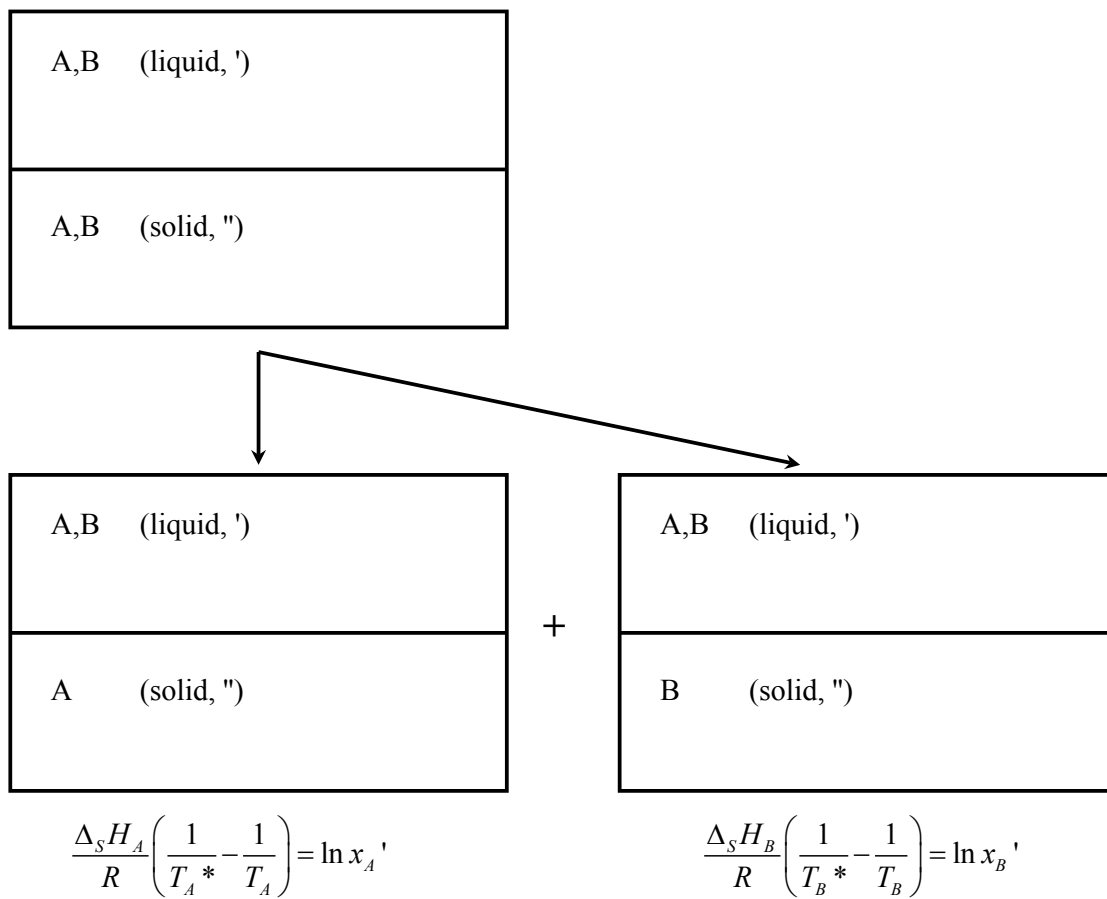

Fig. 2.25: Phase equilibrium between a binary liquid mixture and the solid phase in case both components may crystallize but do not form a mixed crystal

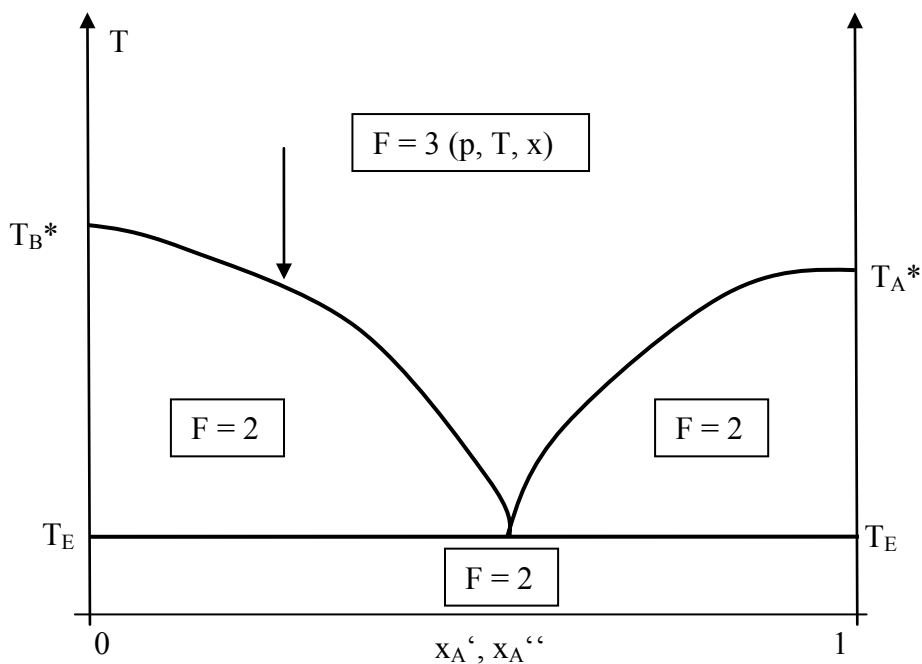

Figure 2.26: Isobar melting diagram of a binary mixture with Eutectic point

At small volume fractions of component B (left side of the diagram), A plays the role of the solvent: at $x_B = 0$ the transition from liquid to solid takes place at the freezing temperature of the pure component A ($T = T_A^*$), and it is decreasing with increasing x_B due to the increase in the colligative phenomenon of freezing temperature suppression. In this region, only component A is found in the solid phase! On the other hand, at large volume fraction x_B component B plays the role of the solvent: at $x_B = 1$ the freezing temperature is that of pure component B ($T = T_B^*$), decreasing with decreasing x_B (or increasing $x_A = 1 - x_B$) again following the increase of the colligative freezing point suppression.

Both freezing point suppression curves intersect at an intermediate concentration (in the figure at $x_B = 0.6$), the Eutectic point. Formally, this point correspond to the azeotropic knot in the phase diagram of boiling of a binary liquid mixture: at this temperature, both components A and B are freezing, but not mixing within the solid phase on a molecular level! At this point, therefore, the liquid mixture cannot be purified by crystallization.

Another aspect is the number of thermodynamic degrees of freedom, or independent intensive variables, also given in the figure: in the region of the pure liquid, $F = 3$, namely pressure, temperature and composition x_B . In the two-phase regions, F is only 2: at given temperature, the compositions of the liquid and the solid phase are defined, or, at given composition of the liquid phase, the melting temperature is defined. Therefore, x_B and T cannot be chosen independently without leaving the state of two coexisting phases. Note that in this region the composition of the solid phase is either simply $x_B = 1$ or $x_B = 0$. Finally, in the pure solid region, F also is only 2, since the composition of the two coexisting solid phases is $x_B = 1$ and $x_B = 0$, respectively.

This melting diagram leads to the following experimental cooling curve:

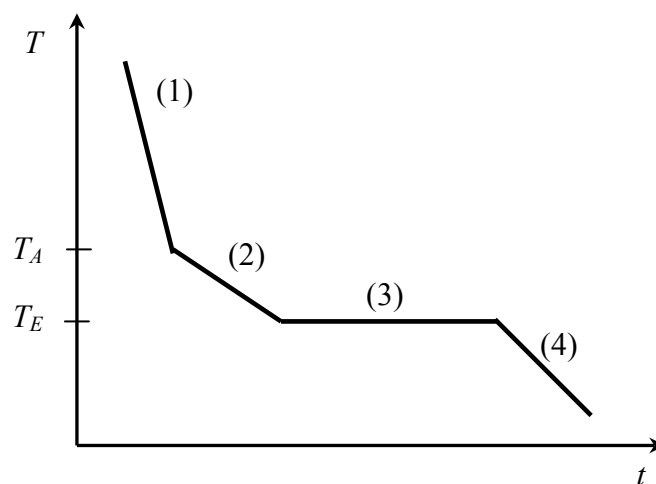

Figure 2.27: Experimental cooling curve for a binary mixture with Eutectic point

In region (1), the pure liquid is cooling until at $T = T_A$ the pure component A ($x_B = 0$) starts to freeze. In region (2), component A continues to freeze, leading to an increase of the solute component B in the liquid phase and consequently a further decrease of the freezing temperature, until, at the eutectic point, also component B starts to freeze. In region (3), both components A and B freeze and the composition of the liquid phase is kept constant at that of the eutectic point, wherefore in this region also the freezing temperature remains constant, until all liquid has frozen. Finally, in region (4), the binary solid mixture of pure components A and B is further cooling.

We close this section on the liquid-solid-phase behavior of binary systems by showing some typical phase diagrams: if both components form a mixed crystal in the solid phase, the isobaric melting phase diagram looks identical to the isobaric boiling phase diagram. The formal treatment via the chemical equilibrium then is exactly identical, replacing boiling temperatures and boiling enthalpies with freezing temperatures and freezing enthalpies, respectively.



In the past four years we have drilled

81,000 km

That's more than **twice** around the world.

Who are we?
We are the world's leading oilfield services company. Working globally—often in remote and challenging locations—we invent, design, engineer, manufacture, apply, and maintain technology to help customers find and produce oil and gas safely.

Who are we looking for?
We offer countless opportunities in the following domains:

- Engineering, Research, and Operations
- Geoscience and Petrotechnical
- Commercial and Business

If you are a self-motivated graduate looking for a dynamic career, apply to join our team.

What will you be?

Schlumberger

careers.slb.com

Click on the ad to read more

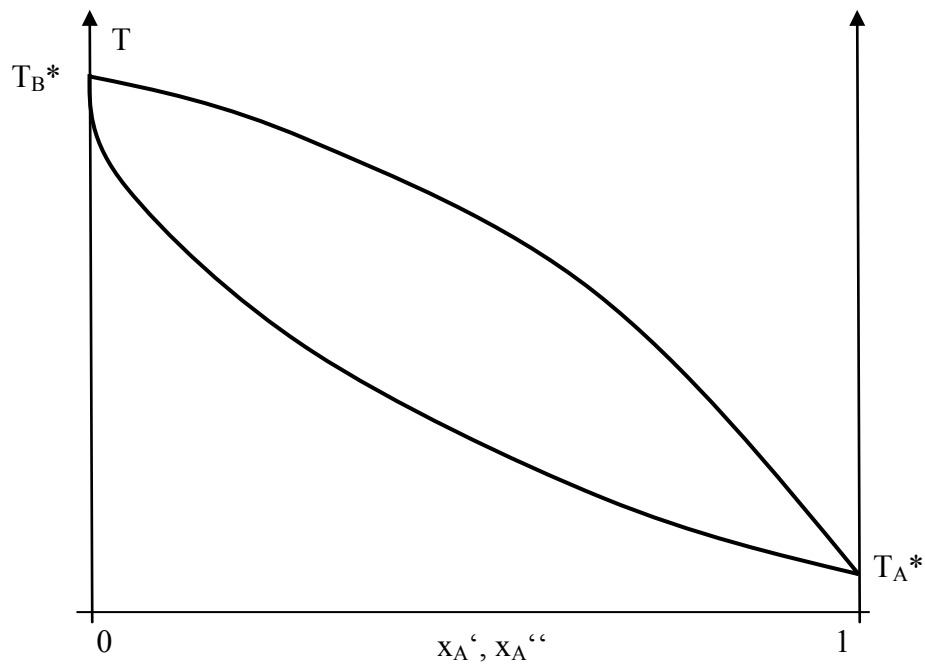

Figure 2.28: Experimental isobar melt diagram of an ideal binary mixture (e.g. Ge/Si)

On the other hand, if the two components are only partially miscible in the solid phase, various different types of phase diagrams are found, as shown in figure 2.29:

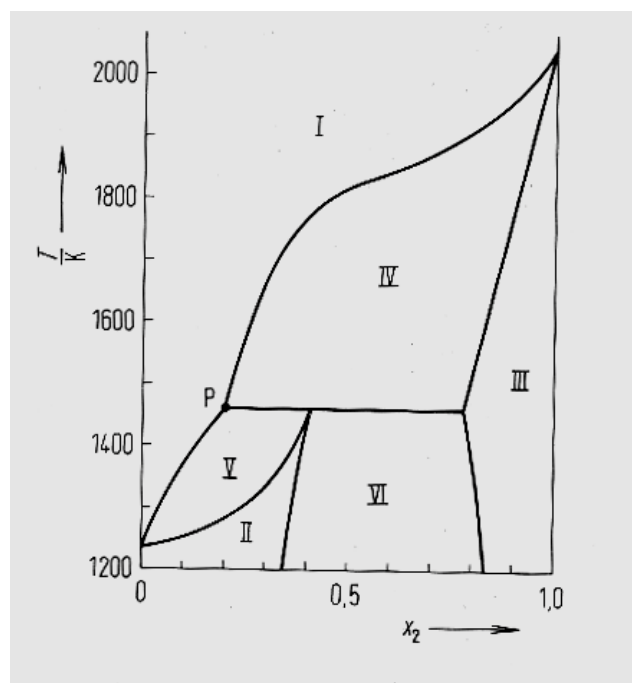

Figure 2.29: Experimental isobar melt diagram of Ag/Pt (from: Gerd Wedler und Hans-Joachim Freund, *Lehrbuch der Physikalische Chemie*, p.396, 6.Auflage, Weinheim 2012. Copyright Wiley-VCH Verlag GmbH & Co. KGaA. Reproduced with permission.)

2.5.5 Colligative phenomena

In this section on colligative phenomena, we will first combine the effects of increase in boiling temperature and decrease in freezing temperature by discussing the chemical potential in dependence of temperature for pure liquids and dilute solutions, respectively.

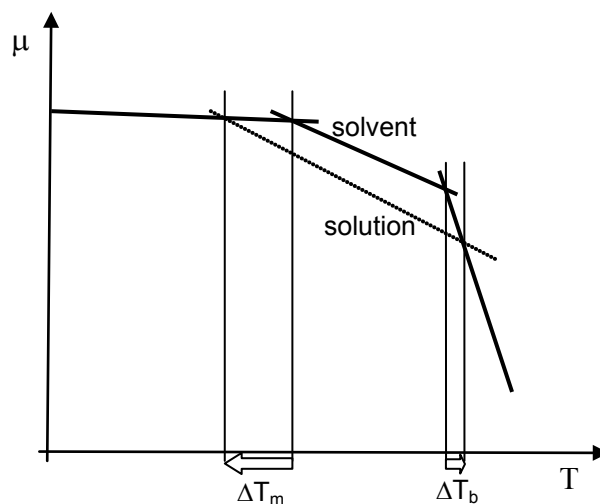

Fig. 2.30: The temperature-dependence of the chemical potential of a pure solvent and of a dilute solution, explaining the colligative phenomena of “decrease in melting temperature” and “increase in boiling temperature”

If we regard colligative phenomena, both the solid and the vapor phase are no mixtures in the thermodynamic sense, and therefore the chemical potential of the pure solvent and the dilute solution only differ at the liquid state by the term $RT \cdot \ln x_A$. Therefore, the liquid line is shifted to lower chemical potential for the liquid solution.

Note that the slope $d\mu/dT$ is given by the entropy of the respective phase, since $dG = -SdT + Vdp$. The disorder increases from solid to vapor, and consequently the slope becomes steeper from left to right. This explains the colligative phenomena also in a simple graphical way: for the solution, the intersections with the solid line and the vapor line are, in respect to the pure solvent, shifted to the left and right, respectively. Further, this shift has to be more pronounced for the melting transition, explaining why you often find an experiment about freezing point suppression in the basic practical course physical chemistry, but rarely an experiment about the increase of the boiling temperature: the latter effect is simply too small for dilute solutions to be measured in a practical course.

Example 2.5:

Consider two aqueous solutions containing 1 wt% of salt (NaCl) or sugar (saccharose), respectively, and calculate the boiling and melting temperatures using the approximation for very dilute solutions. The cryoscopic constant of water is $K_c = 1.86 \text{ K} \cdot \text{kg}/\text{mole}$, the ebullioscopic constant is $K_e = 0.521 \text{ K} \cdot \text{kg}/\text{mole}$.

Solution: the respective colligative phenomena are given as

$\Delta T = K_x \cdot \frac{n}{m_s}$, with m_s the mass of the solvent water (= 1 kg), and n the molar amount of dissolved particles. With the molar masses of salt ($M(\text{NaCl}) = 58.5 \text{ g}/\text{Mol}$, note that 2 ions are formed per NaCl upon dissolution in water) and sugar ($M(\text{saccharose}) = 342.3 \text{ g}/\text{mole}$), we calculate the following:

decrease in melting temperatures (compared to $T = 0 \text{ }^\circ\text{C}$):

$$\Delta T = 1.86 \cdot \frac{2 \cdot \frac{10}{58.5}}{1} = -0.636 \text{ K for salt,} \quad \Delta T = 1.86 \cdot \frac{\frac{10}{342.3}}{1} = -0.054 \text{ K for sugar,}$$

increase in boiling temperatures (compared to $T = 100 \text{ }^\circ\text{C}$):

$$\Delta T = 0.521 \cdot \frac{2 \cdot \frac{10}{58.5}}{1} = +0.178 \text{ K for salt,} \quad \Delta T = 0.521 \cdot \frac{\frac{10}{342.3}}{1} = +0.015 \text{ K for sugar.}$$

Note that the effects are much stronger for the salt solution, and also that the change in melting temperature is nearly 4 times stronger than the change in boiling temperature. Typically, the freezing temperature decrease is much larger than the boiling temperature increase, which is one explanation why typically only freezing point suppression is quantitatively investigated in a Physical-Chemical lab course.

Finally, we are still missing one last colligative phenomenon, which also is the most pronounced and therefore the most suitable for experimental practice, i.e. accurate measurement of the solute molar fraction: the osmotic pressure.

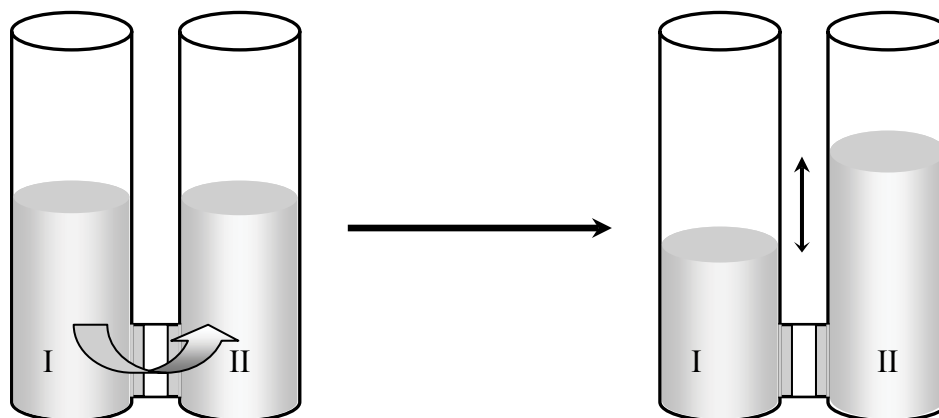

Fig. 2.31: Osmosis, pure solvent in the left chamber (I), dilute solution in the right chamber (II)

As sketched in figure 2.31, at the beginning of our experiment solvent and dilute solution are separated by a semipermeable membrane, which only allows permeation of the small solvent molecules. Also, both liquid phases shall have the same hydrostatic pressure. To reach equilibrium, the system tries to equilibrate to solute concentration in both cylinders, which can only be achieved by migration of solvent from left to right through the membrane. This, however, causes an increase of the hydrostatic pressure in the cylinder containing the solute, and a corresponding decrease in pressure in the cylinder with the pure solvent. Finally, the system reaches chemical equilibrium at a defined pressure difference π which depends on the actual solute concentration.



Hellmann's is one of Unilever's oldest brands having been popular for over 100 years. If you too share a passion for discovery and innovation we will give you the tools and opportunities to provide you with a challenging career. Are you a great scientist who would like to be at the forefront of scientific innovations and developments? Then you will enjoy a career within Unilever Research & Development. For challenging job opportunities, please visit www.unilever.com/rjjobs.

Could it be  Unilever



Note that, in experimental practice, the amount of solvent flowing through the membrane should be negligibly small in comparison to the overall amount of solvent in the solution in the right chamber. Otherwise, the starting concentration of the solute would change due to dilution with the inflowing solvent, and one would have to recalculate the solute concentration in the right chamber at stationary conditions accordingly. In experimental practice, one is therefore often using bulky chambers with very thin necks, so the pressure difference is only created by a small amount of inflowing solvent. More sophisticated, one can also measure an external force per area needed to completely suppress any solvent flow from left to right if solution and solvent are otherwise kept at identical pressure. In this case, the osmotic pressure is compensated by this external force.

Formally, the osmotic equilibrium is treated as following:

$$\mu_A(x_A = 1, p) = \mu_A^*(p) = \mu_A(x_A < 1, p + \pi) \quad (\text{Eq.2.135})$$

This means that the chemical potential of the pure solvent at lower pressure is identical to the chemical potential of the solvent in a solution at higher pressure $p + \pi$. Explicitly inserting the dependence of chemical potential on molar fraction of the solvent ($\mu_A(x_A < 1, p + \pi) = \mu_A^*(p + \pi) + RT \cdot \ln x_A$) and pressure ($\left(\frac{\partial \mu_A^*}{\partial p}\right)_T = \left(\frac{\partial G_{A,mol}}{\partial p}\right)_T = V_{A,mol} dp \Rightarrow \mu_A^*(p + \pi) = \mu_A^*(p) + \int_p^{p+\pi} V_{A,mol} dp$), respectively, we finally get:

$$\mu_A(x_A < 1, p + \pi) = \mu_A^*(p) + \int_p^{p+\pi} V_{A,mol} dp + RT \cdot \ln x_A \quad (\text{Eq.2.136})$$

Or, for the equilibrium between pure solvent and solution:

$$RT \cdot \ln x_A = - \int_p^{p+\pi} V_{A,mol} dp \quad (\text{Eq.2.137})$$

For dilute solutions we again use the Taylor series expansion to replace the logarithm simply with the molar fraction of the solute x_B . Also, the molar volume of the liquid phase $V_{A,mol}$ is nearly independent of pressure, and this leads to a fairly simple expression:

$$\pi V_{A,mol} = RT \cdot x_B \quad (\text{Eq.2.138})$$

Considering that

$$x_B = \frac{n_B}{n_A + n_B} \approx \frac{n_B}{n_A} \quad (\text{Eq.2.139})$$

we end up with an expression similar to the ideal gas equation, namely:

$$\pi V = n_B \cdot RT \quad (\text{Eq.2.140})$$

called the van't Hoff equation of osmotic pressure.

For illustration of the osmotic effect and its practical relevance, consider the following problem:

Example 2.6:

Compare the minimum amount of energy needed to prepare 1 m³ (= 1 ton) of drinking water from sea water via (i) simple boiling, and (ii) reversed osmosis (= squeezing sea water through a membrane to remove the salt). The salt (mainly: NaCl) content of sea water is 3.5 wt%, the molar evaporation heat of water is $\Delta H_{V,mol} = 40.66 \cdot \frac{kJ}{mol}$

Solution:

(i) For simply boiling the water and collecting the pure water vapor, you need at least the energy amount:

$$Q = n \cdot \Delta H_{V,mol} = \frac{1e6 \text{ g}}{18 \text{ g/mol}} \cdot 40.66 \cdot \frac{kJ}{mol} = 2.26e9 \text{ kJ}$$

(ii) For osmosis, the minimum amount of energy corresponds to the reversible work ΔG , which is given by the difference in chemical potentials of pure water and sea water, respectively:

$$\Delta G = n \cdot (\mu_A^* - \mu_A) = \frac{1e6 \text{ g}}{18 \text{ g/mol}} \cdot RT \cdot \ln x_A$$

The molar fraction of water in sea water is given as:

$$x_A = \frac{n_{H_2O}}{n_{H_2O} + 2 \cdot n_{NaCl}} = \frac{1000/18}{1000/18 + 2 \cdot 35/(58.5)}$$

Inserting this in the equation for ΔG , we finally get for the minimum energy amount needed for removing the salt from 1 ton of sea water by so-called reversed osmosis:

$$\Delta G = W_{rev} = 2.99e6 \text{ kJ} = 0.83 \text{ kWh}$$

In the internet, you find that in technical practice about 1.5 – 2 kWh of energy is needed to prepare 1 ton of drinking water by reversed osmosis, which is about twice the amount needed for the reversible process (= 50% efficiency!). Note that still, in terms of energy consumption, reversed osmosis is about 500 times more efficient (and economical) than simple boiling!

Even if the energy to achieve the pressure needed to squeeze the sea water through the membrane is obtained via photovoltaics, a solar cell of efficiency of only 10% still leads to an overall energy consumption efficiency osmosis : boiling = 50 : 1 !!!

Summary of colligative phenomena for thermodynamically ideal dilute solutions (only the entropy of mixing is considered (athermal mixtures!)):

(i) vapor pressure suppression:

For a dilute solution, the vapor pressure is lower than that of the pure solvent, as described by the law of Raoult:

$$p = x'_A \cdot p_A^*$$

(ii) boiling temperature increase:

A dilute solution shows a higher boiling temperature than the pure solvent. This effect depends only on molar solute concentration and the solvent properties expressed by the ebullioscopic constant:

$$\Delta T = \frac{R \cdot T_A^{*2} \cdot M_A}{\Delta_V H_A} \cdot \frac{m'_B}{M_B} \cdot \frac{1}{m_A}$$

(iii) melting temperature decrease:

A dilute solution shows a lower melting temperature than the pure solvent. This effect depends only on molar solute concentration and the solvent properties expressed by the cryoscopic constant:

$$\Delta T = \frac{R \cdot T_A^{*2} \cdot M_A}{\Delta_S H_A} \cdot \frac{m'_B}{M_B} \cdot \frac{1}{m_A}$$

(iv) osmotic pressure:

The osmotic pressure of a dilute solution is given by the van't Hoff equation:

$$\pi V = n_B \cdot RT$$

All these phenomena are, in principle, useful to “count the number of dissolved particles”. Note that osmotic pressure is the most sensitive, but restricted to comparatively large solute particles which are unable to pass the membrane.

We conclude this section on phase equilibrium of two-component systems with a simple thermodynamic model of saturated solutions, neglecting contributions by solvation enthalpy, i.e. $\Delta H_{mix} = 0$:

We can treat this equilibrium exactly the same way as the lowering of the freezing temperature in solutions, but this time the solute B is found in the pure solid phase, therefore:

$$\frac{\Delta_S H_B}{R} \left(-\frac{1}{T} + \frac{1}{T_B^*} \right) = \ln x'_B \quad (\text{Eq.2.141})$$

Here, the solubility parameter $\Delta_S H_B / (RT_B^*)$, with $\Delta_S H_B$ the melting enthalpy and T_B^* the melting temperature of the pure solute B, defines the solubility of a given component B. Note that the solubility of B for our ideal mixture reaches 100% at the melting temperature, i.e. we have a pure liquid of B in this case. At lower temperature, the solubility continuously decreases, reaching 0 at $T = 0$ K. Also, the solubility at given reduced temperature T/T_B^* is larger the smaller our solubility parameter.

2.6 The chemical equilibrium

If we consider a spontaneous chemical reaction at constant pressure and temperature, it takes place, like any spontaneous process, only if the change in Gibbs free enthalpy $\Delta G < 0$! Considering the Gibbs-Helmholtz-equation $\Delta G = \Delta H - T\Delta S$, there are different possibilities for such so-called exergonic spontaneous reactions: the best case is a reaction releasing heat to the environment and creating disordered products, like for example burning of fuel: here, both the entropy of the reactants and of the environment are increasing, which is very favorable according to the 2nd principle of thermodynamics.

Another possibility is an exothermic process, i.e. heat release from the system to the environment, while forming ordered products. If the overall change in entropy is still positive, i.e. $\Delta S_{tot} = \Delta H/T - \Delta S > 0$, this process may also be spontaneous, e.g. crystallization of a solute from a saturated solution. Similarly, an endothermic process is possible if the increase in disorder compensated the loss in entropy of the environment due to the heat transfer, i.e. $\Delta S_{tot} = \Delta S - \Delta H/T > 0$. A simple example of this type of process is the dissolution of salt in water, often leading to a decrease in temperature (endothermic process).

Finally, there is no possibility of a spontaneous endergonic process with 100% conversion (conversion = molar percentage of products formed from the original chemicals (educts), 100% conversion therefore means the reaction is complete!), i.e. endothermic and creating ordered products at the same time. The four different combinations of reaction enthalpy and reaction entropy are summarized in the table (tab.2.1.):

change in enthalpy	change in entropy	spontaneous reaction ?
exotherm ($\Delta H < 0$)	$\Delta S > 0$	yes, $\Delta G < 0$
exotherm ($\Delta H < 0$)	$\Delta S < 0$	yes, if $ T \cdot \Delta S < \Delta H $
endotherm ($\Delta H > 0$)	$\Delta S > 0$	yes, if $T \cdot \Delta S > \Delta H$
endotherm ($\Delta H > 0$)	$\Delta S < 0$	no, $\Delta G > 0$

Table.2.1: Conditions for spontaneous (exergonic) chemical reactions

If the conversion is smaller than 100%, however, and a mixed phase of starting materials and products is formed at the chemical equilibrium, also an endergonic process may take place, at least up to a conversion rate of 50%. Thermodynamically, this is based on the fact that, in addition to the free enthalpies of the pure products and educts, we also have to consider now contributions from the free enthalpy of mixing.

Figure 2.32. illustrates the total free enthalpy of our reaction system versus conversion ξ in case of an endergonic process (free enthalpy of the products is larger than that of the educts), and for a process with $\Delta G = 0$. Note that the stable state, i.e. the minimum in free enthalpy, is reached at a conversion of 0.5 (or 50%) for the latter case, since here the minimum in free enthalpy of mixing (or maximum in entropy of mixing) is the driving force for the process. On the other hand, an endergonic process still may proceed until the mixing free enthalpy exactly compensates the corresponding reaction free enthalpy, that is, to conversions between 0 and 0.5.

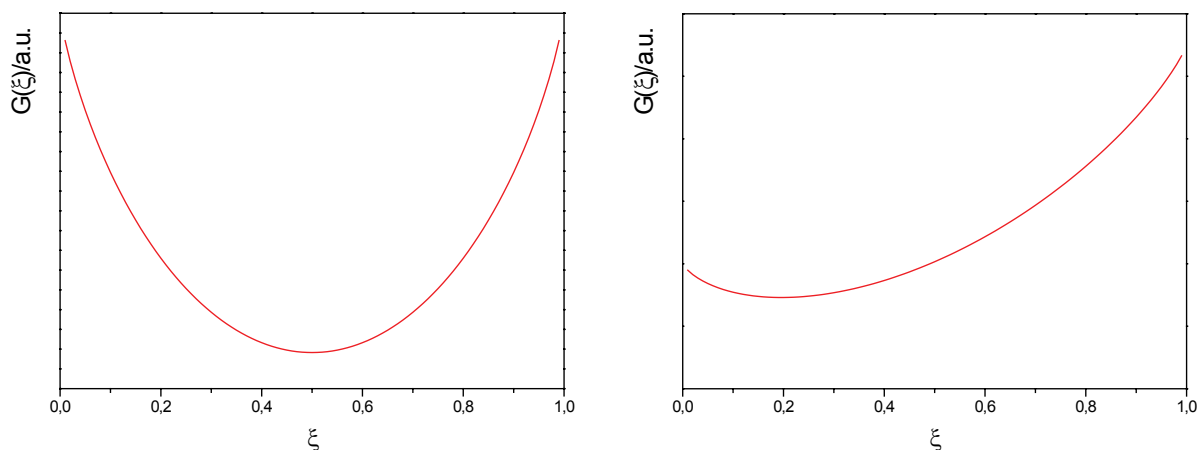

Fig. 2.32: Reaction free enthalpy versus conversion and the chemical equilibrium

Mathematically, we can treat the chemical equilibrium exactly in the same way as the phase equilibria. Let us consider the following reversible chemical reaction:



This reaction reaches its equilibrium conversion if the chemical potentials of educts and products are identical, or:

$$\mu_A + \mu_B = \mu_C + \mu_D \quad (\text{Eq.2.143})$$

If the equilibrium state is a homogeneous reaction mixture of all components, we get:

$$\mu_A^* + RT \cdot \ln x_A + \mu_B^* + RT \cdot \ln x_B = \mu_C^* + RT \cdot \ln x_C + \mu_D^* + RT \cdot \ln x_D \quad (\text{Eq.2.144})$$

Or

$$\begin{aligned} -RT \cdot \ln x_C - RT \cdot \ln x_D + RT \cdot \ln x_A + RT \cdot \ln x_B &= \mu_C^* + \mu_D^* - \mu_A^* - \mu_B^* \\ -RT \cdot \ln \frac{x_C \cdot x_D}{x_A \cdot x_B} &= -RT \cdot \ln K_x = \Delta_R G^* \end{aligned} \quad (\text{Eq.2.145})$$

With K_x the constant of chemical equilibrium, which, according to the last equation, depends on reaction temperature and the difference in free enthalpy of pure products and pure educts $\Delta_R G^*$. For neither exergonic nor endergonic reactions, i.e. $\Delta_R G^* = 0$, we obtain $K_x = 1$, which, as we have already discussed, corresponds to a conversion $\xi = 0.5$. For exergonic reactions $\Delta_R G^* < 0$, $K_x > 1$, and the conversion at equilibrium is larger than 50%.

Let us conclude this chapter about the chemical equilibrium with a brief visit of the famous principle of Le-Chatelier: the equilibrium of a chemical process reacts on the change of an external parameter like temperature or pressure such as to minimize the change. Simply spoken, if we consider an exothermic chemical reaction and increase the reaction temperature, the endothermic back reaction is favored to compensate, leading to a shift of the chemical equilibrium towards smaller conversion. Formally, this is fairly simple to understand if we discuss the above equation in a little more detail:

$$-RT \cdot \ln K_x = \Delta_R G^* = \Delta_R H^* - T\Delta_R S^* \quad (\text{Eq.2.146})$$

$$\ln K_x = -\frac{\Delta_R H^*}{RT} + \frac{\Delta_R S^*}{R} \quad (\text{Eq.2.147})$$

$$\frac{d \ln K_x}{dT} = \frac{\Delta_R H^*}{RT^2} \quad (\text{Eq.2.148})$$

If the process is exothermic, i.e. $\Delta_R H^* < 0$, K_x therefore has to decrease with increasing temperature.



Discover the truth at www.deloitte.ca/careers

Deloitte.

© Deloitte & Touche LLP and affiliated entities.



Click on the ad to read more

Another example of the principle of Le-Chatelier is the pressure dependence of the Haber-Bosch-reaction, the formation of NH_3 from the elements H_2 and N_2 (see Eq.(2.149)). Since formally this reaction leads from five gas molecules to two, an increase in pressure favors the process.



Example 2.7:

Consider a simple chemical equilibrium of type $A \rightleftharpoons B$. Calculate the relative change in conversion of A to B, if the reaction temperature is increased from $T = 25^\circ\text{C}$ to $T = 100^\circ\text{C}$, and the reaction enthalpy $\Delta_R H = -80 \text{ kJ/Mol}$.

Solution: the variation of the chemical equilibrium constant, which provides a measure for the conversion, with temperature is given as

$$\frac{d \ln K_x}{dT} = \frac{\Delta_R H}{RT^2} \quad , \quad \text{or} \quad \ln K_x(T_2) - \ln K_x(T_1) = \ln \frac{K_x(T_2)}{K_x(T_1)} = \frac{\Delta_R H}{R} \cdot \left(\frac{1}{T_1} - \frac{1}{T_2} \right)$$

$$\frac{K_x(T_2)}{K_x(T_1)} = \exp \frac{\Delta_R H}{R} \cdot \left(\frac{1}{T_1} - \frac{1}{T_2} \right) = \exp \left[\frac{-80000}{8.314} \cdot \left(\frac{1}{298} - \frac{1}{373} \right) \right] = 0.00151$$

This means, for example, that if at room temperature we have a conversion A to B of 50 % ($K_x = 1$), at $T = 100^\circ\text{C}$ the conversion is only about 0.15 % ($K_x = x_A/x_B \approx 0.00151/1$). Our result is also a confirmation of the principle of Le-Chatelier: if you increase the reaction temperature for our strongly exothermic chemical reaction, the equilibrium is shifted in favor of the endothermic backreaction.

As an additional exercise (not typical for Physical-Chemical problems, but related to general chemical calculus), let us determine the exact conversion corresponding to $K_x = 0.00151$:

$$K_x = \frac{x_A}{x_B} = \frac{x}{1-x} = 0.00151 \quad \Rightarrow \quad x = \frac{0.00151}{1+0.00151} = 0.001508$$

The result proves our approximation $x_B \approx 1$ to be acceptable in this case.

2.7 Reaction energy

As we have learned in the last chapter, the temperature dependence of the chemical equilibrium depends on the reaction enthalpy. To measure this reaction enthalpy, one can simply determine the change in temperature if the reaction is carried out at isobar conditions and 100% conversion, i.e. $\Delta_R H^* = c_p \cdot \Delta T$. However, if it is not possible to monitor the reaction itself directly, one can apply the principle of Hess, which is based on the fact that the reaction enthalpy or the reaction energy both are quantities of state, that are independent of the process itself. Consider, for illustration, the reaction enthalpy of the hydration of ethylene to ethane. Instead of observing this process, one could measure the heat of burning of ethylene and hydrogen as the educts, or pure ethane as the product, respectively, with pure oxygen (see fig. 2.33):

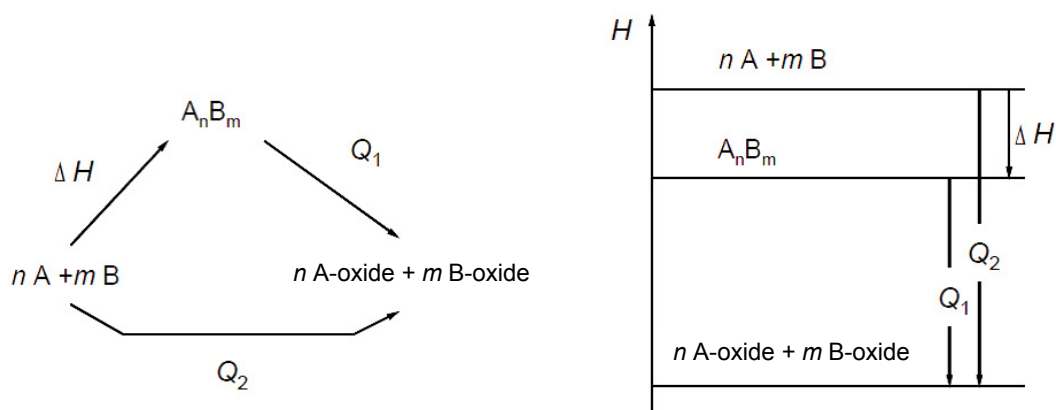

Fig. 2.33: The principle of Hess – conservation of energy/enthalpy for chemical reactions irrespective of the reaction pathway

The hydration enthalpy is then simply the difference between the two heats of burning $\Delta H = Q_1 - Q_2$. Note that in this way any reaction energy or enthalpy can be determined, taking into account also that the enthalpy of a pure element in its stable modification at standard conditions ($T = 298 \text{ K}$, $p = 1 \text{ bar}$) is defined as zero. For illustration, consider the burning of hydrogen with oxygen to water at standard conditions $H_2 + \frac{1}{2} O_2 \rightarrow H_2O$. The heat of burning in this case is directly the reaction enthalpy $\Delta_R H^* = H_{H_2O} - H_{H_2} - \frac{1}{2} H_{O_2}$.

According to the convention, we can also write $\Delta_R H^* = H_{H_2O}$. In this way, one can determine, based on some simple model reactions, a whole set of reaction enthalpies mainly on calculations. More importantly, one can also determine the enthalpy of individual chemical groups like CH_2 or $COOH$, leading to the total enthalpy of more complicated organic molecules without the necessity of more experiments.

To complete this puzzle, we need to know how to transfer our reaction enthalpy from standard temperature to any reaction temperature. Again, we utilize the fact that the enthalpy is a quantity of state irrespective of the process itself. Consider two possibilities for the reaction from $A(T)$ to $B(T+\Delta T)$: either you can first heat the educt A and then carry out the reaction at temperature $T+\Delta T$, or you can carry out the reaction first at T and then change the temperature of the product to $T+\Delta T$. Either way, the overall change in enthalpy should be the same. This leads us to the important Kirchhoff law:

$$\sum c_p(A) \cdot \Delta T + \Delta_R H_{T+\Delta T} = \Delta_R H_T + \sum c_p(E) \cdot \Delta T \quad (\text{Eq.2.150})$$

$$\Delta_R H_{T+\Delta T} - \Delta_R H_T = (\sum c_p(E) - \sum c_p(A)) \cdot \Delta T \quad (\text{Eq.2.151})$$

$$d(\Delta_R H) = (\sum c_p(E) - \sum c_p(A)) \cdot dT \quad (\text{Eq.2.152})$$

$$\left(\frac{\partial(\Delta_R H)}{\partial T}\right) = \sum c_p(E) - \sum c_p(A) \quad (\text{Eq.2.153})$$

$$\left(\frac{\partial(\Delta_R H)}{\partial T}\right) = \sum \nu_i c_{pi} \quad (\text{Eq.2.154})$$

That is, the change in reaction enthalpy with temperature is simply given by the difference in isobar heat capacities of products and educts.

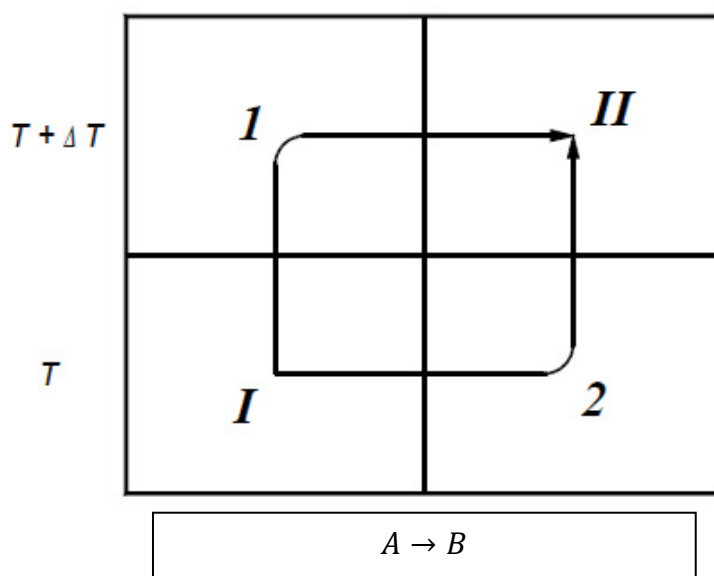

Fig. 2.34: Kirchhoff law, two different routes from educt $A(T)$ to product $B(T+\Delta T)$ with identical overall reaction enthalpy

3 Kinetics

The velocity of a chemical reaction is defined as the change in concentration (for gas reactions: partial pressure) with time, taking into account the stoichiometric coefficients of the respective components. In experimental practice, this concentration can be quantified in various ways, for example: photometry (measurement of absorbed light at specific wave length following the law of Lambert-Beer), conductometry (measurement of electric conductance, in case either ions are formed or consumed during the chemical reaction), or polarimetry (measurement of the rotational angle of polarized light in case optically active components are involved).

In the simple case of elementary reactions, that is, reactions with one single reaction step from educt to product (involving an excited state, see also figure 3.3 at the end of this chapter!), the decrease in concentration of component A with time for the reaction



is given as:

$$-\frac{dc_A}{dt} = k \cdot c_A^{n_A} \cdot c_B^{n_B} \quad (\text{Eq.3.2})$$

More general, the reaction velocity for this reaction is given as:

$$v = -\frac{1}{n_A} \frac{dc_A}{dt} = -\frac{1}{n_B} \frac{dc_B}{dt} = \frac{1}{n_C} \frac{dc_C}{dt} \quad (\text{Eq.3.3})$$

The velocity constant k is dependent on temperature, and may be increased by adding a catalyst, as we will see when we introduce the Arrhenius equation below. The total order of the reaction is given by the sum of all stoichiometric coefficients of the educts, i.e. $n = n_A + n_B$. Here, it should be stressed again that this reaction order is only identical with the molecularity of the reaction, i.e. the total number of molecules reacting, if the whole process consists of a single reaction step!

Importantly, for more complex reactions which usually consist of multiple reaction steps, one has to distinguish clearly between the order of the reaction and the molecularity of the individual reaction steps: the order corresponds to a macroscopic experimental quantity, namely the exponent with which the reactions velocity scales with the respective concentration (see Eq.3.3). On the other hand, the molecularity of a single reaction step corresponds to the microscopic mechanism of this reaction step. As a consequence, a chemical reaction which is experimentally found to be of 2nd order must not necessarily be a bimolecular reaction, since a combination of several reaction steps of different molecularities can lead to an overall reaction order of 2. Actually, a variety of possible combinations of elementary reaction steps (= proposed mechanisms of a chemical reaction) may lead to the same experimental result concerning the order of a chemical reaction!

In the first section of this chapter about chemical kinetics, we will mathematically treat the kinetics of the simplest case possible, elementary reactions with only a single educt species (section 3.1.1), or bimolecular reactions with two different educt species A, B (section 3.1.2).

Grant Thornton—^{REALLY} a great place to work.

We're proud to have been recognized as one of Canada's Best Workplaces by the Great Place to Work Institute™ for the last four years. In 2011 Grant Thornton LLP was ranked as the fifth Best Workplace in Canada, for companies with more than 1,000 employees. We are also very proud to be recognized as one of Canada's top 25 Best Workplaces for Women and as one of Canada's Top Campus Employers.



Priyanka Sawant
Manager



Audit • Tax • Advisory
www.GrantThornton.ca/Careers



Grant Thornton
An instinct for growth™

© Grant Thornton LLP. A Canadian Member of Grant Thornton International Ltd



Click on the ad to read more

3.1 Elementary reactions (one single reaction step, molecularity = order)

3.1.1 Elementary reactions of type $A \rightarrow B$

In case of a single educt A, the differential equations can easily be resolved. Here, we distinguish reactions of orders 0 to 3:

Order 0: Note that this is no elementary reaction in the strict sense, since the actual reaction mechanism is a two-step process, 1st step the combination of educt and a catalyst, and 2nd step the formation of the product which is released from the catalyst:



In case of high concentrations of the educt, the catalyst is completely covered, and the reaction velocity therefore is constant:

$$-\frac{dc_A}{dt} = k \quad (\text{Eq.3.4})$$

$$dc_A = -kdt \quad (\text{Eq.3.5})$$

$$\int_{c_{A,0}}^{c_A(t)} dc_A = \int_0^t -kdt \quad (\text{Eq.3.6})$$

$$c_A(t) = c_{A,0} - k \cdot t \quad (\text{Eq.3.7})$$

i.e., the concentration decreases linearly with reaction time.

Order 1: A typical example of unimolecular elementary reactions are radioactive decay processes. The reaction velocity here is proportional to the actual educt concentration, and therefore decreases with time as:

$$-\frac{dc_A}{dt} = k \cdot c_A \quad (\text{Eq.3.8})$$

$$\frac{dc_A}{c_A} = -kdt \quad (\text{Eq.3.9})$$

$$\int_{c_{A,0}}^{c_A(t)} \frac{dc_A}{c_A} = \int_0^t -kdt \quad (\text{Eq.3.10})$$

$$\ln c_A(t) - \ln c_{A,0} = -k \cdot t \quad (\text{Eq.3.11})$$

$$c_A(t) = c_{A,0} \cdot \exp(-k \cdot t) \quad (\text{Eq.3.12})$$

The educt concentration decreases exponentially with time.

Order 2: Examples are any bimolecular homologous reactions, for example $NO + NO \rightarrow N_2O_2$. The reaction velocity in this case scales with the educt concentration squared:

$$-\frac{dc_A}{dt} = k \cdot c_A^2 \quad (\text{Eq.3.13})$$

$$\frac{dc_A}{c_A^2} = -k dt \quad (\text{Eq.3.14})$$

$$\int_{c_{A,0}}^{c_A(t)} \frac{dc_A}{c_A^2} = \int_0^t -k dt \quad (\text{Eq.3.15})$$

$$-\frac{1}{c_A(t)} + \frac{1}{c_{A,0}} = -k \cdot t \quad (\text{Eq.3.16})$$

The educt concentration varies hyperbolically with time.

Order 3: Because they afford the simultaneous collision and reaction of three molecules, elementary reactions of this type are highly improbable. Nevertheless, we will treat this elementary reaction as an additional exercise how to solve simple differential equations. The reaction velocity scales with the educt concentration cubed:

$$-\frac{dc_A}{dt} = k \cdot c_A^3 \quad (\text{Eq.3.17})$$

$$\frac{dc_A}{c_A^3} = -k dt \quad (\text{Eq.3.18})$$

$$\int_{c_{A,0}}^{c_A(t)} \frac{dc_A}{c_A^3} = \int_0^t -k dt \quad (\text{Eq.3.19})$$

$$-\frac{1}{2 \cdot c_A(t)^2} + \frac{1}{2 \cdot c_{A,0}^2} = -k \cdot t \quad (\text{Eq.3.20})$$

To compare the conversion curves for these different elementary reactions of reaction orders 0, 1, 2 and 3, we consider identical starting concentrations $c_{A,0} = 1 \text{ mol/L}$ and identical magnitudes of the velocity constant $k = 1$ (in respective units). For 0 order, this means $k = 1 \text{ mol/(L} \cdot \text{s)}$, for 1st order $k = 1/\text{s}$, for 2nd order $k = 1 \text{ L/(mol} \cdot \text{s)}$, and for 3rd order $k = 1 \text{ L}^2/(\text{mol}^2 \cdot \text{s)}$. In this case, the initial reaction velocities should all be equal to $-\frac{dc_A}{dt} = 1 \text{ mol/(L} \cdot \text{s)}$, and the velocity (or decaying slope) decreases with time for reactions of order >0 , with the curvature more pronounced the higher the reaction order.

Note that, for reactions of 1st order, we can define a half-conversion-time, i.e. the reaction time it takes until 50% of the educt amount is consumed:

$$t_{1/2} = \frac{\ln 2}{k} \quad (\text{Eq.3.21})$$

All 4 conversion curves are compared in figure 3.1, including an indication of $t_{1/2}$ for the reaction of 1st order:

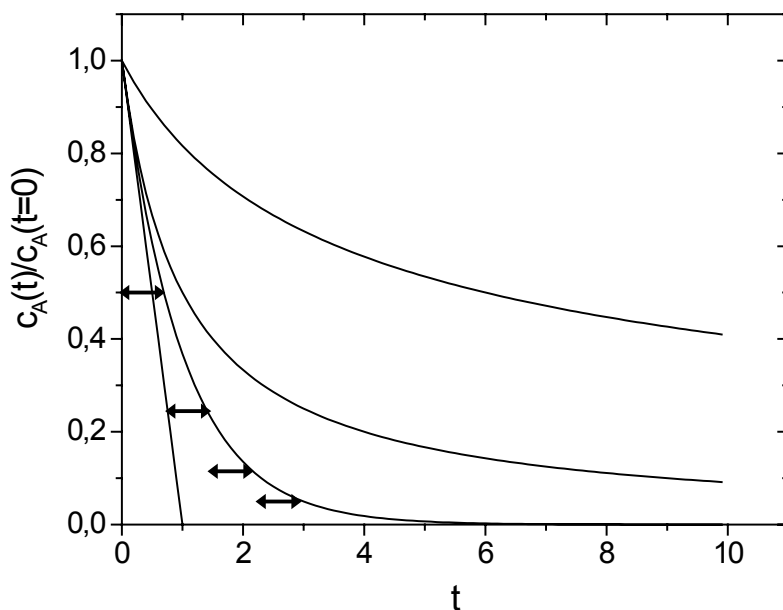

Figure 3.1: Time-evolution of the normalized educt concentration for elementary reactions of orders 0, 1, 2 and 3 (from left (= linear decay) to right), including $t_{1/2}$ for the reaction of 1st order as arrows.

The Wake

the only emission we want to leave behind

Low-speed Engines Medium-speed Engines Turbochargers Propellers Propulsion Packages PrimeServ

The design of eco-friendly marine power and propulsion solutions is crucial for MAN Diesel & Turbo. Power competencies are offered with the world's largest engine programme – having outputs spanning from 450 to 87,220 kW per engine. Get up front! Find out more at www.mandieselturbo.com

Engineering the Future – since 1758.

MAN Diesel & Turbo

Click on the ad to read more

Note here that $t_{1/2}$ does not make sense for elementary reactions of orders other than 1, which can easily be seen from a simple numerical example: for instance, if a reaction of order 0 takes 30 minutes for the conversion of 50% of the original amount of the educt, it will take only 15 minutes to reach 25%. On the other hand, if a reaction of 2nd order takes 30 minutes for the conversion of the first 50% of educt, 25% will be reached after another 60 minutes.

Example 3.1:

Consider a radioactive material with halftime 30 years. After how much time has the radiation level decayed to below 1% of its initial value?

Solution: We use the following equations for an elementary reaction of 1st order:

$$c_A(t) = c_A(t=0) \cdot \exp[-k \cdot t], \quad \text{and} \quad k = \frac{\ln 2}{t_{1/2}}.$$

Therefore, $k = \frac{\ln 2}{t_{1/2}} = \frac{\ln 2}{30 \text{ y}} = 0.0231 \text{ y}^{-1}$. With

$$\frac{c_A(t)}{c_A(t=0)} = \frac{1}{100} = \exp[-0.0231 \text{ y}^{-1} \cdot t] \quad \text{we finally get}$$

$$t = \frac{\ln 0.01}{-0.0231 \text{ y}^{-1}} = 199.4 \text{ y}.$$

It will take about 200 years or several generations until the radiation level is below 1%!

3.1.2 Elementary bimolecular (and 2nd order!) reactions of type $A + B \rightarrow C$

Many elementary reactions of 2nd order comprise two different types of educts A, B. In this case, the general solution of the differential equation is not any longer trivial, as in case of single component elementary reactions. For an elementary 2nd order reaction of type $A + B \rightarrow C$ the velocity is given as:

$$-\frac{dc_A}{dt} = \frac{dc_C}{dt} = k \cdot c_A \cdot c_B \quad (\text{Eq.3.22})$$

To solve this equation, which contains three variables at this stage, we express the actual educt concentrations via their respective starting concentrations minus the concentration of product already formed, i.e.:

$$\frac{dc_C}{dt} = k \cdot (c_{A,0} - c_C) \cdot (c_{B,0} - c_C) \quad (\text{Eq.3.23})$$

or

$$\frac{dc_C}{(c_{A,0} - c_C)(c_{B,0} - c_C)} = k \cdot dt \quad (\text{Eq.3.24})$$

This seemingly complicated differential equation can easily be solved via so-called partial fraction integration. First, we split the left side of the equation as:

$$\frac{dc_C}{(c_{A,0}-c_C)(c_{B,0}-c_C)} = \frac{K_1 \cdot dc_C}{(c_{A,0}-c_C)} + \frac{K_2 \cdot dc_C}{(c_{B,0}-c_C)} = k \cdot dt \quad (\text{Eq.3.25})$$

If we compare the two split fractions with the original fraction, we obtain $K_1 \cdot (c_{B,0} - c_C) + K_2 \cdot (c_{A,0} - c_C) = 1$. The constants K_1 and K_2 can be determined via the boundary conditions, i.e. at $c_C = 0$ we obtain $K_1 \cdot c_{B,0} = 1 - K_2 \cdot c_{A,0}$. At $c_C = c_{A,0}$, we get

$$K_1 = \frac{1}{(c_{B,0}-c_{A,0})} \quad (\text{Eq.3.26})$$

and therefore

$$K_2 = \frac{1}{(c_{A,0}-c_{B,0})} \quad (\text{Eq.3.27})$$

The general quite complicated solution of this equation is then given as:

$$\frac{1}{(c_{B,0}-c_{A,0})} \cdot \ln \frac{c_{A,0}(c_{B,0}-c_C)}{c_{B,0}(c_{A,0}-c_C)} = k \cdot t \quad (\text{Eq.3.28})$$

There exist two procedures to obtain a mathematically more simple solution of the differential equation, using special starting conditions:

- i. If the starting concentrations of both educts are identical, i.e. $c_{A,0} = c_{B,0}$, the differential equation (Eq.3.24) is simply given as:

$$\frac{dc_C}{(c_{A,0}-c_C)^2} = k \cdot dt \quad (\text{Eq.3.29})$$

In this case, we can easily integrate the equation with appropriate boundary conditions

$$\int_0^{c_C} \frac{dc_C}{(c_{A,0}-c_C)^2} = \int_0^t k \cdot dt \quad (\text{Eq.3.30})$$

And obtain:

$$\frac{1}{(c_{A,0}-c_C)} - \frac{1}{c_{A,0}} = k \cdot t \quad (\text{Eq.3.31})$$

- ii. If we choose one component in large excess, e.g. $c_{A,0} \gg c_{B,0}$, the concentration of this component will nearly remain constant during the whole reaction, and again the differential equation (Eq.3.24) becomes fairly simple:

$$\frac{dc_C}{(c_{B,0} - c_C)} = k \cdot c_{A,0} \cdot dt \quad (\text{Eq.3.32})$$

$$\int_0^{c_C} \frac{dc_C}{(c_{B,0} - c_C)} = \int_0^t k \cdot c_{A,0} \cdot dt \quad (\text{Eq.3.33})$$

$$c_C = c_{B,0} - c_{B,0} \cdot \exp[-k \cdot c_{A,0} \cdot t] \quad (\text{Eq.3.34})$$

This 2nd approach is valid for any solvolysis reaction, i.e. a chemical process where component *B* reacts with solvent *A* in dilute solution, for instance methanolysis of carbonic acid chlorides.



CAREER KICKSTART

An app to keep you in the know

Whether you're a graduate, school leaver or student, it's a difficult time to start your career. So here at RBS, we're providing a helping hand with our new Facebook app. Bringing together the most relevant and useful careers information, we've created a one-stop shop designed to help you get on the career ladder – whatever your level of education, degree subject or work experience.

And it's not just finance-focused either. That's because it's not about us. It's about you. So download the app and you'll get everything you need to know to kickstart your career.

So what are you waiting for?

Click [here](#) to get started.



3.2 The kinetics of more complex multistep chemical reactions

3.2.1 The Lindemann-mechanism as an example of a seemingly unimolecular decay process

In practice, for a seemingly unimolecular decay process of type $A \rightarrow B$ in the gas phase, sometimes you encounter reaction orders between 1 and 2, depending on conversion. The simplest mechanism to explain this strange phenomenon was formulated by Lindemann: a combination of a bimolecular equilibrium reaction and a monomolecular final reaction step of an activated species. The Lindemann multistep mechanism reads as following:



A^* is the activated species formed by a bimolecular collision of two molecules of the educt A . This species can either deactivate again by bimolecular collision, or form the product species B by a monomolecular decay. To solve this kinetic problem, we can formulate the following differential equations:

$$\frac{dp_B}{dt} = k_1 \cdot p_{A^*} \quad (\text{Eq.3.36})$$

for the monomolecular product formation from the activated species, and

$$\frac{dp_{A^*}}{dt} = k_2 \cdot p_A^2 - k_{-2} \cdot p_A \cdot p_{A^*} - k_1 \cdot p_{A^*} \quad (\text{Eq.3.37})$$

for the change in partial pressure of the activated species with time. Note that, in contrast to the previous kinetic equations, for the gas phase reaction considered here we have replaced concentrations c with partial pressures p . To solve this equation system even without integration, we may treat the partial pressure p_{A^*} as constant, since the activated species is formed and consumed at equal rates of a certain time regime of our complex reaction (= stationary state). In this case,

$$\frac{dp_{A^*}}{dt} = k_2 \cdot p_A^2 - k_{-2} \cdot p_A \cdot p_{A^*} - k_1 \cdot p_{A^*} = 0 \quad (\text{Eq.3.38})$$

or

$$p_{A^*} = \frac{k_2 \cdot p_A^2}{k_{-2} \cdot p_A + k_1} \quad (\text{Eq.3.39})$$

and consequently

$$\frac{dp_B}{dt} = \frac{k_1 \cdot k_2 \cdot p_A^2}{k_{-2} \cdot p_A + k_1} \quad (\text{Eq.3.40})$$

Consider the denominator of the right side of this rate equation for the formation of product B in more detail: at high pressure of the educt p_A or at an early stage of the reaction, $k_{-2} \cdot p_A \gg k_1$, and therefore

$$\frac{dp_B}{dt} = \frac{k_1 \cdot k_2 \cdot p_A}{k_{-2}} \quad (\text{Eq.3.41})$$

In other words, we find a reaction of 1st order at low conversion. This is plausible since at high p_A all bimolecular reaction steps due to the high collision probability are rather fast, and therefore the slowest reaction step, the monomolecular decay of activated species A^* , determines the overall reaction order.

At low pressure of the educt p_A or at a later stage of the reaction, $k_{-2} \cdot p_A \ll k_1$, and therefore

$$\frac{dp_B}{dt} = k_2 \cdot p_A^2 \quad (\text{Eq.3.42})$$

In this case, we find a 2nd order reaction, since now the collisions become rarer, and therefore the bimolecular collisions as the slowest reactions steps define the overall reaction order.

The Lindemann mechanism is the simplest form of a combined multistep reaction to explain the change in reaction order from 1 to 2 upon proceeding conversion. Note here that the elementary reaction of order 0 described above also is a two-step reaction, explaining in this case the change from reaction order 0 at high educt concentration or low conversion, to reaction order 1 at lower concentration or higher conversion, in which case not any longer all reaction sites of the catalyst will be occupied!

3.2.2 The Michaelis-Menten mechanism as an example of a multistep enzymatic reaction

A very famous multistep reaction similar to the Lindemann mechanism plays an important role in biological enzyme reactions, the Michaelis-Menten process. In this case, an enzyme is serving as a catalyst, and the starting reaction is a bimolecular collision leading to a combined enzyme-substrate-complex. This activated complex can either form the product or be cleaved without changes to the substrate, releasing in both cases the free enzyme E which then may react again. In analogy to the Lindemann mechanism, we may formulate this mechanism as



Let us name the reaction velocity constants related to the equilibrium reaction $E + S \rightleftharpoons ES$ k_1 and k_{-1} , and the constant related to the formation of the product P k_2 . The maximum reaction velocity or highest turnover rate is reached if all enzyme exists in form of the enzyme-substrate complex ES. Next, we define the so-called Michaelis-constant, which corresponds to the substrate concentration at half-saturation of the enzyme, i.e. $c_E = c_{ES} = c_{E_0} \cdot 0.5$, with c_{E_0} the total enzyme concentration. This constant, in case $k_2 \ll k_{-1}$ (= Michaelis-Menten approximation), can be derived as following. Analogous to the Lindemann mechanism, we consider the rate equation for the stationary state:

$$\frac{dc_{ES}}{dt} = 0 = k_1 \cdot c_E \cdot c_S - (k_{-1} + k_2) \cdot c_{ES} \approx k_1 \cdot c_E \cdot c_S - k_{-1} \cdot c_{ES} = 0 \quad (\text{Eq.3.44})$$

or

$$c_S = \frac{k_{-1}}{k_1} \cdot \frac{c_{ES}}{c_E} \quad (\text{Eq.3.45})$$

Therefore, the Michaelis-constant is simply given as

$$K_m = c_S \cdot (v_{max} / 2) = \frac{k_{-1}}{k_1} \quad (\text{Eq.3.46})$$

The product formation reaction velocity in general is given as:

$$\frac{dc_P}{dt} = k_2 \cdot c_{ES} = k_2 \cdot c_S \cdot c_E \cdot K_m^{-1} \quad (\text{Eq.3.47})$$

and

$$k_2 \cdot c_{ES} = k_2 \cdot (c_{E_0} - c_E) = v_{max} - k_2 \cdot c_E \quad (\text{Eq.3.48})$$

Therefore,

$$k_2 \cdot c_S \cdot c_E \cdot K_m^{-1} = v_{max} - k_2 \cdot c_E \quad (\text{Eq.3.49})$$

or

$$c_E = \frac{v_{max}}{(k_2 \cdot c_S \cdot K_m^{-1} + k_2)} \quad (\text{Eq.3.50})$$

ORACLE®

Be BRAVE

enough to reach for the sky

Oracle's business is information - how to manage it, use it, share it, protect it. Oracle is the name behind most of today's most innovative and successful organisations.

Oracle continuously offers international opportunities to top-level graduates, mainly in our Sales, Consulting and Support teams.

If you want to join a company that will invest in your future, Oracle is the company for you to drive your career!

<https://campus.oracle.com>



ORACLE®

ORACLE IS THE INFORMATION COMPANY



Inserting this expression in the reaction velocity finally yields the following Michaelis-Menten relation describing the product formation velocity in dependence of substrate concentration, Michaelis-constant and maximum reaction velocity only:

$$\frac{dc_P}{dt} = k_2 \cdot c_S \cdot c_E \cdot K_m = \frac{v_{max} \cdot k_2 \cdot c_S \cdot K_m^{-1}}{(k_2 \cdot c_S \cdot K_m^{-1} + k_2)} = \frac{v_{max} \cdot c_S}{c_S + K_m} \quad (\text{Eq.3.51})$$

This reaction velocity is plotted in the following figure 3.2, illustrating the practical meaning of important parameters such as maximum velocity or Michaelis-constant for biological enzyme-substrate-reactions.

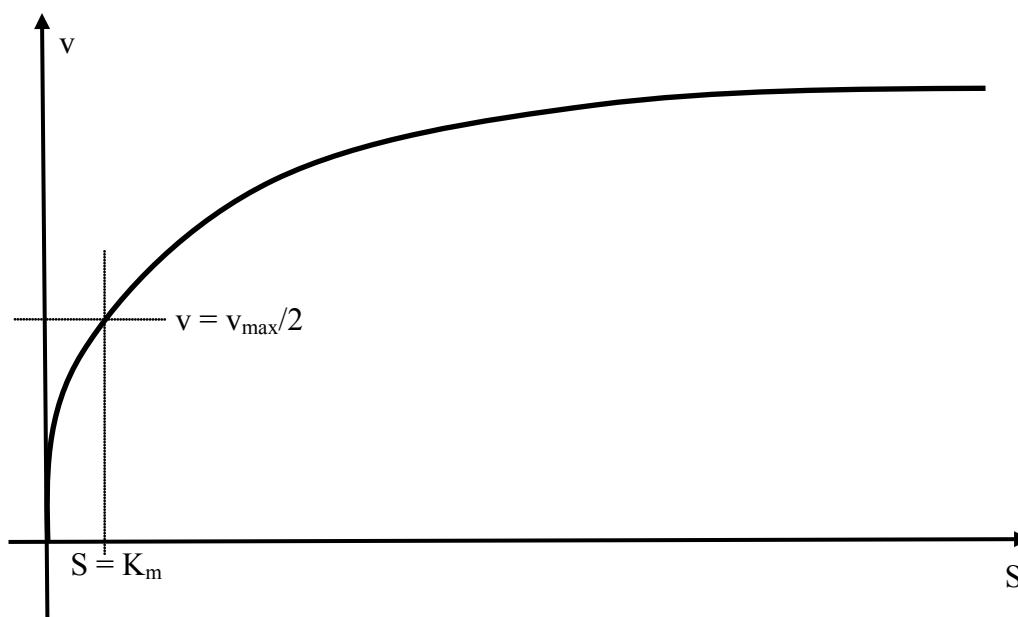

Figure 3.2: Michaelis-Menten kinetics, reaction velocity vs. concentration of the substrate

3.3 Activation energy

So far, we have not considered the dependence of reaction velocity on temperature. Obviously, an increase in temperature leads to an increase in velocity, a concept which was first addressed by Arrhenius (on a purely phenomenological basis!): he assumed that all reactions afford a transitional state located, in respect to the educts, higher in energy by the amount of the activation energy. The ratio of activated to non-activated species at given temperature now is given by the Boltzmann factor (see chapter 2, Eq.2.15), and according to Arrhenius the temperature dependence of the reaction velocity constant is given as:

$$k = A \cdot \exp \left[-\frac{E_A}{RT} \right] \quad (\text{Eq.3.52})$$

RT is the thermal energy per mole, and E_A the activation energy per mole of reacting educt particles. Note that in this simple purely energetic approach A is merely a phenomenological fitting parameter corresponding to the maximum possible reaction velocity, i.e. $k = A$ at $T \rightarrow \infty$. A more sophisticated theory following Eyring, and beyond the scope of this textbook, shows that A is of entropic origin, a concept however not yet known to Arrhenius.

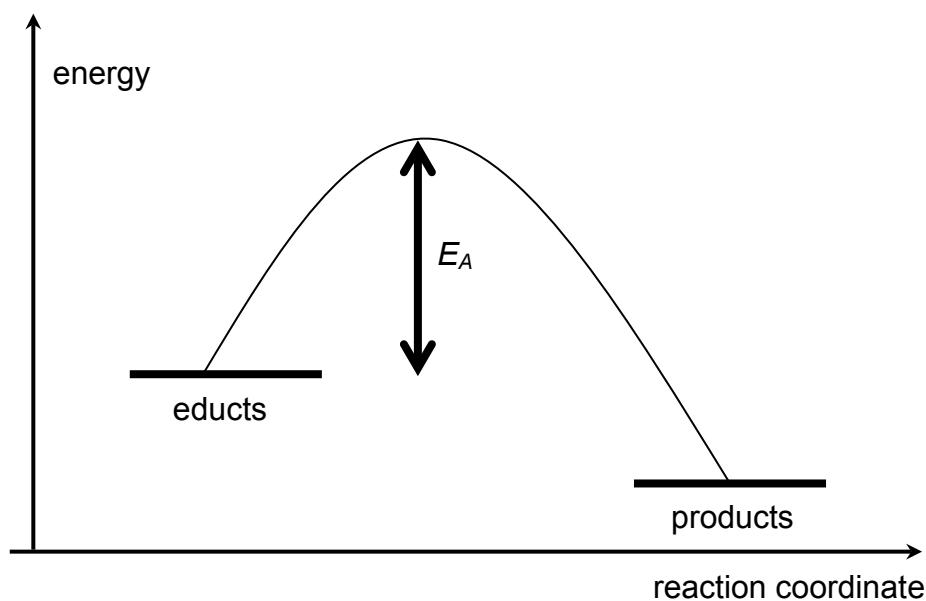

Figure 3.3: Energy profile of a chemical reaction, and activation energy (Arrhenius concept)

The origin of the activation energy barrier E_A is easy to understand if we consider that, for the formation of a new reaction product, first chemical bonds of the original educt molecules have to be broken. This bond energy is in the order of 40–60 kJ/mole, explaining also the famous rule of thumbs that if one increases the temperature of a chemical reaction from room temperature by 10°C, the reaction velocity typically doubles.

Example 3.2:

Consider a chemical reaction with activation energy $E_A = 50 \text{ kJ/mole}$. Which temperature do you need to enhance the reaction velocity, compared to that at room temperature, by a factor of (i) 10 or (ii) 100, respectively?

Solution: we use the Arrhenius equation $k = A \cdot \exp[-E_A/(RT)]$. Note that we will not need A to solve this equation, since we consider only a relative change in velocities in this problem, and not absolute values of the velocity constant:

$$\frac{k(T=293 \text{ K})}{k(T)} = \frac{1}{10} = \frac{A \cdot \exp[-E_A/(R \cdot 293 \text{ K})]}{A \cdot \exp[-E_A/(RT)]} = \frac{\exp[-E_A/(R \cdot 293 \text{ K})]}{\exp[-E_A/(RT)]} = \exp\left[-\frac{E_A}{R} \cdot \left(\frac{1}{293 \text{ K}} - \frac{1}{T}\right)\right]$$

$$\ln 0.1 = -\frac{50000}{8.314} \cdot \left(\frac{1}{293 \text{ K}} - \frac{1}{T}\right)$$

$$\frac{1}{T} = \ln 0.1 \cdot \frac{8.314}{50000} + \frac{1}{293 \text{ K}} = 0.003030 \quad \Rightarrow \quad T = 330 \text{ K} = 56.9 \text{ }^\circ\text{C}$$

Using the same approach we get for an increase in velocity by a factor of 100:

$$\frac{1}{T} = \ln 0.01 \cdot \frac{8.314}{50000} + \frac{1}{293 \text{ K}} = 0.002647 \quad \Rightarrow \quad T = 377.8 \text{ K} = 104.7 \text{ }^\circ\text{C}$$

Cynthia | AXA Graduate

**AXA Global
Graduate Program**

Find out more and apply

redefining / standards



4 Electrochemistry

Electrochemistry plays a very important role both in technology (for example chemical sources of electric energy) and chemical analytics (for example potentiometric or conductivity measurements, both providing a quantitative measure for the concentration of charged solute particles). This chapter is divided in two parts: (1) the transport of charged particles in an electrolyte solution (= ion conductivity), and (2) the electrochemical equilibrium. In the 2nd part, we will address the different types of electrochemical electrodes, and finally combine a pair of electrodes to obtain an electrochemical Galvanic cell.

4.1 Electric Conductivity

An electrochemical cell used, for example, for electrolysis, consists of the source of an electric voltage, as well as of two chemical electrodes immersed typically in an aqueous solution of an electrolyte. The electric circuit consists of negative charges, the electrons, which migrate through all metal parts of this cell, and the ions both positive (cations) and negative (anions) migrating through the aqueous solution towards the respective electrodes. At the electrodes, the ions either release an electron or accept an electron, leading to a respective chemical reaction (oxidation if an electron is released from the ion to the electrode, or reduction if the ion accepts an electron from the electrode).

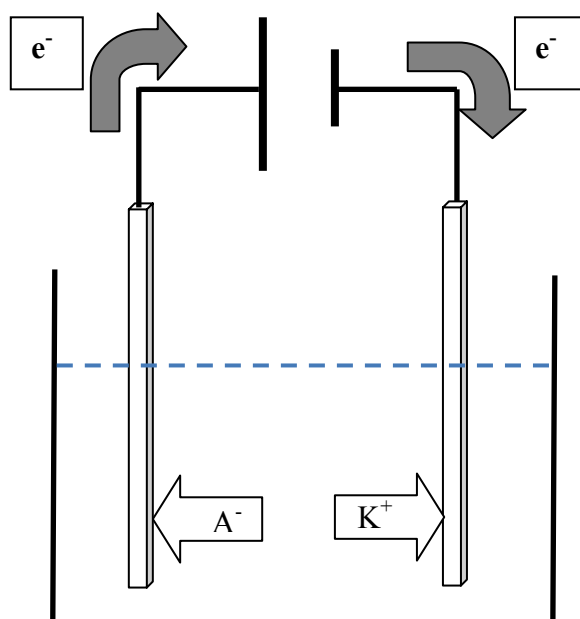
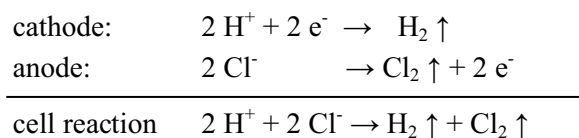

Figure 4.1: electrochemical cell

For example, let us consider two copper electrodes immersed in a dilute aqueous hydrochloric acid solution (this cell is formally expressed as Cu/HCl/Cu, / signifying phase boundaries between the solid copper electrodes and the liquid electrolyte solution, respectively), connected to an external electrical power source to enforce an electrolytic process. The chemical reactions taking place at the two electrodes are then given as:



Note that the number of electrons exchanged per formula equals $z = 2$ for this example.

Michael Faraday discovered the following two laws quantitatively describing the electrolysis:

$$1. \quad m_{\text{H}_2}, m_{\text{Cl}_2} \sim I \cdot t \quad (\text{Eq.4.1})$$

The mass of the material formed at each electrode is proportional to electric current multiplied by time, or total electric charge.

$$2. \quad \frac{m_{\text{H}_2}}{m_{\text{Cl}_2}} = \frac{M_{\text{H}_2}}{M_{\text{Cl}_2}} \quad (\text{Eq.4.2})$$

The mass ratio of materials formed at the respective electrodes is identical to the ratio of the molar masses.

Introducing the Faraday constant, we can combine these two equations to express the total charge exchanged during the electrolysis:

$$Q = I \cdot t = z \cdot N_A \cdot e \cdot \frac{m}{M} = z \cdot F \cdot \frac{m}{M} \quad (\text{Eq.4.3})$$

meaning that the molar amount of material formed at the respective electrodes (m/M) corresponds to the transport of z mole electrons (or the charge zF Coulomb, with the Faraday constant $F = 96484.6 \text{ C mol}^{-1}$) from electrode to electrode via the metal wiring of the electrolysis cell.

To discuss the conductivity and ion migration in a quantitative way, let us consider a more schematic representation of the electrochemical cell:

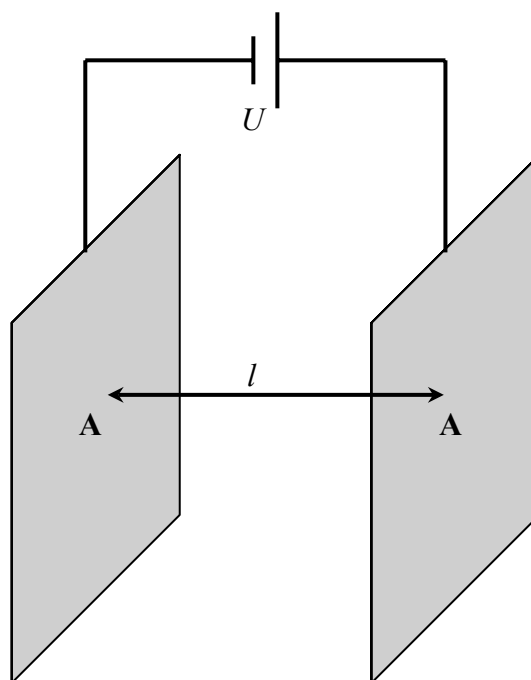

Figure 4.2: schematic presentation of an electrochemical cell

Two electrodes at distance l (within the electrolyte solution) both of area A are connected to an electric power source with voltage U , and immersed in an electrolyte solution. In case the area of the electrodes is larger than the electrode distance squared ($A \gg l^2$), a homogeneous electric field E of magnitude U/l is created. Due to electrostatic interactions, the ions of charge $z_i \cdot e$ are accelerated towards their respective electrodes by an attractive force $F_E = z_i \cdot e \cdot E$. This force is balanced by the frictional force $F_R = 6\pi \cdot \eta \cdot R_i \cdot v_i$, with η the viscosity of the solvent (for water at room temperature, $\eta = 1.00$ mPa s), R_i the radius of the ion, v_i and the velocity of the migrating ion (index i referring to ions of species i , for example H^+ oder Cl^-). At force balance, the acceleration is zero and the ions are migrating with the constant velocity:

$$v_i = \frac{z_i \cdot e \cdot E}{6\pi \cdot \eta \cdot R_i} \quad (\text{Eq.4.4})$$

The ion velocity therefore also depends on the experimental setup, i.e. the electric field strength. One therefore defines, as a more general quantity just depending on material properties, the so-called ion mobility:

$$u_i = \frac{v_i}{E} = \frac{z_i \cdot e}{6\pi \cdot \eta \cdot R_i} \quad (\text{Eq.4.5})$$

This microscopic property is related to the electric conductance (or resistance) of the electrochemical cell, which can more easily be measured than the migration of individual ions. To derive a relation between microscopic ion mobility and macroscopic ion conductance, we consider the electric current within the electrolyte solution, consisting of positive and negative ions migrating in opposite directions:

$$I = \frac{dQ^+}{dt} + \frac{dQ^-}{dt} = \frac{dN^+ \cdot e}{dt} + \frac{dN^- \cdot e}{dt} \quad (\text{Eq.4.6})$$

The amount of negative or positive charges ($dN^+ \cdot e$, $dN^- \cdot e$) migrating within a time step over a certain distance dx towards an electrode of surface area A is given by the average ion concentration and the migration velocity as:

$$\frac{dN^+ \cdot e}{dt} = \frac{dN^+ \cdot e}{A \cdot dx} \cdot A \cdot \left(\frac{dx}{dt}\right)_+ = F \cdot c^+ \cdot A \cdot \left(\frac{dx}{dt}\right)_+ = F \cdot c^+ \cdot A \cdot v^+ \quad (\text{Eq.4.7})$$

with $c^+ = n^+ \cdot z^+ \cdot c$. c is the molar concentration of the electrolyte, n^+ the number of cations per formula, and z^+ the elementary charge number of these cations. For example, for the salt MgCl_2 , $n^+ = 1$ and $z^+ = 2$.

In total, we obtain for the electric current:

$$I = F \cdot A \cdot (c^+ \cdot v^+ + c^- \cdot v^-) = F \cdot A \cdot (c^+ \cdot u^+ + c^- \cdot u^-) \cdot \frac{U}{l} \quad (\text{Eq.4.8})$$

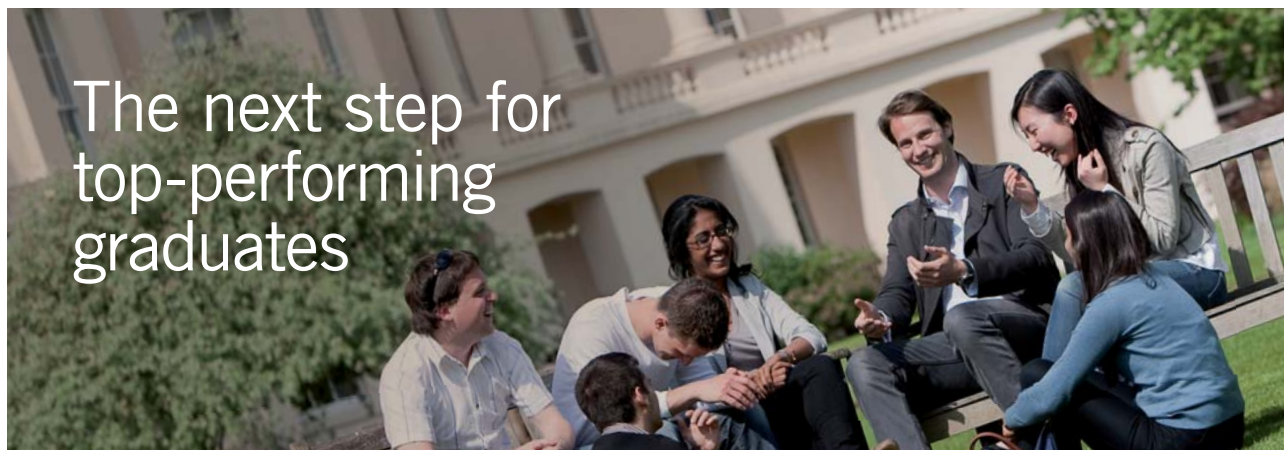

Masters in Management



Designed for high-achieving graduates across all disciplines, London Business School's Masters in Management provides specific and tangible foundations for a successful career in business.

This 12-month, full-time programme is a business qualification with impact. In 2010, our MiM employment rate was 95% within 3 months of graduation*; the majority of graduates choosing to work in consulting or financial services.

As well as a renowned qualification from a world-class business school, you also gain access to the School's network of more than 34,000 global alumni – a community that offers support and opportunities throughout your career.

For more information visit www.london.edu/mm, email mim@london.edu or give us a call on +44 (0)20 7000 7573.

* Figures taken from London Business School's Masters in Management 2010 employment report



Comparing this equation with Ohm's law

$$I = \frac{U}{R} = U \cdot \frac{A}{l} \cdot \frac{1}{\rho} = U \cdot \frac{A}{l} \cdot \kappa \quad (\text{Eq.4.9})$$

we see directly that the resistance R depends on the geometry of our electrochemical cell (= cell constant A/l) and, via the specific resistance ρ or its reciprocal, the specific conductivity κ , on the ion concentration and material properties of the ions (charge, size). Comparing Eqs. (4.8) and (4.9), we find that the specific conductivity, as a macroscopic material property, depends on the microscopic ion mobilities and the electrolyte concentration as:

$$\kappa = F \cdot (c^+ \cdot u^+ + c^- \cdot u^-) \quad (\text{Eq.4.10})$$

To eliminate the concentration dependence, we define the molar conductivity of the electrolyte as:

$$\Lambda = \frac{\kappa}{c} = F \cdot (n^+ \cdot z^+ \cdot u^+ + n^- \cdot z^- \cdot u^-) \quad (\text{Eq.4.11})$$

Note that, by measuring the electric resistance of an electrolyte solution, we determine the sum of the ion mobilities, but not the mobility of one ion species. Importantly, we have to use alternating voltage for this experiment. Otherwise, electrolysis will change the ion concentration with time. In this case, we also would need a certain voltage before the chemical reaction can take place. One experimental setup to measure the electric resistance of an electrolyte solution very accurately is the compensation setup or Wheatstone-bridge (found in common textbooks on experimental physics).

So far, we have shown that the measurement of the electric resistance and calculation of the molar conductivity only yields the sum of cation and anion conductivities

$$\Lambda = F \cdot (n^+ \cdot z^+ \cdot u^+ + n^- \cdot z^- \cdot u^-) = \Lambda_+ + \Lambda_- \quad (\text{Eq.4.12})$$

To directly determine the ion mobility of one ion species, two different experimental approaches may be used:

- i. If the ions absorb visible light, one can directly observe the migration of a colored front moving in an electric field (a special electrochemical cell (formed like a "U") is carefully filled with a solution containing the colored ions, and a colorless electrolyte solution on top in contact with the two electrodes, see textbooks for more details). A famous example is the measurement of the migration of the colorful MnO_4^- -ion.

- ii. If the ions are colorless, the method developed by Hittorf may be used (see fig. 4.3.). A special electrolysis chamber consisting of three different compartments which are separable is used, and the balance of the respective change in electrolyte amount within the two electrode chambers after a defined amount of electric charge has been applied to the cell is determined, respectively, for example by volumetric titration.

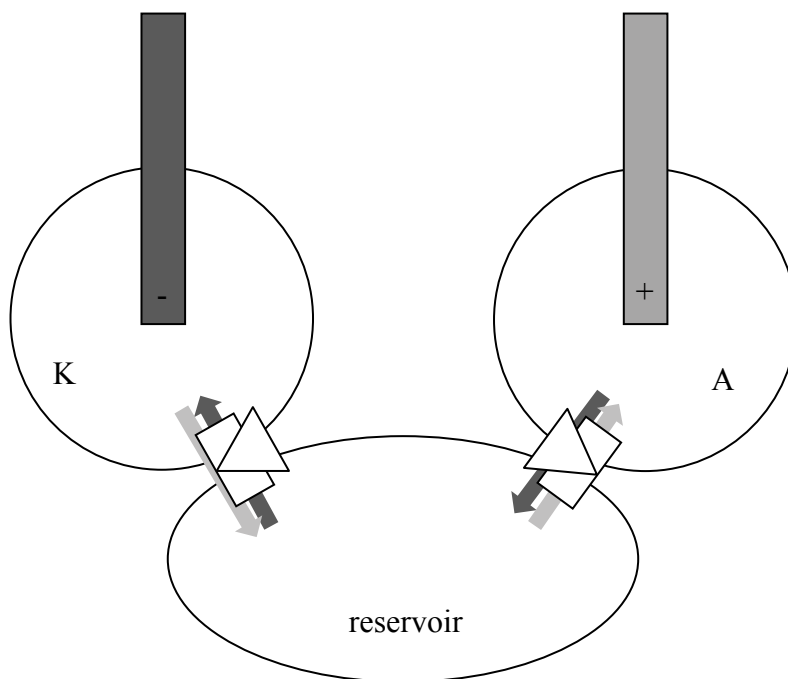

Fig. 4.3: Hittorf electrolysis chamber system (schematic, dark grey arrows = migration of cations, light grey arrows = migration of anions), K = cathode chamber, A = anode chamber

The relative part of the electric current due to cation and anion migration, respectively, is given as

$$\frac{I_+}{I} = \frac{Q_+}{Q_+ + Q_-} = \frac{u_+}{u_+ + u_-} = \frac{\Lambda_+}{\Lambda} = t_+ \tag{Eq.4.13}$$

$$\frac{I_-}{I} = \frac{Q_-}{Q_+ + Q_-} = \frac{u_-}{u_+ + u_-} = \frac{\Lambda_-}{\Lambda} = t_- \tag{Eq.4.14}$$

with t_+ , t_- the Hittorf numbers of the given electrolyte. Note that $t_+ + t_- = 1$. Let us consider the change in electrolyte amount in each electrode chamber if we apply one mole charge to an aqueous solution of HCl for illustration:

<u>cathode chamber</u>	<u>anode chamber</u>	
- 1 mole H^+	- 1 mole Cl^-	change due to electrolysis
- t_- mole Cl^-	+ t_- mole Cl^-	change due to ion migration of Cl^-
+ t_+ mole H^+	- t_+ mole H^+	change due to ion migration of H^+
<hr/>		
- t_- mole HCl	+ t_- mole HCl	overall change in HCl-amount

Determination of the overall change in HCl therefore directly yields the Hittorf numbers. If you independently measure the overall conductivity of the electrolyte, you then can calculate the molar conductivities (and ion mobilities) of the individual ions.

One should note that once you know the total molar conductivity of the electrolyte and the molar conductivity of one ion species, you always can calculate the molar conductivity of the 2nd species. This concept can be used to determine the molar conductivity of the colorless Na⁺-ions, which are also not suitable for direct investigation via the Hittorf method by electrolysis in aqueous solution, as following:

- 1st step: Determine the molar conductivity Λ of the salt NaMnO₄ by measurement of the electric resistance of an aqueous solution.
- 2nd step: Determine the ion mobility of the colored MnO₄⁻ - ions by direct observation of the ion migration within the U-cell, and calculate the molar ion conductivity as $\Lambda_- = F \cdot u_-$.
- 3rd step: You now may calculate the molar ion conductivity of Na⁺ as $\Lambda_+ = \Lambda - \Lambda_-$.

Finally, let us discuss the effect of the hydration shell of associated water molecules formed in aqueous solution on the cation mobility. In dilute aqueous solution, the ion mobility decreases in the order $u(H^+) > u(K^+) > u(Na^+) > u(Li^+)$. This is surprising, since one would expect the Li⁺ - ions to be smaller than the K⁺- ions, for example. However, in aqueous solution the ions are surrounded by a hydration shell of water molecules, and the number of these water molecules is the larger the higher the surface charge density: approximately, the hydration shell of Li⁺ - consists of 12, that of Na⁺ of 8, and that of K⁺ of 4 water molecules, rendering the K⁺-ion effectively smaller and therefore more mobile in aqueous solution.

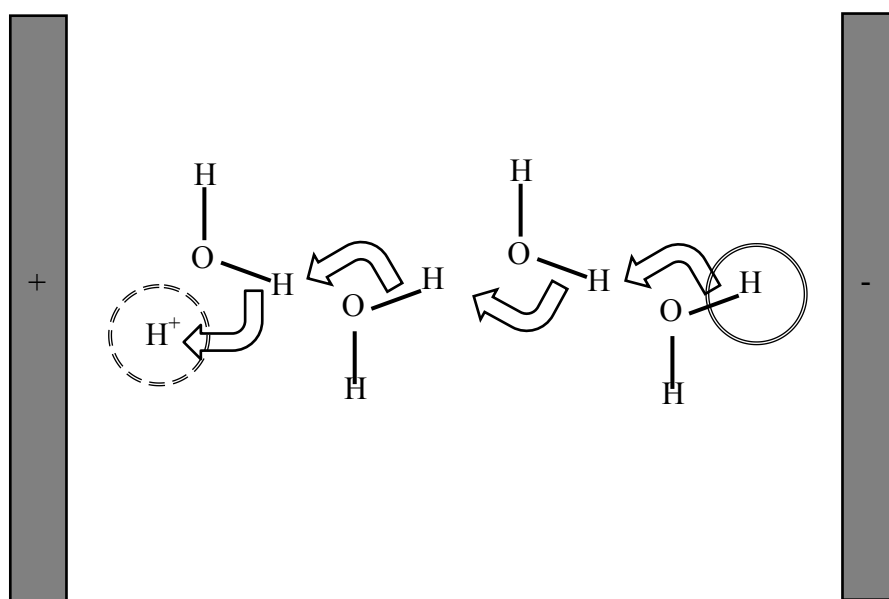

Figure 4.4: The Grotthuß mechanism, explaining the high ion mobility of H⁺ and OH⁻

An exception is H^+ where a special conductivity mechanism takes place (see fig. 4.4): the ion is not itself migrating, but electron pairs are shifted between the ion and neighboring water molecules, leading to an effective charge mobility about 4 times larger than that of migrating ions. A similar mechanism can be formulated to explain the high mobility of OH^- -ions in aqueous solution.

Finally, the ion mobility also depends on temperature, since the viscosity of the solvent and therefore the frictional resistance is decreasing with temperature. Accordingly, ion mobility times solvent viscosity should be independent of temperature ("Walden's Rule").

4.1.1 Electric conductivity of weak electrolytes

For so-called weak electrolytes the molar conductivity is strongly decreasing with increasing concentration of the substrate, for instance acetic acid dissolved in water. The reason is that the weak electrolyte is not fully dissociated except at infinite dilution, and the degree of dissociation is strongly decreasing with increasing concentration. Let us consider the example acetic acid in aqueous solution in more detail. The dissociation of the weak acetic acid is determined by the following chemical equilibrium:



**Get Internationally Connected
at the University of Surrey**

MA Intercultural Communication with International Business
MA Communication and International Marketing



MA Intercultural Communication with International Business
Provides you with a critical understanding of communication in contemporary socio-cultural contexts by combining linguistic, cultural/media studies and international business and will prepare you for a wide range of careers.

MA Communication and International Marketing
Equips you with a detailed understanding of communication in contemporary international marketing contexts to enable you to address the market needs of the international business environment.

For further information contact:
T: +44 (0)1483 681681
E: pg-enquiries@surrey.ac.uk
www.surrey.ac.uk/downloads



The according dissociation constant and degree of dissociation are defined as:

$$K_{diss,c} = \frac{[H^+] \cdot [Ac^-]}{[HAc]} \quad (\text{Eq.4.16})$$

$$\alpha = \frac{[Ac^-]}{[Ac^-] + [HAc]} = \frac{[Ac^-]}{c_0} = \frac{[H^+]}{c_0} = \frac{c_0 - [HAc]}{c_0} \quad (\text{Eq.4.17})$$

Inserting the degree of dissociation α in to $K_{diss,c}$, one obtains:

$$K_{diss,c} = \frac{\alpha \cdot c_0 \cdot \alpha \cdot c_0}{(1-\alpha) \cdot c_0} = \frac{\alpha^2 \cdot c_0}{(1-\alpha)} \quad (\text{Eq.4.18})$$

This quadratic equation may be used to calculate the degree of dissociation as a function of electrolyte concentration c_0 . According to Ostwald, the concentration dependence of the molar conductivity of the weak electrolyte, which is determined by the dissociated charges only, then is given as:

$$\Lambda(c_0) = \alpha \cdot \Lambda_\infty \quad (\text{Eq.4.19})$$

with Λ_∞ the limiting molar conductivity measured at infinite dilution or 100% dissociation $\alpha = 1$.

Experimentally, conductivity measurements can be used to determine the dissociation constant. According to Ostwald's law, $K_{diss,c}$ is given as:

$$K_{diss,c} = \frac{\left(\frac{\Lambda(c_0)}{\Lambda_\infty}\right)^2 \cdot c_0}{\left(1 - \frac{\Lambda(c_0)}{\Lambda_\infty}\right)} \quad (\text{Eq.4.20})$$

or

$$\frac{1}{\Lambda(c_0)} = \frac{c_0 \cdot \Lambda(c_0)}{K_{diss,c} \cdot \Lambda_\infty^2} + \frac{1}{\Lambda_\infty} \quad (\text{Eq.4.21})$$

Measuring the molar conductivity at various concentrations, and plotting $1/\Lambda(c_0)$ versus $c_0 \cdot \Lambda(c_0)$, therefore leads to a straight line yielding Λ_∞ from the intercept, and finally $K_{diss,c}$ from the slope. Note that this method has the major disadvantage that a large experimental error in the intercept causes an even larger error in $K_{diss,c}$. $K_{diss,c}$ may therefore be determined more accurately if Λ_∞ is measured independently, for instance by a clever combination of the molar conductivities of fully dissociated so-called strong electrolytes:

$$\Lambda_\infty(HAc) = \Lambda(HCl) + \Lambda(NaAc) - \Lambda(NaCl) = \Lambda(H^+) + \Lambda(Ac^-) \quad (\text{Eq.4.22})$$

So far, we have ignored the effect of interionic interactions, which cause a decrease in ion mobility with increasing ion concentration. For the weak electrolyte, this contribution is taken into account if in our formulation of K_{diss} we switch from concentrations to so-called activities, i.e.

$$K_{diss} = \frac{a_{Ac^-} \cdot a_{H^+}}{a_{HAc}} = \frac{f_{Ac^-} \cdot c_{Ac^-} \cdot f_{H^+} \cdot c_{H^+}}{f_{HAc} \cdot c_{HAc}} = \frac{f_{\pm}^2 \cdot c_{Ac^-} \cdot c_{H^+}}{f_{HAc} \cdot c_{HAc}} = \frac{f_{\pm}^2}{f_{HAc}} \cdot K_{diss,c} \quad (\text{Eq.4.23})$$

f_{\pm}^2 is the mean-squared ionic activity coefficient, which decreases (from 1 at infinite dilution) with increasing ion concentration. f_{HAc} is the activity coefficient of the uncharged acetic acid molecules, which is close to 1 and nearly independent of concentration. Note that, since f_{\pm}^2 depends on concentration, $K_{diss,c}$ is not a constant!

Finally, also the molar conductivity itself has to be corrected for interionic interactions, and Ostwald's law therefore has to be modified:

$$\Lambda(c_0) = f_{\Lambda} \cdot \alpha \cdot \Lambda_{\infty} \quad (\text{Eq.4.24})$$

As we will show in the next section, according to Poisson-Boltzmann-theory f_{Λ} is given by a square-root dependence on concentration:

$$f_{\Lambda} = 1 - B \cdot \sqrt{c_0} \quad (\text{Eq.4.25})$$

Example 4.1:

Consider two aqueous solutions of a weak organic acid with concentrations 0.1 mol/L and 0.01 mol/L, respectively. The ratio of the electric resistance for these two solutions is 1:3. Calculate the dissociation constant of the acid.

Solution: This problem is related to the conductivity of a weak electrolyte. We therefore have to solve the following set of equations:

$$\Lambda = \alpha \cdot \Lambda_{\infty}, \quad \Lambda = \frac{\kappa}{c} = \frac{\rho^{-1}}{c} = \frac{R^{-1} \cdot A/l}{c}, \quad \text{and} \quad K_s = \frac{\alpha^2 \cdot c}{1-\alpha}.$$

The ratio of Ohm resistances R yields, therefore, a ratio of dissociation constants:

$$\frac{\alpha(c=0.1 \text{ mol/L})}{\alpha(c=0.01 \text{ mol/L})} = \frac{\Lambda(c=0.1 \text{ mol/L})}{\Lambda(c=0.01 \text{ mol/L})} = \left(\frac{R^{-1}(c=0.1 \text{ mol/L}) \cdot A/l}{0.1 \text{ mol/L}} \right) / \left(\frac{R^{-1}(c=0.01 \text{ mol/L}) \cdot A/l}{0.01 \text{ mol/L}} \right) \quad \text{or}$$

$$\frac{\alpha(c=0.1 \text{ mol/L})}{\alpha(c=0.01 \text{ mol/L})} = \left(\frac{3}{0.1 \text{ mol/L}} \right) / \left(\frac{1}{0.01 \text{ mol/L}} \right) = 0.3.$$

We insert this result in K_s and obtain:

$$K_s = \frac{\alpha^2 \cdot c}{1-\alpha} = \frac{\alpha(c=0.01 \text{ mol/L})^2 \cdot 0.01 \text{ mol/L}}{1-\alpha(c=0.01 \text{ mol/L})} = \frac{\alpha(c=0.1 \text{ mol/L})^2 \cdot 0.1 \text{ mol/L}}{1-\alpha(c=0.1 \text{ mol/L})} = \frac{(0.3 \cdot \alpha(c=0.01 \text{ mol/L}))^2 \cdot 0.1 \text{ mol/L}}{1-0.3 \cdot \alpha(c=0.01 \text{ mol/L})}$$

$$\frac{\alpha(c=0.01 \text{ mol/L})^2 \cdot 0.01 \text{ mol/L}}{1-\alpha(c=0.01 \text{ mol/L})} = \frac{(0.3 \cdot \alpha(c=0.01 \text{ mol/L}))^2 \cdot 0.1 \text{ mol/L}}{1-0.3 \cdot \alpha(c=0.01 \text{ mol/L})}$$

$$0.01 \text{ mol/L} \cdot (1 - 0.3 \cdot \alpha(c = 0.01 \text{ mol/L})) =$$

$$0.3^2 \cdot 0.1 \text{ mol/L} \cdot (1 - \alpha(c = 0.01 \text{ mol/L}))$$

$$0.01 - 0.01 \cdot 0.3 \cdot \alpha(c = 0.01 \text{ mol/L}) = 0.3^2 \cdot 0.1 - 0.3^2 \cdot 0.1 \cdot \alpha(c = 0.01 \text{ mol/L})$$

or

$$\alpha(c = 0.01 \text{ mol/L}) = \frac{0.3^2 \cdot 0.1 - 0.01}{0.3^2 \cdot 0.1 - 0.01 \cdot 0.3} = 0.04762, \quad \text{and}$$

$$\alpha(c = 0.1 \text{ mol/L}) = \frac{0.04762}{3} = 0.01587, \quad \text{and therefore finally:}$$

$$K_s = \frac{\alpha^2 \cdot c}{1-\alpha} = \frac{0.04762^2 \cdot 0.01 \text{ mol/L}}{1-0.04762} = \frac{0.01587^2 \cdot 0.1 \text{ mol/L}}{1-0.01587} = 2.4 \cdot 10^{-5} \text{ mol/L}$$

4.1.2 Interionic interactions and the Poisson-Boltzmann-formalism of the Debye-Hückel-theory:

The Debye-Hückel theory is a quantitative model allowing to calculate the mean-squared ionic activity coefficient f_{\pm}^2 (see Eq. (4.23)) based on pure electrostatic interactions and the Boltzmann probability. Qualitatively, we consider the interactions of a central positive ion with a surrounding cloud of negative ions (see fig. 4.5). Note that the overall net charge of the cloud has to be -1, since otherwise the principle of electroneutrality would be violated.

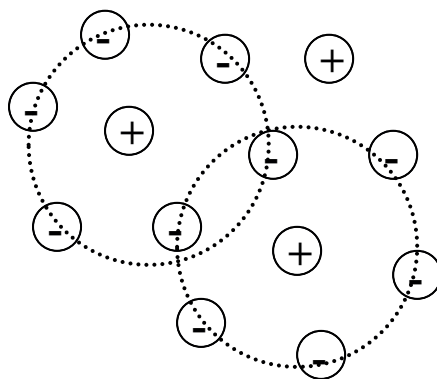

Figure 4.5: The Debye-Hückel model of the counterion cloud

The chemical potential of a 1,1-electrolyte, for example NaCl in aqueous solution, including interionic interactions, is given as

$$\mu = \mu_{(id)} + 2RT \cdot \ln f_{\pm} \quad (\text{Eq.4.26})$$

with $\mu_{(id)}$ the chemical potential in case interionic interactions may be ignored, that is, at infinite dilution of our electrolyte solution. Physically, the interionic interaction per single ion can be expressed as electrical work w to create a central positive charge in presence of the electrostatic potential created by its surrounding ion cloud, or $w = e \cdot \varphi_w(r=0)$, where $\varphi_w(r=0)$ is the electrostatic potential of the ion cloud at the position of the central ion. Note that this work is negative in value, i.e. this charging process leads to a gain in energy! Using this physical concept $\ln f_{\pm}$, can simply be expressed as

$$\ln f_{\pm} = \frac{\mu - \mu_{(id)}}{2RT} = \frac{e \cdot \varphi_w(r=0)}{2RT} \quad (\text{Eq.4.27})$$

Our problem how the ionic activity coefficient (and also the molar ion conductivity) depends on electrolyte concentration is quantitatively solved if we are able to calculate $\varphi_w(r=0)$ as a function of ion concentration. To obtain a general expression for the potential of the ion cloud $\varphi_w(r)$, we consider the potential of the single ion $\varphi_1(r)$ (positive charge 1+) and that of the single ion screened by the surrounding counterion (negative charge 1-) cloud $\varphi_2(r)$. Note that we still limit our formalism, for simplicity of the resulting mathematical expressions, to a 1,1-electrolyte. Having derived the final expression for the ionic activity coefficient, we will finally present the general expression valid for i,j -electrolyte solutions, with $i, j \geq 1$. The electrostatic potentials for our 1,1-electrolyte are given as:

$$\varphi_1(r) = \frac{e}{4\pi\epsilon} \cdot \frac{1}{r} \quad (\text{Eq.4.28})$$

$$\varphi_2(r) = \frac{e}{4\pi\epsilon} \cdot \frac{1}{r} \cdot \exp\left(-\frac{r}{r_D}\right) \quad (\text{Eq.4.29})$$

ϵ is the permittivity of the solvent, and r_D is the screening length of our screened Coulomb repulsion, at this stage still a non-specified parameter. The electrostatic potentials given by Eqs. (4.28) and (4.29), respectively, are compared in fig. 4.6. Next, we will calculate the Debye screening length r_D , which is directly related to the ionic activity coefficient f_{\pm} .

STEP INTO A WORLD OF OPPORTUNITY

www.ecco.com/trainees
trainees@ecco.com

eCCO®



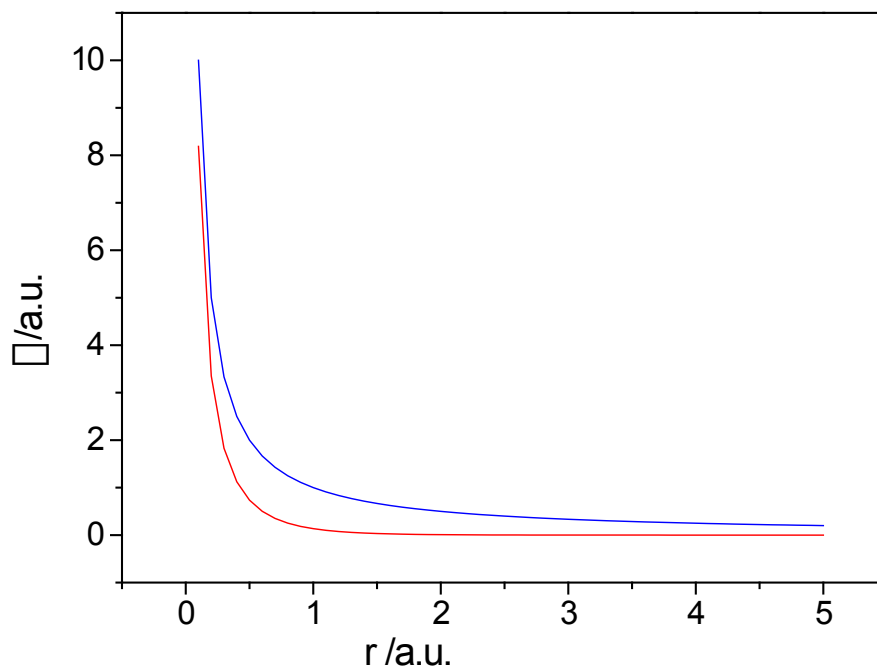

Figure 4.6: electrostatic potential of a single ion (blue), and a single ion including the counterion cloud (red)

We start our calculation of r_D with the Poisson-equation, one of the Maxwell equations connecting a radial-symmetric charge density profile $\rho_i(r)$ with the corresponding electrostatic potential $\varphi_i(r)$:

$$\frac{1}{r^2} \cdot \frac{d}{dr} \left\{ r^2 \cdot \frac{d\varphi_i(r)}{dr} \right\} = -\frac{\rho_i(r)}{\varepsilon} \quad (\text{Eq.4.30})$$

Inserting our approach for the screened Coulomb potential ((Eq.4.29)) into the Poisson-equation (Eq. (4.30)) leads to:

$$\frac{\varphi_i(r)}{r_D^2} = -\frac{\rho_i(r)}{\varepsilon} \quad (\text{Eq.4.31})$$

This equation can be solved if we consider also the Boltzmann equation (see Chapter 2, Eq.(2.15)) to express the local charge density of ions of species j at distance r from our central ion i ($N_j(r)$). The local ion concentration $N_j(r)$ depends on the ratio of electrostatic interaction energy to thermal energy $k_B T$ (with the Boltzmann constant $k_B = R/N_A$, R = universal gas constant, N_A = Avogadro number, see also chapter 2) as:

$$\frac{N_j(r)}{\langle N_j \rangle} = \exp\left(-\frac{e \cdot \varphi_i(r)}{k_B T}\right) \quad (\text{Eq.4.32})$$

$\langle N_j \rangle$ is the average concentration of ions of species j . Note that at very high temperature, $N_j(r) = \langle N_j \rangle$, i.e. the concentration of ions of species j is constant all over the electrolyte solution, whereas at lower temperatures ions and counterions form a regular alternating spatial arrangement as sketched in fig. 4.5 (= the ion cloud model).

Considering both positive and negative ions, we get a local charge density distribution as a function of distance r in respect to our central cation given as:

$$\rho_i(r) = N_+(r) \cdot e - N_-(r) \cdot e = \langle N \rangle \cdot e \cdot \exp\left(-\frac{e \cdot \varphi_i(r)}{k_B T}\right) - \langle N \rangle \cdot e \cdot \exp\left(\frac{e \cdot \varphi_i(r)}{k_B T}\right) \quad (\text{Eq.4.33})$$

Note again that, for simplification, here we have considered ions of charges +1 or -1, only, and $\langle N_+ \rangle = \langle N_- \rangle = \langle N \rangle$ (that is, the average particle number concentrations are identical for cations and anions).

Usually, the electrostatic interaction energy is small compared to $k_B T$ (weak perturbation), and using a Taylor series expansion of the exponential function the local charge density can therefore be written simply as:

$$\rho_i(r) = \langle N \rangle \cdot e \cdot \left(1 - \frac{e \cdot \varphi_i(r)}{k_B T}\right) - \langle N \rangle \cdot e \cdot \left(1 + \frac{e \cdot \varphi_i(r)}{k_B T}\right) = -\frac{2 \cdot e^2 \cdot \varphi_i(r)}{k_B T} \cdot \langle N \rangle \quad (\text{Eq.4.34})$$

To treat the general case of multivalent ions, it is better to express $\rho_i(r)$ in dependence of the ionic strength instead of in dependence of the average ion number concentration $\langle N \rangle$:

$$\rho_i(r) = -\frac{2 \cdot e^2 \cdot \varphi_i(r)}{k_B T} \cdot \rho \cdot N_A \cdot m^\emptyset \cdot I \quad (\text{Eq.4.35})$$

ρ is the density of the solvent, N_A the Avogadro number, and m^\emptyset a dimensionality factor ($m^\emptyset = 1 \text{ mole/kg}$). The ionic strength itself is defined as following:

$$I = \frac{1}{2} \cdot \sum_j \left(\frac{m_j}{m^\emptyset}\right) \cdot z_j^2 \quad (\text{Eq.4.36})$$

with m_j the molality of ions of species j . As an illustrative example, consider 0.5 m NaCl:

$$I = \frac{1}{2} \cdot \{0.5 \cdot 1^2 + 0.5 \cdot (-1)^2\} = 0.5 \quad (\text{Eq.4.37})$$

With

$$\langle N \rangle = \rho \cdot N_A \cdot m^\emptyset \cdot I \quad (\text{Eq.4.38})$$

we get an average ion number concentration of $0.5 \cdot N_A$ per liter for both ionic species.

If we relate the expression $\rho_i(r) = -\frac{2 \cdot e^2 \cdot \varphi_i(r)}{kT} \cdot \rho \cdot N_A \cdot m^\theta \cdot I$ (Eq.4.35) with the result of the Poisson equation $\frac{\varphi_i(r)}{r_D^2} = -\frac{\rho_i(r)}{\epsilon}$ (Eq.4.31), we obtain the following expression for the ion concentration dependence of our screening length r_D :

$$r_D^2 = \frac{\epsilon \cdot RT}{2 \cdot \rho \cdot (e \cdot N_A)^2 \cdot I \cdot m^\theta} = \frac{\epsilon \cdot RT}{2 \cdot \rho \cdot F^2 \cdot I \cdot m^\theta} \quad (\text{Eq.4.39})$$

with the Faraday constant $F = eN_A = 96484.6 \text{ C/mole}$.

Our final goal was to express not the screening length but the mean-squared ionic activity coefficient f_{\pm}^2 as a function of ion concentration (or ionic strength). For this purpose, we still have to show how $\varphi_w(r=0)$ depends on the Debye screening length r_D . The electrostatic potential of the ion cloud $\varphi_w(r)$ is simply given by the difference of the potentials $\varphi_1(r)$ and $\varphi_2(r)$ (see Eqs.4.28, 4.29), i.e.:

$$\varphi_w(r) = \varphi_2(r) - \varphi_1(r) = \frac{e}{4\pi\epsilon} \cdot \frac{1}{r} \cdot \left(\exp\left(-\frac{r}{r_D}\right) - 1 \right) \quad (\text{Eq.4.40})$$

For small distances r from the central ion, we can use a Taylor series expansion for the exponential in (Eq.4.40), and obtain:

$$\varphi_w(r=0) = \frac{e}{4\pi\epsilon} \cdot \frac{1}{r} \cdot \left(1 - \frac{r}{r_D} - 1 \right) = -\frac{e}{4\pi\epsilon} \cdot \frac{1}{r_D} \quad (\text{Eq.4.41})$$

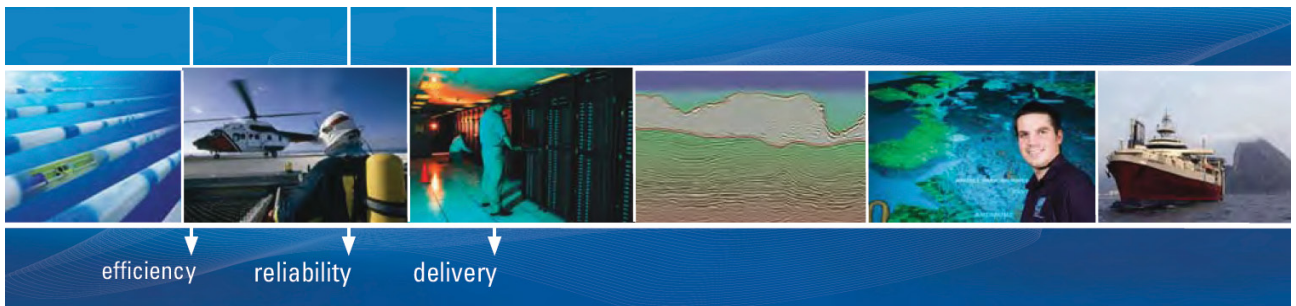

As a leading technology company in the field of geophysical science, PGS can offer exciting opportunities in offshore seismic exploration.

We are looking for new BSc, MSc and PhD graduates with Geoscience, engineering and other numerate backgrounds to join us.

To learn more our career opportunities, please visit www.pgs.com/careers

A Clearer Image
www.pgs.com



Formally, the electrostatic potential of the ion cloud therefore corresponds simply to the Coulomb attraction potential of a single anion at interionic distance r_D ! The electrostatic work W to charge one mole of cations from zero charge to charge e against this electrostatic potential of the counterion cloud is then given as:

$$W = N_A \cdot \int_0^{Q=e} \varphi_w(r=0) dQ = -\frac{N_A}{4\pi\epsilon \cdot r_D} \int_0^{Q=e} Q dQ = -\frac{N_A}{4\pi\epsilon \cdot r_D} \cdot \frac{1}{2} \cdot e^2 = -\frac{F^2}{8\pi\epsilon \cdot N_A \cdot r_D} \quad (\text{Eq.4.42})$$

In (Eq.4.42), the infinitesimal work to charge a single ion in respect to a constant electrostatic potential created by the surrounding ion cloud of counterions is given as $dw = \varphi_w(r=0)dQ$, and therefore the total work per ion to achieve a final charge of e is $w = \int_0^{Q=e} \varphi_w(r=0)dQ$.

Finally, the mean-squared ionic activity coefficient f_{\pm}^2 of the electrolyte is given by considering both cationic and anionic species, leading to:

$$\ln f_{\pm} = \frac{N_+ \cdot W + N_- \cdot W}{(N_+ + N_-) \cdot RT} = -\frac{F^2}{8\pi\epsilon \cdot N_A \cdot r_D \cdot RT} = -k \cdot \frac{1}{r_D} = -k' \cdot \sqrt{I} = -k'' \cdot \sqrt{c} \quad (\text{Eq.4.43})$$

For aqueous solutions at $T = 25^\circ\text{C}$, Eq.4.43 yields:

$$\ln f_{\pm} = -0.509 \cdot |z_+ \cdot z_-| \cdot \sqrt{I} \quad (\text{Eq.4.44})$$

This square-root dependence of the activity coefficient on ionic strength also leads to a square-root dependence of the molar conductivity of strong electrolytes in solution (an exact derivation is beyond the scope of this book), as described by the famous \sqrt{c} -law by Kohlrausch:

$$\Lambda(c_0) = \Lambda_{\infty} - B \cdot \sqrt{c_0} \quad (\text{Eq.4.45})$$

In summary, interionic interaction increasing with ion concentration therefore leads to a systematic decrease in the molar conductivity. Qualitatively, and as a conclusion to this mathematically quite elaborate section, we consider the interionic interaction of a central ion with its surrounding counter ion cloud via two simplified pictures (see figs. 4.7, 4.8):

(i) relaxation of the ion cloud:

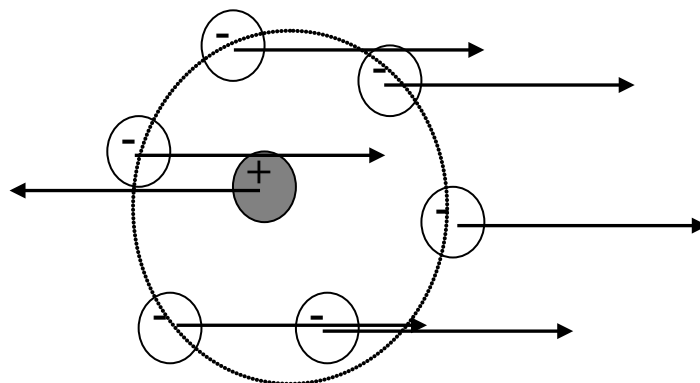

Figure 4.7: relaxation of the ion cloud

Consider the migration of the positively charged central ion to the left, and the migration of the negatively charged ion cloud to the right according to the electrostatic attractions caused by the respective electrodes. As a consequence, a dipole is created, or charge neutrality is destroyed on a local level. This leads to a retardation force, i.e. the migrating anions are pulling back the cation towards the center of the counter ion cloud, and vice-versa.

(ii) electrophoretic effect:

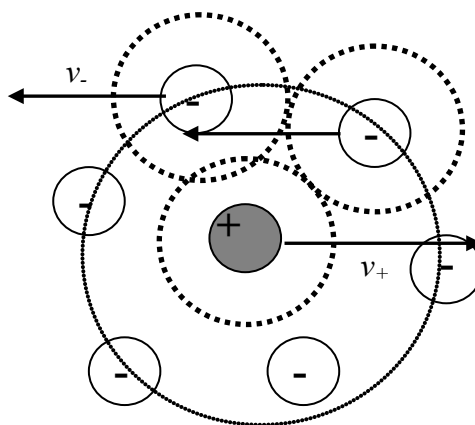

Figure 4.8: electrophoretic effect:

The frictional force is enhanced due to the fact that hydration shells of ions moving into opposite directions are in close contact. Therefore, the frictional force determined by the relative velocity difference is stronger than that of a single ion moving through solvent molecules which on average do not move in a specific direction.

To conclude this section about ion conductivity in electrolyte solutions, fig. 4.9 shows the concentration dependence of the molar ion conductivity of two strong acids and one weak acid in aqueous solution, illustrating the difference between weak and strong electrolytes.

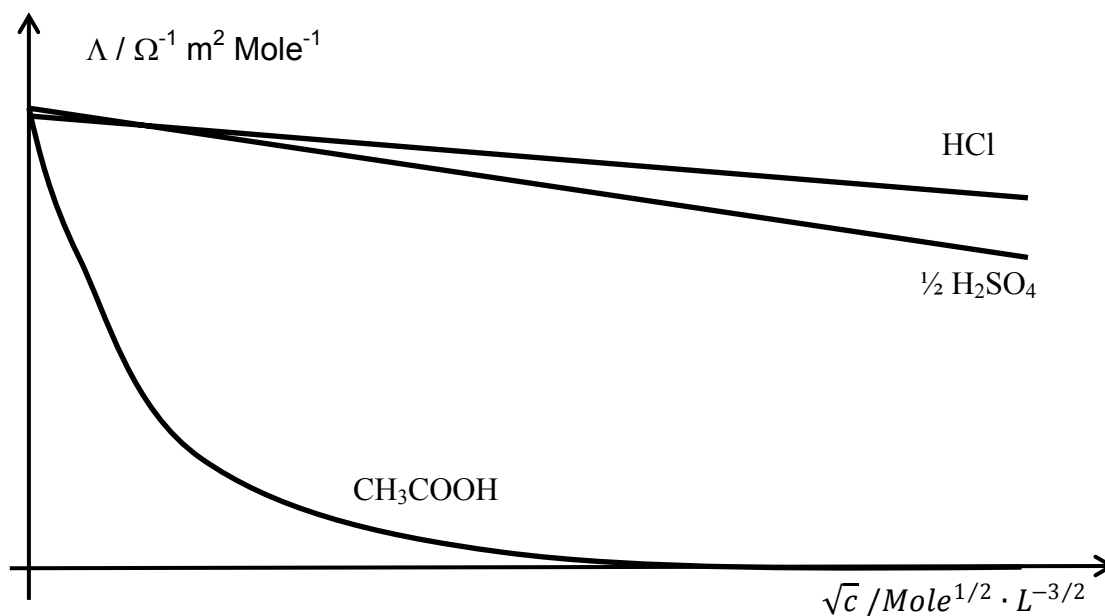
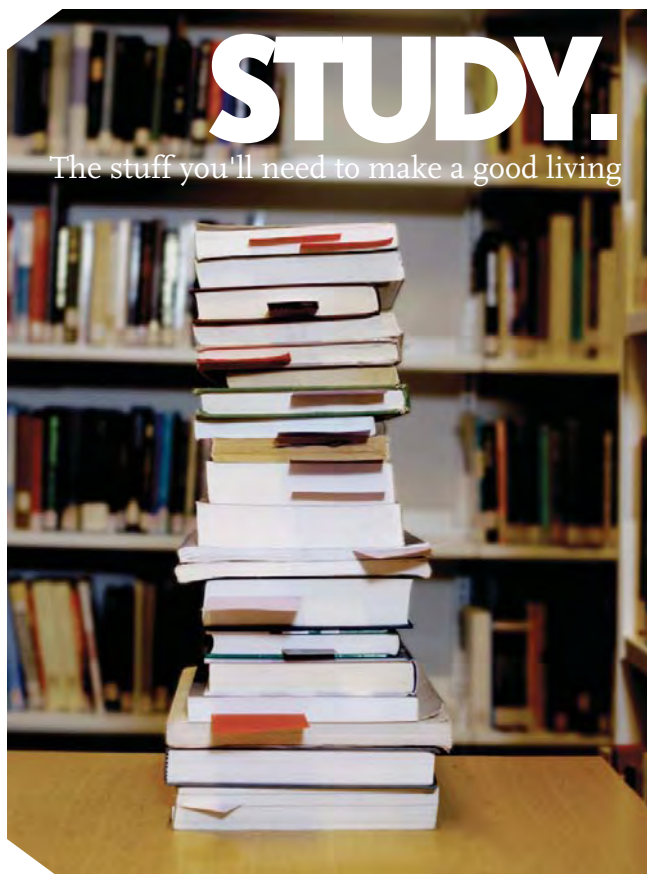

Figure 4.9: concentration dependence of the molar conductivity of various aqueous acidic solutions



4.2 The electrochemical potential and electrochemical cells

4.2.1 Chemical electrodes

A system consisting of a metallic rod immersed in an aqueous solution containing the corresponding metal cations shows the following chemical equilibrium:



Cations are migrating to the metal rod (or metal electrode), take up electrons from the metal and adsorb as metal atoms (reduction), or – the opposite reaction – metal atoms release z electrons to the metal rod and migrate into solution as metal ions (oxidation). Which process is favored depends in practice on the counter electrode, a 2nd chemical electrode which closes the electric circuit (see fig. 4.1)!

The reduction process causes the electrode to assume a positive charge, whereas the oxidation leads to a negatively charged electrode, and correspondingly a negative electric potential (electrode respective to solvent) $\Delta\varphi$. In Eq. (4.46), (aq) means dissolved in water, and (s) means solid phase.

For a given chemical electrode, its electric potential $\Delta\varphi$, related to the difference in electric charge between the aqueous and the solid phase, is determined by the electrochemical potentials of the products and educts of the above redox reaction. In general, an electrochemical potential is defined as chemical potential plus electrostatic interaction energy, i.e.

$$\overline{\mu}_i = \mu_i + N_A z_i e \varphi = \mu_i + z_i F \varphi \quad (\text{Eq.4.47})$$

Our electrochemical equilibrium therefore is given as:

$$\mu_{M(s)} = \overline{\mu_{M^{z+}(aq)}} + z \overline{\mu_{e^{-}(s)}} \quad (\text{Eq.4.48})$$

with $\mu_{M(s)}$ the chemical potential of the uncharged metal electrode, and the two electrochemical potentials given as:

$$\overline{\mu_{M^{z+}(aq)}} = \mu_{M^{z+}(aq)} + zF\varphi(aq) \quad (\text{Eq.4.49})$$

$$\overline{\mu_{e^{-}(s)}} = \mu_{e^{-}(s)} - F\varphi(s) \quad (\text{Eq.4.50})$$

In Eqs.4.48 and 4.49, z is the charge number of the metal ions in solution, for example for Cu^{2+} $z=2$. The electrostatic potential difference $\Delta\varphi = \varphi(s) - \varphi(aq)$ between the solid and the aqueous phase in electrochemical equilibrium is then given by inserting Eqs.4.49 and 4.50 into Eq.4.48, and resolving for $\Delta\varphi$:

$$\Delta\varphi = \varphi(s) - \varphi(aq) = \frac{1}{zF} \cdot \{\mu_{M^{z+}(aq)} + z\mu_{e^-(s)} - \mu_{M(s)}\} \quad (\text{Eq.4.51a})$$

or

$$\Delta\varphi = \varphi(s) - \varphi(aq) = \frac{1}{zF} \cdot \{\mu_{M^{z+}(aq)}^\ominus + RT \cdot \ln a_{M^{z+}} + z\mu_{e^-(s)} - \mu_{M(s)}\} \quad (\text{Eq.4.51b})$$

$\mu_{M^{z+}(aq)}^\ominus$ is the chemical potential of the metal ions in aqueous solution at standard conditions, i.e. concentration 1 mole/kg solvent excluding interionic interactions (pseudo-ideal solution, not a real system since at such high concentration, as shown in the previous section, Poisson-Boltzmann-theory predicts strong interionic interactions). $a_{M^{z+}}$ is the activity of the metal ions in the solution. Per definition, all chemical potentials of solid phases are constant and therefore defined as zero (or, more accurately, included in the standard electric potential difference of the respective electrode). In conclusion, the electrode potential therefore depends on the materials and the ion concentration as:

$$\Delta\varphi = \Delta\varphi^\ominus + \frac{RT}{zF} \cdot \ln a_{M^{z+}} \quad (\text{Eq.4.52})$$

with the electric standard potential of the chemical electrode $\Delta\varphi^\ominus$ given as

$$\Delta\varphi^\ominus = \frac{1}{zF} \cdot \{\mu_{M^{z+}(aq)}^\ominus + z\mu_{e^-(s)} - \mu_{M(s)}\} \quad (\text{Eq.4.53})$$

i.e. corresponding to an idealized aqueous solution at standard conditions, i.e. concentration 1 mole/kg solvent excluding interionic interactions, therefore activity $a_{M^{z+}} = 1$.

More general, for any redox reaction of type $\text{OX} + ze^- \rightleftharpoons \text{RED}$ we can define an electrode potential difference as:

$$\Delta\varphi = \Delta\varphi^\ominus + \frac{RT}{zF} \cdot \ln \frac{a_{\text{OX}}}{a_{\text{RED}}} \quad (\text{Eq.4.54})$$

The electrode itself is formulated as RED, OX/M. Note that only components in the solute phase, typical aqueous solution, or gases will explicitly contribute to the concentration-dependent term in the logarithm. An alternative formulation is based on the chemical equilibrium, i.e.

$$\Delta\varphi = \Delta\varphi^\ominus_{\text{RED,OX/M}} - \frac{RT}{zF} \cdot \ln \frac{a_{\text{RED}}}{a_{\text{OX}} \cdot a_{e^-(s)}^z} = \Delta\varphi^\ominus_{\text{RED,OX/M}} - \frac{RT}{zF} \cdot \ln K \quad (\text{Eq.4.55})$$

Note that, per definition, $a_{e^-(s)} = 1$.

To illustrate the meaning of this general equation (4.55), let us consider in detail examples for the most important types of chemical electrodes:

i. gas electrodes

A famous very important example is the hydrogen electrode $H^+(aq)/H_2(g)/Pt$, which is also used as the reference system, i.e. $\Delta\varphi^{\ominus}_{Pt/H_2(g)/H^+(aq)}$ of this electrode is set to zero. Note that electrode potentials can only be measured within a closed electric circuit, that is, in reference to each other. Therefore, there exists no stand-alone absolute electrode potential, but all data are based on the $H^+(aq)/H_2(g)/Pt$ reference system, leading to the electrochemical potential series found in all textbooks of Physical Chemistry. In this system, the electrochemical standard potential of any given chemical electrode corresponds to the electric potential difference one would measure in respect to the hydrogen electrode, using standard conditions, i.e. $p = 1$ bar, $T = 298.15$ K and activities of ions and gases = 1.



**Technical training on
WHAT you need, WHEN you need it**

At IDC Technologies we can tailor our technical and engineering training workshops to suit your needs. We have extensive experience in training technical and engineering staff and have trained people in organisations such as General Motors, Shell, Siemens, BHP and Honeywell to name a few.

Our onsite training is cost effective, convenient and completely customisable to the technical and engineering areas you want covered. Our workshops are all comprehensive hands-on learning experiences with ample time given to practical sessions and demonstrations. We communicate well to ensure that workshop content and timing match the knowledge, skills, and abilities of the participants.

We run onsite training all year round and hold the workshops on your premises or a venue of your choice for your convenience.

For a no obligation proposal, contact us today at training@idc-online.com or visit our website for more information: www.idc-online.com/onsite/

OIL & GAS ENGINEERING

ELECTRONICS

AUTOMATION & PROCESS CONTROL

MECHANICAL ENGINEERING

INDUSTRIAL DATA COMMS

ELECTRICAL POWER

Phone: +61 8 9321 1702
Email: training@idc-online.com
Website: www.idc-online.com

IDC TECHNOLOGIES

Nobler metals, like copper, silver etc., in respect to this hydrogen standard show a positive electrode potential, whereas less noble metals, like iron, zinc etc., show a negative potential. This means that, at standard conditions (ion concentration in the aqueous phase 1 mole/kg, pressure of gases contributing to the electrode potential 1 bar), a zinc electrode combined with the hydrogen electrode to one electric circuit will show spontaneous oxidation of zinc and reduction of hydrogen ions, whereas a copper electrode combined with the hydrogen electrode will show reduction of copper ions and oxidation of hydrogen gas.

The $H^+(aq)/H_2(g)/Pt$ electrode is based on the following redox equilibrium, using a Pt wire to transfer the electrons between hydrogen gas and protons:



The electrochemical equilibrium is defined via the respective chemical or electrochemical potentials as:

$$\frac{1}{2} \mu_{H_2(g)} = \overline{\mu_{H^+(aq)}} + \overline{\mu_{e^-(s)}} \quad (\text{Eq.4.57})$$

According to the general scheme, the electrostatic electrode potential difference then is given as:

$$\Delta\varphi = \varphi(s) - \varphi(aq) = \frac{1}{F} \cdot \{ \mu_{H^+(aq)}^\ominus + RT \cdot \ln a_{H^+(aq)} + z\mu_{e^-(s)} - \mu_{H_2(g)}^\ominus - RT \cdot \ln f_{H_2(g)} \} \quad (\text{Eq.4.58})$$

Here, $f_{H_2(g)}$ is the fugacity of the hydrogen gas (or effective pressure), defined as

$$f_{H_2(g)} = \frac{y \cdot p_{H_2}}{p^\ominus} \quad (\text{Eq.4.59})$$

with $y \leq 1$ an activity coefficient (taking into account the difference between ideal and real gas, see chapter 2), and p^\ominus the standard pressure 1 bar. Combining all concentration-independent terms then leads to:

$$\Delta\varphi = \Delta\varphi_{Pt/H_2(g)/H^+(aq)}^\ominus + \frac{RT}{F} \cdot \ln \frac{a_{H^+(aq)}}{f_{H_2(g)}^{0.5}} \quad (\text{Eq.4.60})$$

ii. electrodes of 2nd type

In case the cation concentration is determined via the solubility of a nearly insoluble salt, using 1 mole/kg of the counterions as the standard condition, an electrode of 2nd type is obtained. Examples are the Calomel-electrode $Cl^-(aq)/Hg_2Cl_2(s)/Hg(l)$ or the silver/silver chloride electrode $Cl^-(aq)/AgCl(s)/Ag(s)$. For the later, the following redox equilibrium is the basis of the electrode's potential:

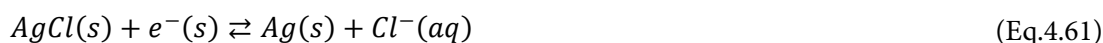

We use the general expression for the electrode potential of any chemical redox electrode

$$\Delta\varphi = \Delta\varphi^\ominus + \frac{RT}{zF} \cdot \ln \frac{a_{OX}}{a_{RED}} \quad (\text{Eq.4.62})$$

and consider that on the “OX-side” there are only solid components with activity 1, whereas on the “RED-side” the only non-solid component is $Cl^-(aq)$. Consequently, the electrode’s potential is given as:

$$\Delta\varphi = \Delta\varphi^\ominus_{Cl^-(aq)/AgCl(s)/Ag(s)} + \frac{RT}{F} \cdot \ln \frac{1}{a_{Cl^-}} = \Delta\varphi^\ominus_{Cl^-(aq)/AgCl(s)/Ag(s)} - \frac{RT}{F} \cdot \ln a_{Cl^-} \quad (\text{Eq.4.63})$$

This electrode of 2nd type provides a nice example how the solubility constant of can be calculated from standard electrode potentials. The $Cl^-(aq)/AgCl(s)/Ag(s)$ -electrode can formally be considered also as a simple $Ag^+(aq)/Ag(s)$ -electrode, where the effective concentration of Ag^+ -ions is determined by the solubility product,

$$K_{L,AgCl} = a_{Ag^+} \cdot a_{Cl^-} \quad (\text{Eq.4.64})$$

The electrode potential therefore can be expressed in two different ways:

$$\Delta\varphi = \Delta\varphi^\ominus_{Cl^-(aq)/AgCl(s)/Ag(s)} - \frac{RT}{F} \cdot \ln a_{Cl^-} = \Delta\varphi^\ominus_{Ag^+(aq)/Ag(s)} + \frac{RT}{F} \cdot \ln a_{Ag^+} \quad (\text{Eq.4.65})$$

Eq. (4.65) yields for the solubility constant $K_{L,AgCl}$:

$$\Delta\varphi^\ominus_{Cl^-(aq)/AgCl(s)/Ag(s)} - \Delta\varphi^\ominus_{Ag^+(aq)/Ag(s)} = \frac{RT}{F} \cdot (\ln a_{Ag^+} + \ln a_{Cl^-}) = \frac{RT}{F} \cdot \ln K_{L,AgCl} \quad (\text{Eq.4.66})$$

With $\Delta\varphi^\ominus_{Cl^-(aq)/AgCl(s)/Ag(s)} = 0.22 \text{ V}$ and $\Delta\varphi^\ominus_{Ag^+(aq)/Ag(s)} = 0.80 \text{ V}$ (from the series of standard electrode potentials) we obtain $K_{L,AgCl} \approx 1.5 \cdot 10^{-10} \text{ mole}^2/\text{kg}^2$.

iii. redox electrodes

As we have seen, every chemical electrode is based on a redox reaction. However, in practice you call an electrode a redox electrode if both the OX-species and the RED-species are found in the solute phase, typically an aqueous solution. Examples are the $Fe^{2+}(aq), Fe^{3+}(aq)/Pt(s)$ - electrode or the *Hydrochinon*(aq), *Chinon*(aq)/Pt(s)-electrode. Note that there is no phase boundary between the OX and RED species, wherefore the / is replaced by a. The respective redox reactions and electrode potentials are given as:



$$\Delta\varphi = \Delta\varphi^\ominus_{Fe^{2+}(aq), Fe^{3+}(aq)/Pt(s)} + \frac{RT}{F} \cdot \ln \frac{a_{Fe^{3+}(aq)}}{a_{Fe^{2+}(aq)}} \quad (\text{Eq.4.68})$$

and

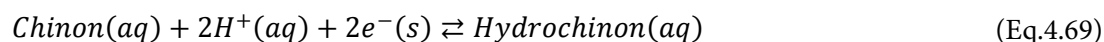

$$\Delta\varphi = \Delta\varphi^{\ominus}_{\text{Hydrochinon}(aq),\text{Chinon}(aq)/\text{Pt}(s)} + \frac{RT}{2F} \cdot \ln \frac{a_{\text{Chinon}(aq)} \cdot a_{H^+(aq)}^2}{a_{\text{Hydrochinon}(aq)}} \quad (\text{Eq.4.70})$$

Note that the Chinon/Hydrochinon (or Chinhydrin) – electrode can also be used to measure pH-values of aqueous solutions, since its electrode potential depends on $a_{H^+(aq)}^2$. This electrode is much better suited for this purpose than the $\text{Pt}/\text{H}_2(g)/\text{H}^+(aq)$ -electrode, where the potential depends on the hydrogen gas pressure which cannot accurately be adjusted without experimental difficulties .

iv. Diffusion potentials (or membrane potentials)

Another means to create an electric potential, without a chemical redox reaction, is based on osmotic pressure and a semipermeable membrane. Let us, for example, assume that two chambers are separated by a semipermeable membrane which only allows the smaller cations of a given salt to permeate, and the left chamber contains a lower concentration of salt in aqueous solution (see fig. 4.10). The difference in osmotic pressure then causes the smaller cations to migrate through the membrane from the right chamber of higher concentration to the left chamber, until the osmotic pressure difference is balanced by the electrostatic interaction, or, in other words, the electrochemical potentials of the cationic species in both chambers are equal.

www.studyat.tudelft.nl

- Ranked #15th in the world (THES Technology ranking 2009)
- Almost 170 years of problem solving experience
- Excellent Sports&Culture facilities
- Check out what and how we teach at www.ocw.tudelft.nl !

TU Delft Delft University of Technology
Challenge the future



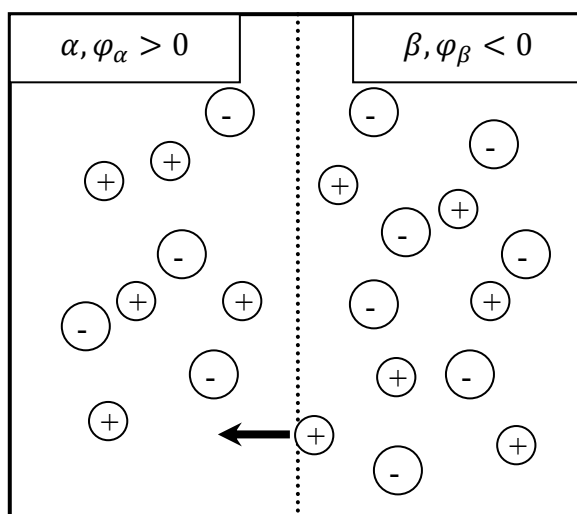

Figure 4.10: Membrane potential

$$\overline{\mu}_\alpha = \mu_\alpha + F \cdot \varphi_\alpha = \overline{\mu}_\beta = \mu_\beta + F \cdot \varphi_\beta \quad (\text{Eq.4.71})$$

$$\Delta\varphi = \varphi_\alpha - \varphi_\beta = \mu_\beta - \mu_\alpha = \frac{RT}{F} \cdot \ln \frac{a_\beta}{a_\alpha} > 0 \quad (\text{Eq.4.72})$$

Note that the concentration is not changing much by the ion migration, and therefore the electric potential difference is given by the ratio of the original salt concentrations. This type of membrane potentials is the basis of our neurons and signal conductivity in our bodies. Semi-permeability of the neurons here is achieved via special proteins embedded within the cellular membrane which are called ion channels.

In this context, one should note that two electrodes are often connected to an electric circuit via a so-called salt bridge, which contains an electrolyte not participating at the redox reaction but just closing the circuit by ion migration. To avoid charge separation and diffusion potentials, which in this case would partially compensate the electrode potential difference (and therefore would lead to a loss in the performance of our chemical battery), the cations and anions of the salt bridge should have identical ion mobilities. This is the case for the salt KCl, which therefore is used in such salt bridges. In the next section, we consider such an electrochemical circuit consisting of two electrochemical electrodes, the Galvanic cell. Fig. 4.11 (see below) shows how the electric circuit is closed in this case by the salt bridge.

4.2.2 The electrochemical Galvanic cell

If you combine two of the chemical electrodes we discussed in the previous section to a closed electric circuit, you obtain a Galvanic chain or electrochemical cell. As an electrochemical battery, this setup is used to convert the chemical energy of a spontaneous redox reaction into electric energy. The spontaneous process can also be reversed by applying an external electric voltage (electrolysis chamber). For the spontaneous process corresponding to a chemical battery, per convention the electrode showing oxidation is placed left, and the electrode showing reduction is placed right. To close the electric circuit, typically a salt bridge containing an aqueous solution of KCl connects the two electrodes or half cells, as already discussed. The Gibbs free enthalpy of the redox reaction of the electrochemical cell, and the electrochemical potential difference (or electromotive force E) of the Galvanic cell are related as (see also definition of ΔG as electric work in chapter 2 !):

$$\Delta_R G = -z \cdot F \cdot E \quad (\text{Eq.4.73})$$

In general, the redox reaction of the cell $Pt(s)/RED_l, OX_l//RED_r, OX_r/Pt(s)$ is given as:



Here RED_l, RED_r , are the reduced species in the left and right part of the Galvanic cell, OX_l, OX_r correspondingly the oxidized species, and $//$ the salt bridge connecting the two chemical electrodes or half cells. The electromotive force of this cell is then given via the difference of the electrode potentials, i.e.

$$E = \Delta\phi_r - \Delta\phi_l = \Delta\phi_r^\ominus + \frac{RT}{zF} \cdot \ln \frac{a_{OX_r}}{a_{RED_r}} - \Delta\phi_l^\ominus + \frac{RT}{zF} \cdot \ln \frac{a_{OX_l}}{a_{RED_l}} = E^\ominus - \frac{RT}{zF} \cdot \ln \frac{a_{RED_r} \cdot a_{OX_l}}{a_{OX_r} \cdot a_{RED_l}} \quad (\text{Eq.4.75})$$

In chemical equilibrium, our Galvanic cell has no electromotive force, and the respective activities of the components of the chemical redox reaction are determined by the chemical equilibrium constant K . Therefore, we obtain

$$E = 0 = E^\ominus - \frac{RT}{zF} \cdot \ln K \quad (\text{Eq.4.76})$$

With the general relation for chemical equilibrium (see Chapter 2, $\Delta_R G^* = -RT \cdot \ln K$ (Eq.2.146)), we finally get:

$$\Delta_R G^* = -z \cdot F \cdot E^\ominus \quad (\text{Eq.4.77})$$

To illustrate the concept of a Galvanic cell, we consider the Danielle-element as a first example of a chemical battery. This Galvanic chain connects a zinc-electrode and a copper electrode via a salt bridge, and therefore is formulated as $Zn(s)/Zn^{2+}(aq)//Cu^{2+}(aq)/Cu(s)$. The cell is sketched in fig. 4.11:

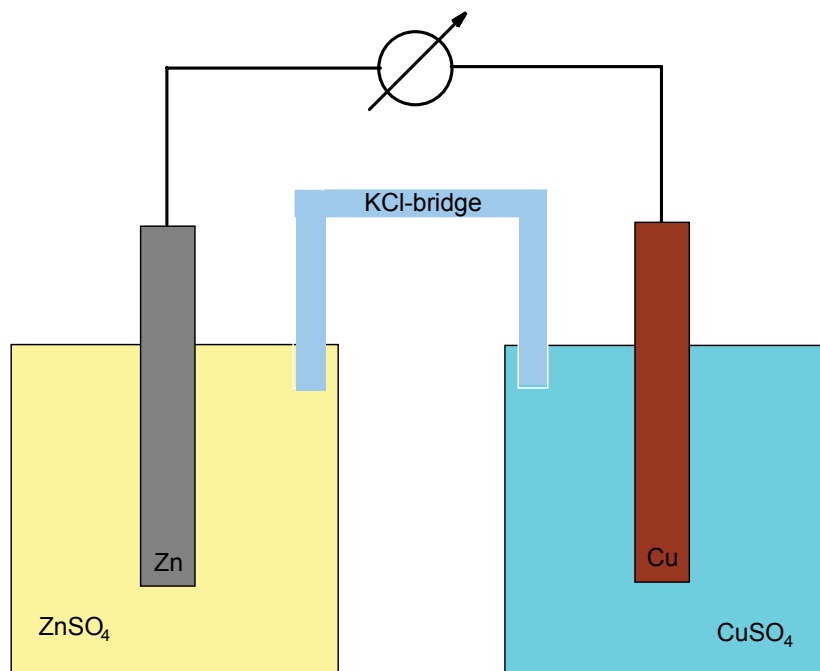

Figure 4.11: Danielle element

"I studied English for 16 years but...
...I finally learned to speak it in just six lessons"
Jane, Chinese architect

ENGLISH OUT THERE

Click to hear me talking before and after my unique course download

In this electrochemical cell, we find the following chemical redox reactions:

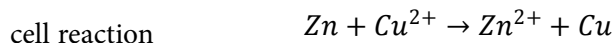

The less noble zinc therefore is oxidized, while the nobler copper is reduced. The electromotive force E of this cell then is then given as:

$$E = \Delta\varphi_{Cu^{2+}/Cu} - \Delta\varphi_{Zn^{2+}/Zn} = \Delta\varphi_{Cu^{2+}/Cu}^{\emptyset} - \Delta\varphi_{Zn^{2+}/Zn}^{\emptyset} - \frac{RT}{2F} \cdot \ln \frac{a_{Zn^{2+}}}{a_{Cu^{2+}}} \quad (\text{Eq.4.77})$$

As a 2nd example, we consider an electrochemical cell where a hydrogen electrode and a silver/silver chloride electrode are immersed in a single chamber containing dilute hydrochloric acid, $Pt(s)/H_2(g)/HCl(aq)/AgCl(s)/Ag(s)$. In this case, we expect the following chemical reactions at the respective electrodes:

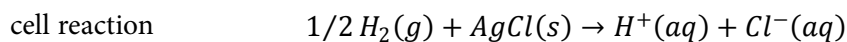
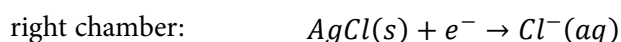
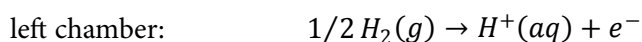

The noble metal silver therefore is reduced, whereas the less noble hydrogen is oxidized. The corresponding electromotive force E of this cell is given as:

$$E = \Delta\varphi_{Cl^-/AgCl/Ag} - \Delta\varphi_{H^+/H_2} = \Delta\varphi_{Cl^-/AgCl/Ag}^{\emptyset} - \Delta\varphi_{H^+/H_2}^{\emptyset} - \frac{RT}{F} \cdot \ln \frac{a_{H^+} \cdot a_{Cl^-}}{f_{H_2}^{0.5}} \quad (\text{Eq.4.78})$$

Since the standard electrode potential of the hydrogen electrode is the basis of the electrochemical potential series and defined as $\Delta\varphi_{H^+/H_2}^{\emptyset} = 0 \text{ V}$, this electromotive force E is simply given as:

$$E = \Delta\varphi_{Cl^-/AgCl/Ag}^{\emptyset} - \frac{RT}{F} \cdot \ln \frac{a_{H^+} \cdot a_{Cl^-}}{f_{H_2}^{0.5}} \quad (\text{Eq.4.79})$$

with $\Delta\varphi_{Cl^-/AgCl/Ag}^{\emptyset} = +0.2223 \text{ V}$.

In practice, electrochemical cells are used in physical chemistry mainly for three different purposes:

- i. determination of the mean ionic activity coefficients f_{\pm} :

Consider for illustration our 2nd example of an electrochemical cell $Pt(s)/H_2(g)/HCl(aq)/AgCl(s)/Ag(s)$. The electromotive force E of this cell can be expressed as:

$$E = \Delta\varphi_{Cl^-/AgCl/Ag}^{\ominus} - \frac{RT}{F} \cdot \ln \frac{a_{H^+} \cdot a_{Cl^-}}{f_{H_2}^{0.5}} \approx \Delta\varphi_{Cl^-/AgCl/Ag}^{\ominus} - \frac{RT}{F} \cdot \ln \frac{m_{H^+} \cdot m_{Cl^-} \cdot f_{\pm}^2}{p_{H_2}^{0.5}} = EMK_{th.} - \frac{2RT}{F} \cdot \ln f_{\pm} \quad (\text{Eq.4.80})$$

$\ln f_{\pm}$ is obtained if you compare the experimentally determined electromotive force E with the theoretically expected value $E_{th.}$ calculated from the standard electrode potential $\Delta\varphi_{Cl^-/AgCl/Ag}^{\ominus}$ and the concentration of the hydrochloric acid (in mole/kg!).

- ii. a second type of application is the electrochemical measurement of pH-values, as discussed before, using a reference electrode and a sensor electrode whose electrode potential depends on the concentration of H^+ .
- iii. more general, one can determine the concentration of many ionic species in aqueous solution if one uses the appropriate chemical electrode. This quantitative analytical method is used, for example, in potentiometric titration, where you monitor the electromotive force E in dependence of added amount of analyte. One example could be the titration of a Fe^{2+} -solution with Ce^{4+} , using a $Cl^-/AgCl/Ag$ -electrode as reference. If the reaction flask is an electrochemical cell containing a Pt -wire, we then formally measure via the electromotive force E the electrode potentials of the following redox electrodes depending on the present species: either $Fe^{2+}(aq), Fe^{3+}(aq)/Pt(s)$ or $Ce^{3+}(aq), Ce^{4+}(aq)/Pt(s)$.

Note that, to accurately determine ion concentrations via measurements of the electromotive force, the electrochemical cell has to be used without any current to avoid electrolytic processes at the electrodes during the measurement, which would change the concentration of interest. In practice, this can be achieved either by compensating the electromotive force E with an external electric potential (so-called Poggendorf compensation), or by using a high resistance within the electric circuit to suppress the charge transport.

Example 4.2:

Consider an electrochemical battery based on two copper electrodes with concentrations $c_{Cu^{2+}} = 1 \text{ Mol/L}$ and $c_{Cu^{2+}} = 1 \cdot 10^{-5} \text{ Mol/L}$. The volume of the electrolyte solution of each electrode is 1 L, and the electric current of this battery is 50 mA. Determine the maximum time this battery will last, and the variation in electric voltage with time.

Solution: This battery is “empty” if the copper ion concentrations in both chambers are equal. In this case, formally about 0.5 Mol of copper ions have been transferred, corresponding to the exchange of 1 Mol electrons. The charge of this Mol electrons is directly given by the Faraday constant, $Q = F = 96484 \text{ C/Mol}$. Therefore, this battery will last for:

$$Q = I \cdot t \quad \Rightarrow \quad t = \frac{Q}{I} = \frac{96484}{0.05} \text{ s} = 1929680 \text{ s} = 22.33 \text{ d}$$

Next, let us calculate the electromotive force E in dependence of time. In general, the voltage of our battery is given as:

$$E = \frac{RT}{2F} \cdot \ln \frac{c_1(Cu^{2+})}{c_2(Cu^{2+})}$$

The concentration changes by the following rate per second:

$$I = \frac{Q}{t} = \frac{0.05 \text{ C}}{1 \text{ s}} = \frac{0.05/F}{1 \text{ s}} \text{ Mol } e^- = \frac{0.025/F}{1 \text{ s}} \text{ Mol } Cu^{2+}$$

, since we need two electrons per copper ion.

Therefore, we obtain the following general expression for the time dependence of the voltage of our battery:

$$E = \frac{RT}{2F} \cdot \ln \frac{c_1(Cu^{2+})}{c_2(Cu^{2+})} = \frac{RT}{2F} \cdot \ln \frac{1 - \frac{0.025}{F}t}{10^{-5} + \frac{0.025}{F}t}$$

The following table gives us an impression how rapidly the voltage decays:

Time/ s	0	1800	3600	7200	18000	36000
Voltage/ V	0.145	0.0966	0.0879	0.0792	0.0677	0.0589

Note that, although this battery will last for more than 20 days, the voltage has reached 50% after less than 5 hours (18000 s, see table)! The performance can be strongly enhanced, i.e. the voltage kept nearly constant and the maximum duration doubled, if one “catches” the copper ions released in the chamber of lower copper ion concentration either by complexation or by precipitation.

We conclude our chapter on electrochemistry by presenting the chemical redox reactions for some of the technically most important electrochemical batteries:

i. lead accumulator

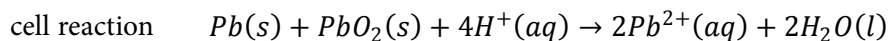
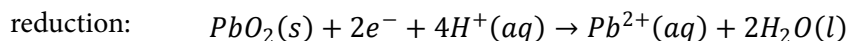
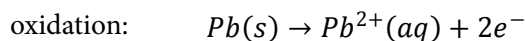

This cell reaction underlines the importance of the pH of the sulfuric acid for the performance of the lead accumulator!

ii. Ni-Cd-accumulator

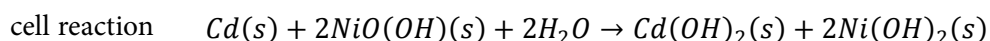
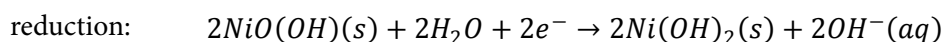
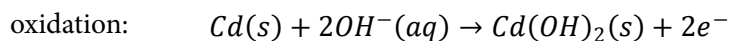

Study at one of Europe's leading universities



DTU, Technical University of Denmark, is ranked as one of the best technical universities in Europe, and offers internationally recognised Master of Science degrees in 39 English-taught programmes.

DTU offers a unique environment where students have hands-on access to cutting edge facilities and work

closely under the expert supervision of top international researchers.

DTU's central campus is located just north of Copenhagen and life at the University is engaging and vibrant. At DTU, we ensure that your goals and ambitions are met. Tuition is free for EU/EEA citizens.

Visit us at www.dtu.dk



5 Introduction to Quantum Chemistry and Spectroscopy

In this chapter, I will try to briefly introduce the concept of quantum chemistry, which is essential to understand spectroscopic methods, an analytical tool extremely important in chemistry. Some common spectroscopic techniques will therefore also be addressed in this chapter. Note that this chapter can serve as a rather superficial introduction to quantum chemistry only: especially, I refer from any detailed mathematical representation of the topic for the reason of readability (and lack of space), and the quantum chemical concept of the chemical bond is also not treated here.

5.1 Models of the atom

Historically, our picture for the nature of matter developed from the rather philosophical description of the ancient Greeks (atoms = simple small geometrically different objects, like cubes, spheres etc.), via Bohr's model of negative charges migrating on concentric circles around a positively charged nucleus like planets orbiting the sun, finally to a new physical interpretation called quantum mechanics. Let us briefly repeat the most important historic steps of this development:

Demokrit, 5th century BC, stated that atoms (from Greek: $\alpha\theta\omicron\mu\omicron\sigma$ = inseparable) are the smallest parts of any matter, and differ in geometrical shape and color. It took a very long time until Dalton, in the 19th century, interpreted the law of constant proportions to the conclusion that some matter consists of small groups of different atoms, called molecules. For example, the smallest parts of the substance water are molecules which consist of 2 atoms of hydrogen and 1 atom of oxygen.

From the late 19th century, our atomic models changed comparatively rapidly, i.e. within several decades, based on new experimental results. This underlines the importance of the actual method of scientific research: develop any model only based on experimental results, as well as check existing models based on their predictions of experimental results! First, the discovery of the negatively charged electron within the cathode-radiation, and the experimental prove of its particular character within the Wilson cloud chamber (see fig. 5.1), lead to the Thomson model visualizing atoms analogous to a cake, where the negative charges are embedded like resins within a positively-charged lump of comparatively low mass density (see fig. 5.2) (Thomson 1897).

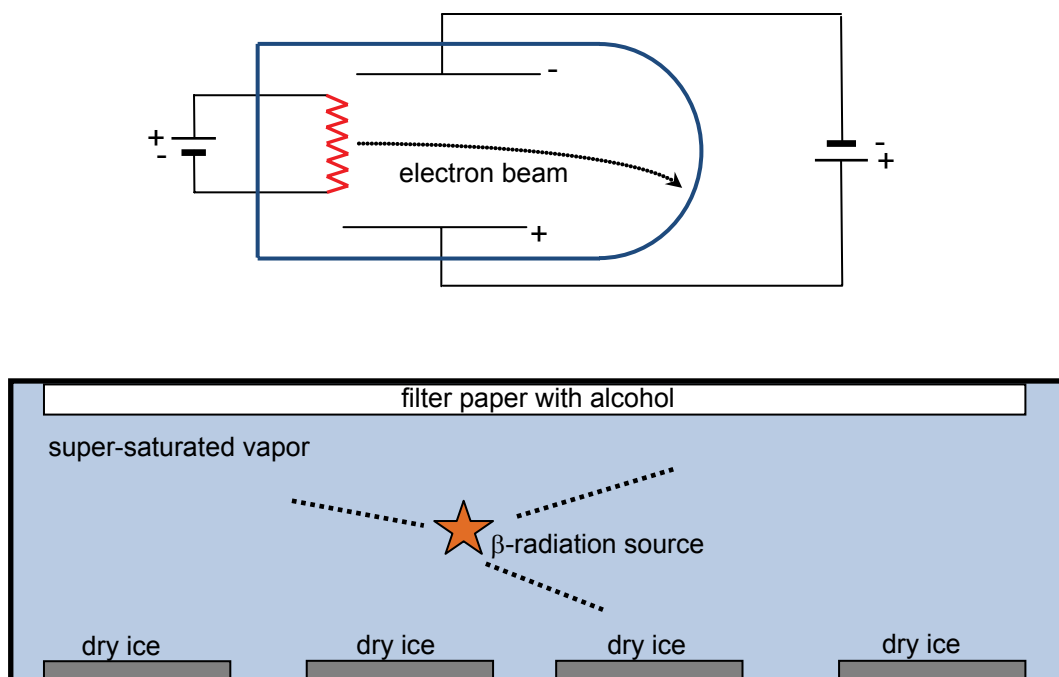

Figure 5.1: Cathode radiation and deviation of the electron beam in an electric field proving the negative charge of electrons (top), and proof of its particular character (a β -source emits electrons!) via the Wilson cloud chamber (bottom)

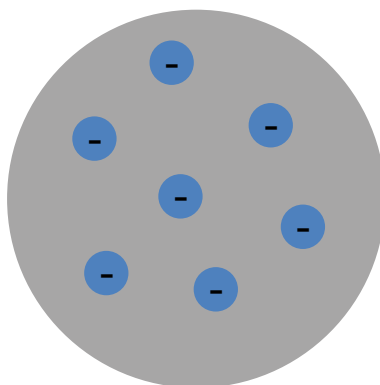

Figure 5.2: The Thomson model of the atom (electrons like “resins in a cake”). Note that the “cake” itself (grey area) is positively charged to compensate for the electrons charge, since the atom itself is charge-neutral.

Based on the low mass density of the atoms as well as the small size of the electrons, according to the Thomson-model one would expect that, if you direct a ray of small positive charges called α -radiation (= He^{2+} -ions) onto a thin foil of gold atoms, the projectiles should pass through the foil more or less unhindered (Geiger and Marsden experiment, 1909). Although this was true for most of the α -particles, the experiment also showed that a small fraction of the projectiles was reflected by the atoms of the gold foil (see fig. 5.3). This was in contradiction with the Thomson model, and led to a new model suggested by Rutherford, who postulated that the positive charge of the atom should be allocated within the center of the atoms within a tiny highly massive core (see fig. 5.3).

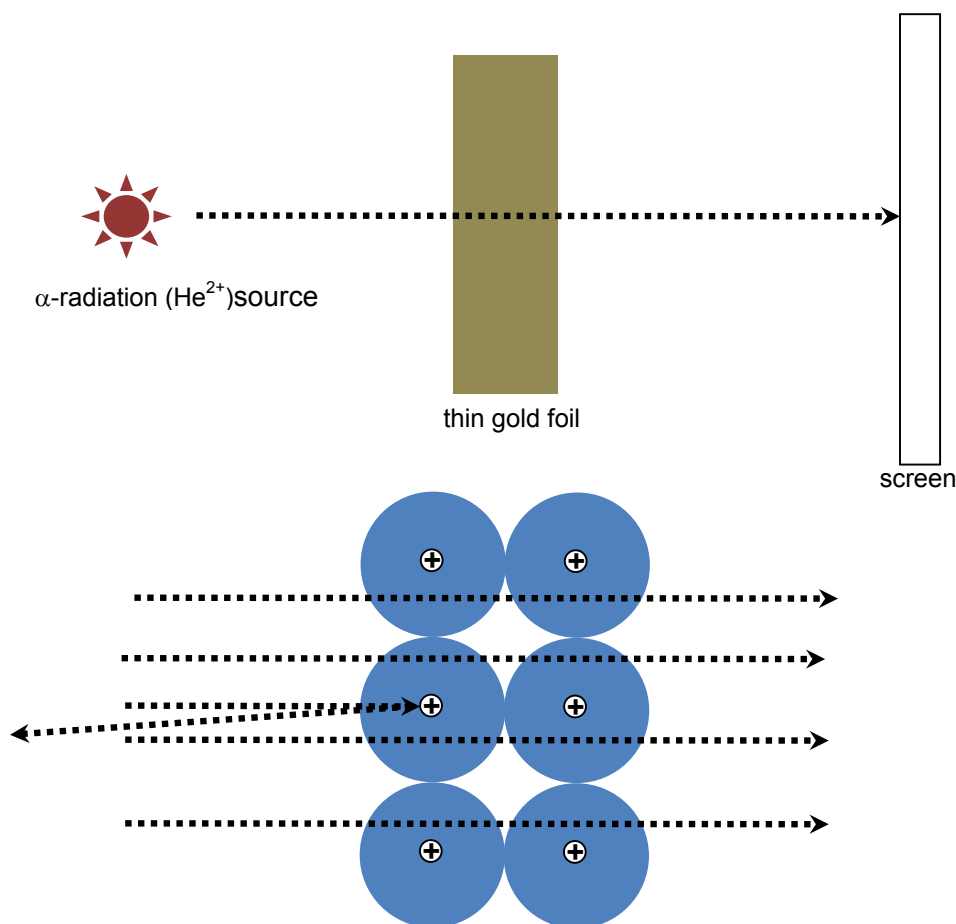

Figure 5.3: Geiger-Marsden experiment (top), and interpretation of the experimental results via a new atomic model suggested by Rutherford (bottom).

The problem of the new Rutherford model was to explain why the negatively charged electrons obviously are not collapsing into the positively charged atomic core, i.e. what keeps the volume of the atom stable, since the atom should mainly consist of “nothing” as proven by the fact that most of the α -projectiles in the Geiger and Marsden experiment passed through the gold foil unhindered. Another experimental finding not explained by the Rutherford model are spectroscopic measurements showing that atoms absorb light of specific wave lengths only. Niels Bohr therefore suggested in 1913 a new atomic model to explain the spectroscopic observations.

If we assume that the absorption of light changes the state of the electrons, we may conclude that an electron bound within an atom only assumes certain levels of energy. Bohr developed a new model still based on classical physics, which postulated that the electrons are moving with constant velocity v around the positively charged core of the atom on stable circular orbits of radius r , like planets moving around the sun. In this case, the Coulomb attraction between the electrons and the core is compensated by the centrifugal force:

$$F_{Coulomb} = -\frac{e^2}{(4\pi\epsilon_0)r^2} = -F_{centr.} = -\frac{m \cdot v^2}{r} \quad (\text{Eq.5.1})$$

The kinetic energy of these moving electrons is then given as $E_{kin} = 1/2 \cdot m \cdot v^2$. Note that, according to the Maxwell equations, such an electron moving within the electric field originating from the positively charged atomic core should lead to the continuous radiation of an electromagnetic field. As a consequence, the electron would also continuously lose some of its kinetic energy, which finally should lead to the collapse of the atom. Bohr “solved” this problem, and thereby also provided an explanation for the experimental results from spectroscopy that an electron bound to an atom only assumes specific energies (or specific orbits), by postulating that the electron is confined to specific orbits r_n fulfilling the following relation concerning their rotational momentum:

$$|\vec{l}| = |\vec{r} \times \vec{p}| = m \cdot v \cdot r_n = n \cdot \frac{h}{2\pi} \quad (\text{Eq.5.2})$$

with n an integer (1, 2, 3, ...), and $h = 6.626 \cdot 10^{-34} \text{ J} \cdot \text{s}$ Planck's constant. With this boundary condition, you obtain the following allowed values for the energy of the electron encircling the core of the hydrogen atom, i.e. charge = +1e:

$$E_n = -\frac{m_e \cdot e^4}{(4\pi\epsilon_0)^2 \cdot 2 \cdot (h/(2\pi))^2} \cdot \frac{1}{n^2}, \quad n = 1, 2, 3, \dots \quad (\text{Eq.5.3})$$

m_e is the mass of the electron, $9.109 \cdot 10^{-31} \text{ kg}$. The energy difference between two of these orbits, and therefore the frequency of light necessary to lift an electron from one inner orbit to a larger one of higher energy, then is given as:

$$\Delta E = E_{n_2} - E_{n_1} = -\frac{m_e \cdot e^4}{(4\pi\epsilon_0)^2 \cdot 2 \cdot (h/(2\pi))^2} \cdot \left(\frac{1}{n_2^2} - \frac{1}{n_1^2} \right) = h \cdot \nu \quad (\text{Eq.5.4})$$

Note that, if the electron is lifted to defined energetically excited states by, for example, external electrical energy (see for example gas lamps), it will go back to its original energetic state while emitting light of specific wavelengths, corresponding in energy to the differences given by Eq.5.4 (emission spectrum of atoms, see fig. 5.4).

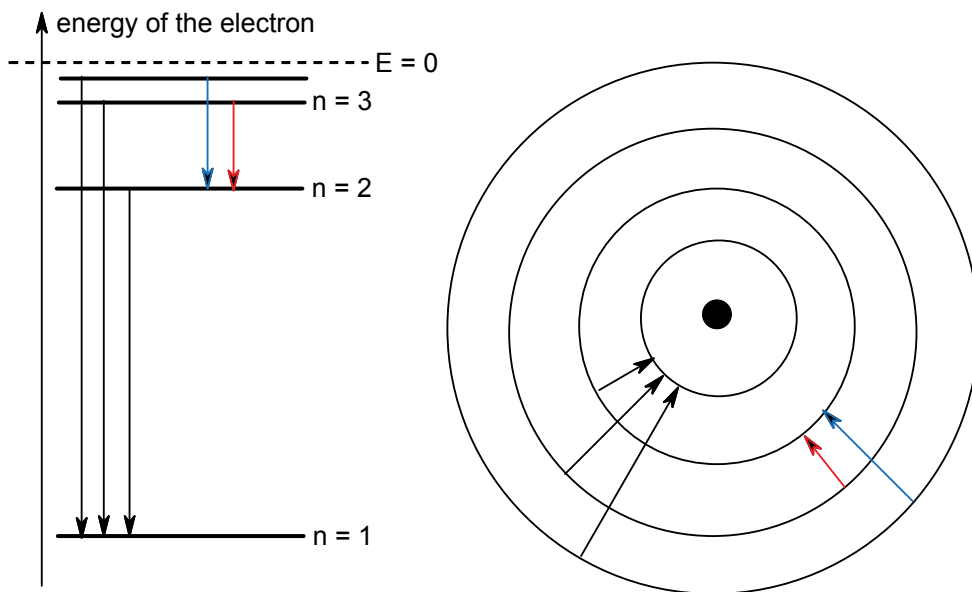

Figure 5.4: Energetic transitions responsible for the hydrogen emission spectrum, and the Bohr atomic model (red, blue arrows indicating the Balmer-series found in the visible regime of the electromagnetic spectrum)



MSM

MAASTRICHT SCHOOL OF MANAGEMENT

Increase your impact with MSM Executive Education





For almost 60 years Maastricht School of Management has been enhancing the management capacity of professionals and organizations around the world through state-of-the-art management education.

Our broad range of Open Enrollment Executive Programs offers you a unique interactive, stimulating and multicultural learning experience.

Be prepared for tomorrow’s management challenges and apply today.

For more information, visit www.msm.nl or contact us at +31 43 38 70 808 or via admissions@msm.nl

the globally networked management school



Emission (or absorption, see further below) spectroscopy therefore can be used to quantitatively measure the differences of the discrete energetic states of atoms (or molecules, see below). Bohr could show that quantum physics, a new concept introduced first by Plack (1900) and Einstein (1905), and classical physics are in agreement at large quantum numbers n (principle of correspondence). However, at small quantum numbers Bohr encountered certain difficulties to match his model onto experimental observations on a sound mathematical and physical basis. This problem could only be resolved by a completely new theoretical approach, modern quantum mechanics.

Before we approach the concept of quantum mechanics (which was formulated in the mid-1920s by Werner Heisenberg, Max Born and Pascual Jordan (matrix mechanics), Louis de Broglie and Erwin Schrödinger (wave mechanics)), let us briefly sketch the nature of light as it is described within the classical physical model. Classically, light was considered as an electro-magnetic wave quantitatively described by the Maxwell equations and migrating with light's speed ($c = 3 \cdot 10^8 \text{ m/s}$). The oscillating electric field amplitude vector of light of wavelength λ migrating, for example, in x -direction, is given as:

$$\vec{E}(x, t) = \vec{E}_0 \cdot \cos\left(\frac{2\pi x}{\lambda} - \frac{2\pi c}{\lambda} \cdot t\right) \quad (\text{Eq.5.5})$$

The electric field amplitude is showing periodic oscillations both as a function of space and time, and the oscillation frequency is given by the light velocity and the wave length as:

$$\nu = \frac{c}{\lambda} \quad (\text{Eq.5.6})$$

To conclude this section, note that at this stage of our description of the atom still based on classical physics, we encounter at least two fundamental problems: first, there is no physical reason why an electron should be limited to specific orbits only (early quantum theory postulated by Niels Bohr). Second, within the classical physical picture the moving electron should loose energy and therefore collapse into the atomic core, as already mentioned above. As we will show in the next section, a new concept of physics, modern quantum mechanics, is necessary to solve our problem. Interestingly, this new concept is also relevant in respect to the nature of light: classically, as we have just described, light is an electromagnetic wave. However, Einstein has discovered in 1905 in his famous publication explaining the photoelectric effect that light also must have a particle character. To resolve these problems, a new concept of physics was introduced in the 1920s (Heisenberg, Schrödinger, 1925), quantum mechanics, which attributes a wave character to everything, even solid matter.

5.2 The wave character of matter, or the wave-particle-dualism

Analogous to water waves, in some experiments small moving particles also show diffraction phenomena typical for a wave character. The general wave equation describes a harmonic oscillation of a physical quantity $\Psi(x, t)$ with space and time, i.e.

$$\Psi(x, t) = \Psi_0 \cdot \sin\left(\frac{2\pi x}{\lambda} - \frac{2\pi t}{\tau}\right) \quad (\text{Eq.5.7})$$

In eq.5.7., Ψ_0 is the amplitude or maximum value of our physical quantity, λ the wavelength and τ the duration of one oscillation. If a circular wave, for instance light, is passing through two neighboring slits of adequate separation and size, these slits act as origins of two new circular waves with well-defined phase difference, and a screen behind the slits shows a regular interference pattern of dark and bright stripes (see fig. 5.5). On the other hand, if a beam of light is shining through a single small slit the screen does not simply show a sharp image of the slit, but also light of lower intensity on the edges, which looks as if the light is partially twisted while passing through the slit (= diffraction).

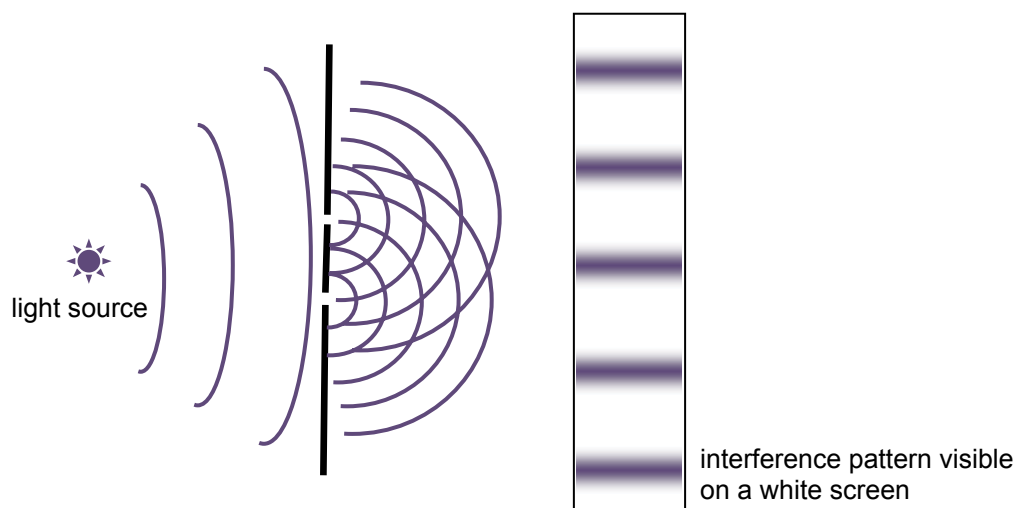

Figure 5.5: Diffraction of light wave on a two-slit setup

Diffraction and interference are experimental phenomena proving the wave character of light.

However, there exist experimental results which can only be interpreted if light is consisting of individual particles called photons, the photo-electric effect discussed 1905 by Albert Einstein. The photoelectric effect is the experimental result that electrons released from metal by incident light are assuming a kinetic energy (or velocity) independent of the light amplitude, but only dependent on the wavelength of light. On the other hand, the number of released electrons increases proportional to an increase of the power (or amplitude) of the light. These results can only be understood if one single light particle (= photon) releases one single electron, and the energy of the electron is depending on the energy of this photon, which itself depends on the wavelength or frequency of light. The number of released electrons then depends on the number of incident photons, which is given by both the power of light and the frequency. The energy of a single photon is given as:

$$E = h \cdot \nu = h \cdot \frac{c}{\lambda} \quad (\text{Eq.5.8})$$

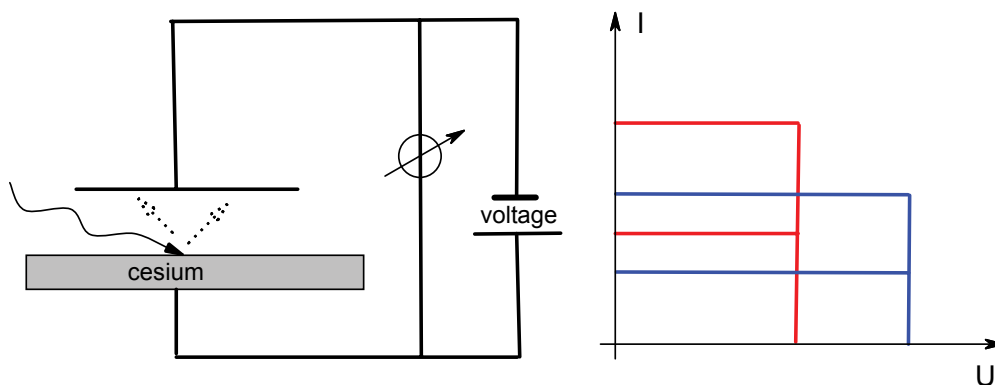

Figure 5.6: The photoelectric effect, experimental setup (left) and resulting photo electric current (right)

The experiment itself, as sketched in figure 5.6, works as follows: the electrons, released by incident light, are kept in the cesium plate if their energy is too low to migrate to the counter electrode which is kept at an adjustable electric potential (or voltage). Thereby, this potential provides a direct experimental measure for the energy of the photoelectrons, whereas a measurement of the electric current at lower potentials provides a measure for the number of released electrons. In this experimental setup, the wavelength and power of the incident light are varied, and the electric current in dependence of the voltage is measured. The electric current divided by the elementary charge then directly corresponds to the number of incident photons per second, whereas the electrostatic energy $e \cdot U$ plus the ionization energy of the metal per atom, typically cesium, corresponds to the energy of a single photon.

gaieteye
Challenge the way we run

EXPERIENCE THE POWER OF FULL ENGAGEMENT...

.....

**RUN FASTER.
RUN LONGER..
RUN EASIER...**

**READ MORE & PRE-ORDER TODAY
WWW.GAITEYE.COM**

In conclusion, light behaves, depending on the experiment, like a wave or a particle, a phenomenon which is called wave-particle-dualism. This behavior is also found for objects which in classical physics typically were regarded as particles, like electrons or even particles of much larger masses. Davisson and Germer (1927), for example, showed that an electron beam hitting a small gold foil or a nickel crystal in reflection, that is, a periodic lattice on an atomic length scale, shows interference phenomena.

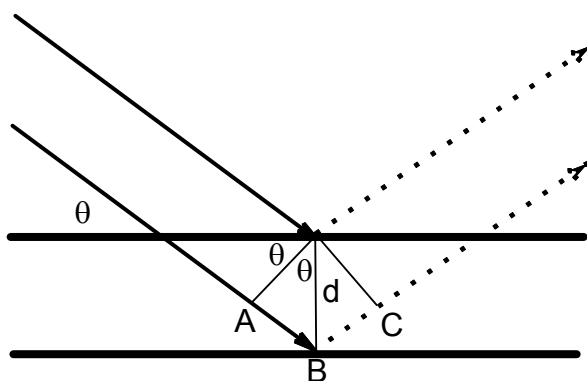

Figure 5.7: Diffraction of an electron beam – the Davisson-Germer experiment and Bragg diffraction

The Davisson-Germer experiment can be explained by the constructive interference of two electron waves reflected at the outermost atom layer and an inner layer of the nickel crystal, respectively. The inner reflected beam migrates a longer distance, and constructive interference occurs if this longer distance is a multiple of the light wavelength, leading to the famous Bragg law of diffraction (see fig. 5.7 and Eq.5.9):

$$n \cdot \lambda = 2d \cdot \sin \theta \quad (\text{Eq.5.9})$$

So far, we have learned that, depending on the actual experimental observation, light or even matter either exhibits particle or wave character. This fundamental problem of the wave-particle dualism can be resolved if we introduce the concept of standing waves. For example, an electron migrating around an atomic nucleus on a stable orbit can be regarded as a resonant standing wave, like the strands of a guitar. Note that for one-dimensional standing waves the amplitude at the edges have to be zero, limiting the allowed wave lengths (see fig. 5.8), and therefore leading to discrete energy levels or quantization of energy, as we have seen already in the Bohr model, where classical physics could provide no satisfactory explanation for the quantization.

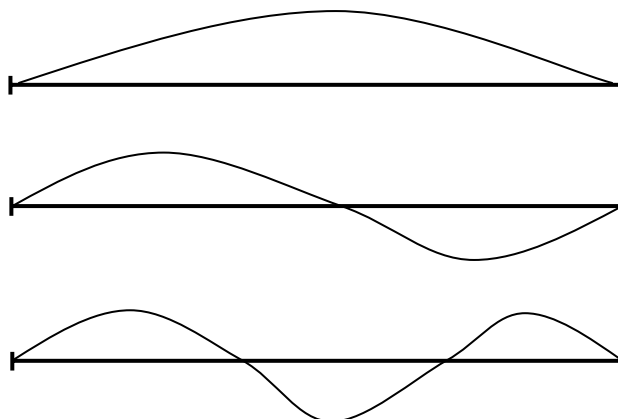

Figure 5.8: 1-dimensional standing waves

The description of very small particles as a standing wave will lead us directly to the mentioned new concept of physics, quantum mechanics. For a particle which is more or less localized, we usually have to use not a single standing wave but packages of interfering waves. These wave packages provide an explanation of Heisenberg's relation $\Delta p_x \cdot \Delta x \geq \hbar$, i.e. it is not possible to simultaneously determine the momentum p_x and the position x of any moving object with a (combined) accuracy $\Delta p_x \cdot \Delta x < \hbar$! Another important aspect of the wave description of moving particles is the de-Broglie equation:

$$p = h/\lambda \quad (\text{Eq.5.10})$$

This important equation relates the momentum p (= particle quality) to the wavelength λ (= wave quality), and therefore providing an excellent conclusion to the wave-particle dualism. Here, it should be noted that especially for particles moving with velocities close to the speed of light c , the momentum has to be calculated in a relativistic manner, i.e.

$$p = \frac{m \cdot v}{\sqrt{1 - \left(\frac{v}{c}\right)^2}} \quad (\text{Eq.5.11})$$

Note here that for photons of mass zero, we then get formally $= 0/0$! However, from the general de Broglie equation (Eq.5.10.) we know that also for the photon $p = h/\lambda$!

Let us go back to Heisenberg's uncertainty principle: as the two extreme cases, one can either determine exactly the momentum p_x or the position x , and correspondingly the position or the momentum have to be totally undefined (see fig. 5.9): in the first case, the moving particle is described as a single standing wave of given wavelength (or wave vector of magnitude $k = 1/\lambda$), and therefore its momentum is exactly defined by the de-Broglie equation, whereas the position is totally undefined. In the second case, the position is exactly defined, and correspondingly the wavelength or momentum of the particle is totally undefined. In most cases, both momentum and position are defined within a finite uncertainty. In this case, as mentioned above, a wave package with wavelengths within a certain interval is necessary to describe our moving particle.

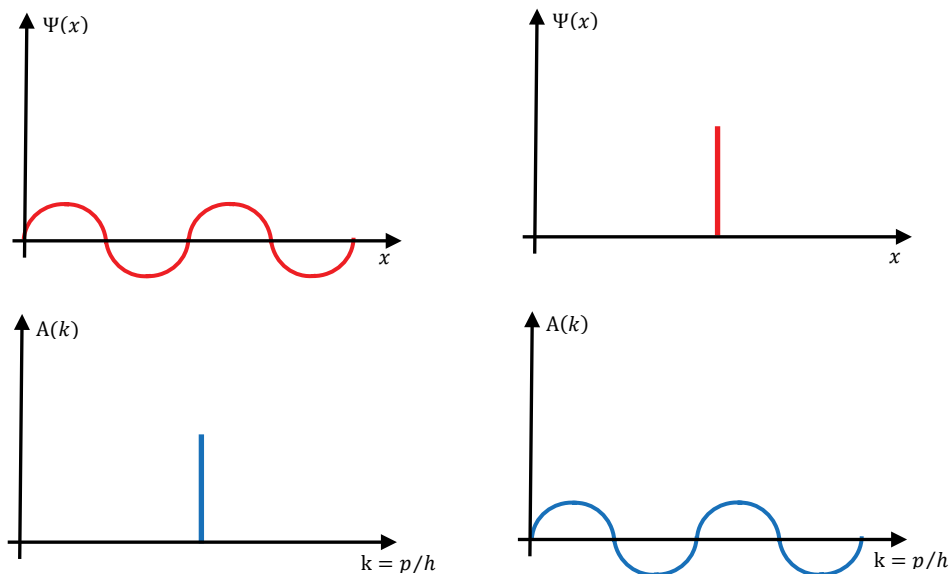

Figure 5.9: The Heisenberg uncertainty principle – the two extreme cases (either momentum (left) or position (right) are exactly defined)

DESTINATIONS

		GATE	ARRIVAL
INDUSTRY	IMPACT	OW	FASTER
GLOBAL	ASSIGNMENTS	OW	FASTER
SENIOR	CLIENT CONTACT	OW	FASTER
CAREER	DEVELOPMENT	OW	FASTER
MAKE	PARTNER	OW	FASTER

OLIVER WYMAN



Oliver Wyman is a leading global management consulting firm that combines deep industry knowledge with specialized expertise in strategy, operations, risk management, organizational transformation, and leadership development. With offices in 50+ cities across 25 countries, Oliver Wyman works with the CEOs and executive teams of Global 1000 companies.
An equal opportunity employer.

GET THERE FASTER

Some people know precisely where they want to go. Others seek the adventure of discovering uncharted territory. Whatever you want your professional journey to be, you'll find what you're looking for at Oliver Wyman.

Discover the world of Oliver Wyman at oliverwyman.com/careers



Example 5.1:

Calculate the wave lengths for the following cases: (i) neutrons thermally excited at $T = 500$ K, (ii) electrons accelerated by a voltage of 50 kV

Solution:

We use the de-Broglie relation, $\lambda = \frac{h}{p}$, and determine the momentum via the respective kinetic energies, $E_{kin} = \frac{1}{2}mv^2 = \frac{p^2}{2m}$, which have to be identical to the thermal energy (case (i)) or the electrostatic energy (case (ii)), respectively.

(i) For the thermal excitation of the neutrons, we find

$$\frac{p^2}{2m} = \frac{3}{2}kT \quad \Rightarrow$$

$$p = \sqrt{\frac{3}{2}kT \cdot 2m} = \sqrt{\frac{3}{2} \cdot 1.38 \cdot 10^{-23} \cdot 500 \cdot 2 \cdot \frac{0.001 \text{ J}\cdot\text{s}}{6 \cdot 10^{23} \text{ m}}} = 5.874 \cdot 10^{-24} \frac{\text{J}\cdot\text{s}}{\text{m}}$$

$$\Rightarrow \quad \lambda = \frac{h}{p} = \frac{6.626 \cdot 10^{-34}}{5.874 \cdot 10^{-24}} \text{ m} = 1.128 \cdot 10^{-10} \text{ m} = 0.113 \text{ nm}$$

(ii) For the electrons, we find

$$\frac{p^2}{2m} = e \cdot U \quad \Rightarrow$$

$$p = \sqrt{e \cdot U \cdot 2m} = \sqrt{1.6 \cdot 10^{-19} \cdot 50000 \cdot 2 \cdot 9.109 \cdot 10^{-31} \frac{\text{J}\cdot\text{s}}{\text{m}}} = 1.207 \cdot 10^{-22} \frac{\text{J}\cdot\text{s}}{\text{m}}$$

$$\Rightarrow \quad \lambda = \frac{h}{p} = \frac{6.626 \cdot 10^{-34}}{1.207 \cdot 10^{-22}} \text{ m} = 5.490 \cdot 10^{-12} \text{ m} = 0.005 \text{ nm}$$

The very small wave length of the electron corresponds to the atomic resolution of the electron microscope. On the other hand, neutrons with wave length comparable to the length of chemical bonds are used for example to explore the molecular structure of nanoparticles and polymer chains by so-called neutron scattering experiments.

We continue with the mathematical solutions of some fundamental problems of quantum mechanics in the next section.

5.3 Mathematical solutions of some simple problems in quantum mechanics: particle in a box, harmonic oscillator, rotator and the hydrogen atom

The basis to mathematically solve quantum mechanical problems is the Schrödinger-equation

$$\hat{H}\Psi(x) = E \cdot \Psi(x) \quad (\text{Eq.5.12})$$

with the Hamilton operator, $\Psi(x)$ the wave function describing the probability (given as $|\Psi(x)|^2$ see Eq.5.12) to find a particle or system at position dx , and E the discrete energy values the system may assume. Here, it should be noted that at very high energies, the regime of classical physics is reached where the spectrum of energies a system may assume is a continuum. The operator \hat{H} is derived from classical physical expressions for kinetic and potential energy following a comparatively simple procedure, which will not be discussed in detail in this book. Note that in mathematics any “operator” operates on the function written behind it, e.g., the differential operator d/dx operates on a function $f(x)$ ($d/dx f(x)$). We will limit our treatment of quantum chemistry instead to the presentation and brief discussion of the quantum chemical results for $\Psi(x)$ and E for the most fundamental simple models. A very important result of the Schrödinger equation is the quantization of energy, which already can be understood qualitative from the concept of standing waves (see section 5.2). Note that the wave functions $\Psi(x)$ can assume positive, negative or even complex numbers. Therefore, the probability to find a system at position x , which has to be a real number, is generally defined as

$$\Psi(x) \cdot \Psi(x)^* = |\Psi(x)|^2 \quad (\text{Eq.5.13})$$

(i) Our first example is the particle in a box. This model describes any moving particle of mass m limited to a very small defined volume by infinitely high potential energy barriers. Within these barriers, the particle has only kinetic energy. The potential energy therefore has only the effect to restrict the particle position. This fundamental simple model can be used, for example, to explain the change in light absorption wavelengths of aromatic molecules from benzene to anthracene (see fig. 5.10): in this case, the moving particles are the π -electrons, and the box dimensions are defined by the size of the respective molecule. The larger the molecule or the larger the box, the longer the wavelengths of the standing waves to describe the position of the electrons within the box. Consequently, to lift an electron from its ground state to an excited state by the absorption of light, a photon of lower energy or larger wavelength is needed the larger the molecule. Therefore, from benzene to anthracene the absorption maximum shifts to larger wavelengths (or, considering colors within the spectral regime, from UV to blue).

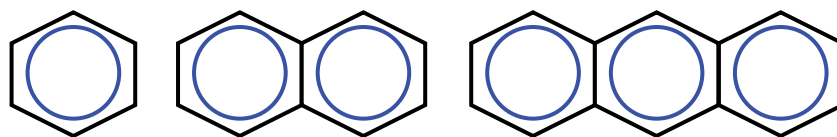

Figure 5.10: Particle in a box model and the π -electron system in condensed aromatic rings. The “box dimension” increases from benzene (left) to anthracene (right), and accordingly the absorption spectrum is red-shifted.

In case the potential barrier is infinitely high, the probability to find the particle at each wall is zero, and $\Psi(x)$ is given by a perfect standing wave (or sine-, cosine-function). With decreasing wavelength, the energy increases, since, according to classical physics and the de-Broglie equation (Eq.5.10.), the kinetic energy is given as:

$$E = \frac{1}{2}mv^2 = \frac{p^2}{2m} = \frac{h^2/\lambda^2}{2m} \quad (\text{Eq.5.14})$$

Since for our particle in a box the wavelengths from the ground state to the excited states decrease as 1, 1/2, 1/3, ..., we expect the energy levels to scale as 1, 4, 9, ..., even without exactly solving the Schrödinger equation. The wave functions $\Psi(x)$ and the corresponding E - eigenvalues are given in figure 5.11:



Day one
and you're ready

Day one. It's the moment you've been waiting for. When you prove your worth, meet new challenges, and go looking for the next one. It's when your dreams take shape. And your expectations can be exceeded. From the day you join us, we're committed to helping you achieve your potential. So, whether your career lies in assurance, tax, transaction, advisory or core business services, shouldn't your day one be at Ernst & Young?

What's next for your future?
ey.com/careers

ERNST & YOUNG
Quality In Everything We Do

© 2010 EYGM Limited. All Rights Reserved.

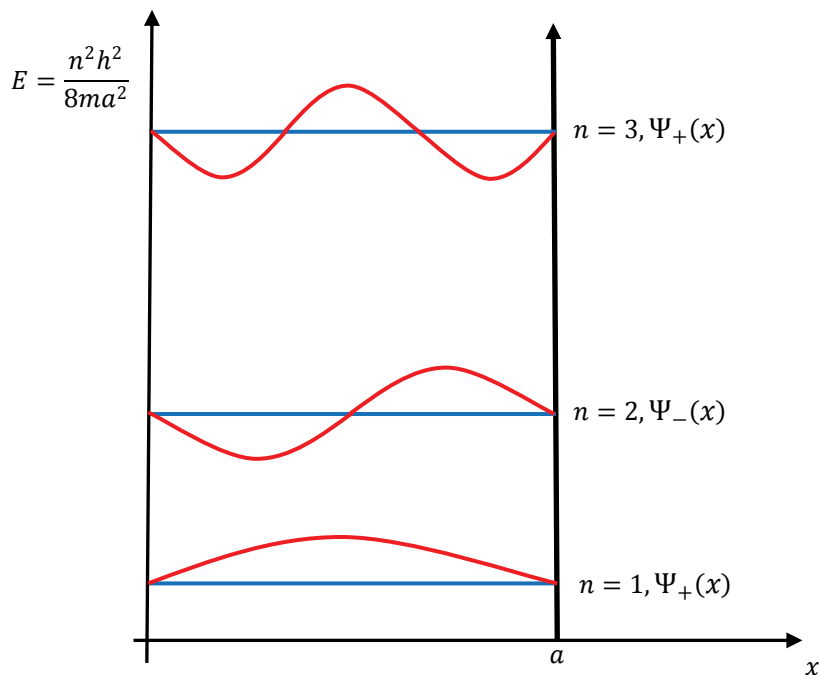

Figure 5.11: wave functions and energy Eigenvalues of 1-dimensional particle in a box-problem

Here, + and – define the symmetry of the wave function in respect to the center of the box: + is symmetric, – antimetric.

According to the respective changes in wavelength of the standing waves within the box with increasing quantum number (see above), the energies depend on an integrate quantum number $E_n \sim n^2$, $n = 1, 2, \dots$. Note that the lowest energy level is not zero, which is obvious from fig. 5.11 since the corresponding wave function has a finite wavelength. This finite energy of the ground state is also in agreement with the Heisenberg relation, since zero energy would correspond to an exactly defined momentum. In combination with a particle position limited within the box, this would, in violation of the Heisenberg uncertainty relation, lead to $\Delta p_x \cdot \Delta x = 0$.

For a 3-dimensional box, the energy levels depend on a set of three independent quantum numbers, the particle mass, and the box size, as:

$$E_{n_x, n_y, n_z} = \frac{h^2}{8 \cdot m \cdot a^2} \cdot (n_x^2 + n_y^2 + n_z^2) \quad (\text{Eq.5.15})$$

Consequently, there exist different sets of quantum numbers with identical energy levels, for example $E_{1,1,2} = E_{1,2,1} = E_{2,1,1}$. This phenomenon, called degenerate energy levels, is, for example, also found for the p-orbitals of an electron orbiting the hydrogen nucleus, as we will see later.

Finally, if the potential walls of our box are not of infinite energetic height, there exists a finite probability for the particle to exist outside the box or pass through the wall even if its kinetic energy is still much lower than the potential barrier. Note also that in this case the wave function no longer is a simple standing wave (simple sine- or cosine-function, see fig. 5.11), but approaches asymptotically 0 beyond the walls of the box (see fig. 5.12). This phenomenon is called tunneling, another effect besides energy quantization and Heisenberg's uncertainty principle not encountered in classical physics.

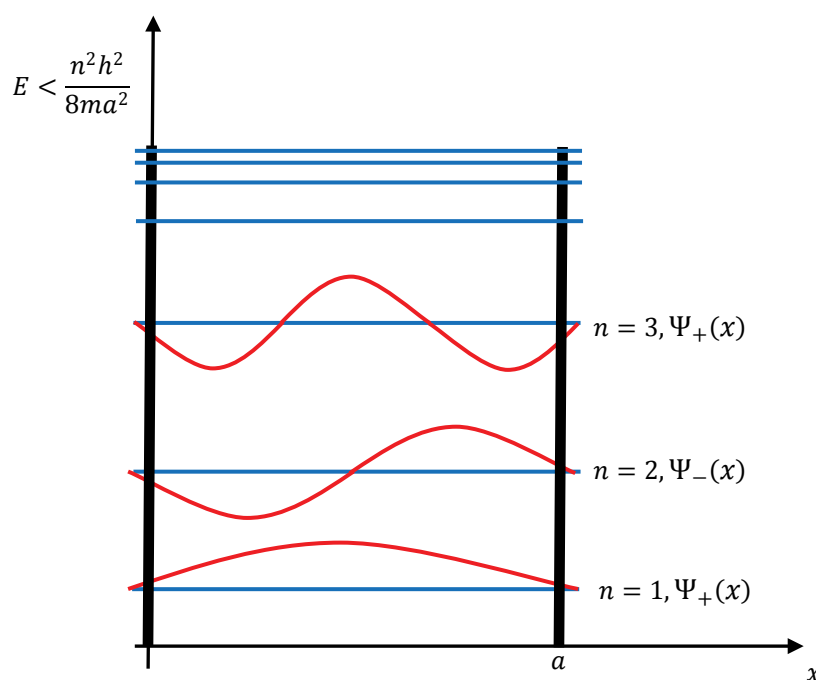

Figure 5.12: particle in a box with finite potential barrier. Note that approaching the barrier the energy levels are coming closer. Above the barrier, quantization of energy is no longer found but any energy value is physically possible (energetic continuum)

Formally, the simple model of a particle in a box already leads to some features also found in the more complex hydrogen atom. In both cases, the spatial location of a moving particle is limited by a potential energy barrier, leading to such general features as energy quantization, or energetically degenerated states if the box is 3-dimensional. In addition, the shape of the wave functions already reminds one of electron orbitals: the totally symmetric wave function $\Psi_{1,1,1}(x, y, z)$, for example, represents an 1s-orbital in shape, whereas the degenerate axially antimetric wave functions $\Psi_{2,1,1}(x, y, z)$, $\Psi_{1,2,1}(x, y, z)$ or $\Psi_{1,1,2}(x, y, z)$ correspond in shape to $2p_x$ -, $2p_y$ - or $2p_z$ -orbitals, respectively. The more complex wave function $\Psi_{2,2,1}(x, y, z)$ finally looks similar to a $3d_{xy}$ -orbital.

(ii) Our second example is the so-called harmonic oscillator, important to determine the energy levels of the oscillations of chemical bonds within molecules. Like in a simple spring model, where the force pulling back the spring is described by Hooke's law ($F = -kx$, with k the spring constant), the potential energy of this system is given as:

$$V = -\int F dx = \frac{1}{2} kx^2 \quad (\text{Eq.5.16})$$

The Schrödinger equation yields the following solutions for the discrete energy levels:

$$E_v = h \cdot \nu_0 \cdot \left(v + \frac{1}{2}\right), \quad v = 0, 1, 2, \dots \quad (\text{Eq.5.17})$$

with basic oscillation frequency ν_0 depending on the spring constant and the moving mass as

$$\nu_0 = \sqrt{\frac{k}{m}} \quad (\text{Eq.5.18})$$

For a simple molecule consisting of two atoms only, k corresponds to the stiffness (or force constant) of the chemical bond, whereas the mass is the so-called reduced mass defined as (see fig. 5.14):

$$m = \frac{m_1 \cdot m_2}{m_1 + m_2} \quad (\text{Eq.5.19})$$

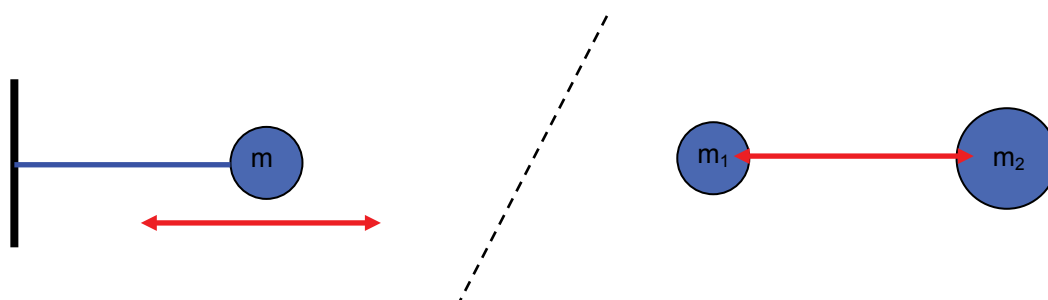

Figure 5.13: Harmonic oscillator (left) and relation to simple molecular vibrations of a diatomic molecule (right)

For HCl, for example, you get a reduced mass of 0.97 g/mol. This means that the heavier Cl-atom is nearly not moving at all, formally representing the solid wall in figure 5.13, against which the much lighter H-atom is vibrating. Energy levels and wave functions of the harmonic oscillator are shown in figure 5.14.

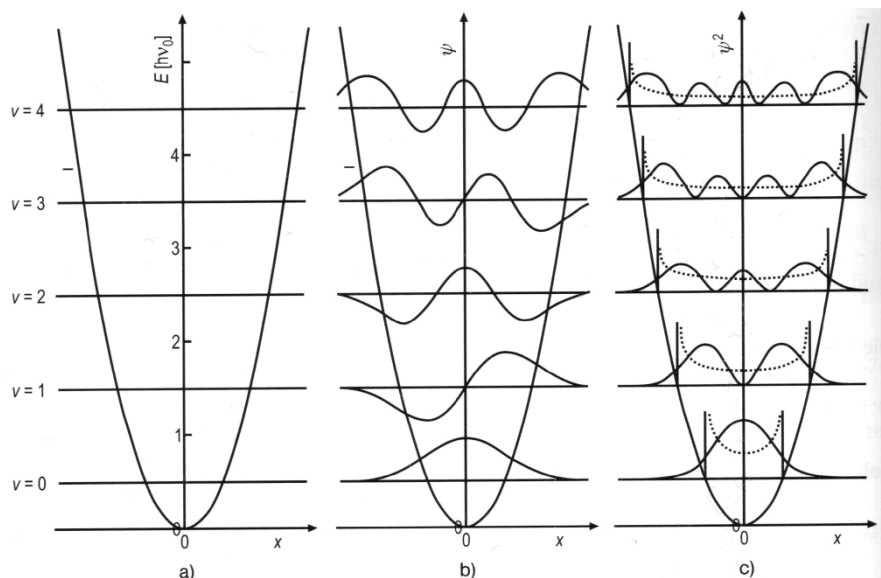

Figure 5.14: energy Eigenvalues (a), wave functions (b), and squared amplitudes (c) of the harmonic oscillator (c) dotted lines = classical probabilities) (from: Gerd Wedler und Hans-Joachim Freund, Lehrbuch der Physikalische Chemie, p. 548, 6.Auflage, Weinheim 2012. Copyright Wiley-VCH Verlag GmbH & Co. KGaA. Reproduced with permission.)

In the past four years we have drilled

81,000 km

That's more than **twice** around the world.

Who are we?
We are the world's leading oilfield services company. Working globally—often in remote and challenging locations—we invent, design, engineer, manufacture, apply, and maintain technology to help customers find and produce oil and gas safely.

Who are we looking for?
We offer countless opportunities in the following domains:

- Engineering, Research, and Operations
- Geoscience and Petrotechnical
- Commercial and Business

If you are a self-motivated graduate looking for a dynamic career, apply to join our team.

What will you be?

careers.slb.com

Schlumberger

In analogy to the particle in a box, the ground state has a non-zero energy. Note that the energy levels here are equi-distant, which is plausible since the potential barrier is getting wider with increasing energy. To apply this concept to real molecular vibrations, we have to take into account that the harmonic potential at high energies formally allows for negative bond lengths (interatomic distance $x < 0$), and also ignores dissociation of the molecule or bond breaking at very high energies. A more realistic potential is therefore the Morse-potential considering these effects (see fig. 5.15):

$$V = V_0 \cdot (1 - \exp(-a \cdot x))^2 \quad (\text{Eq.5.20})$$

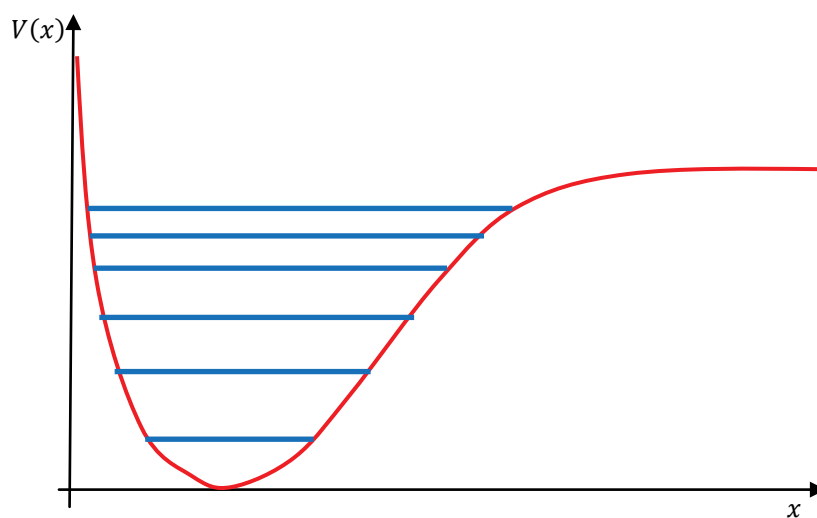

Figure 5.15: Morse potential and resulting energy levels

In Eq. 5.20, V_0 provides a measure for the bond strength (or depth of the potential well = dissociation energy), and the parameter determines the reciprocal bond length. In contrast to the harmonic oscillator potential, the Morse potential is getting wider with increasing energy. As a consequence, the energy levels of the inharmonic oscillator are not any longer equidistant but the energy spacing gets smaller the higher the quantum number. Finally, if the bond is broken at $E > V_0$, the energy spacing becomes zero, or there exists no longer any energy quantization, but we have freely moving atoms.

(iii) Our next example is the so-called stiff rotator, which corresponds to a particle moving on a spherical orbit. In this respect, the model is similar to the particle in a box, i.e. the moving particle has no potential energy but is limited to angular positions between 0° and 360° . Consequently, the energy levels again scale with the quantum numbers squared, $E_m \sim m^2$. The main difference to the particle in a box is that $m = 0, 1, 2, \dots$, i.e. here the ground state is $E_0 = 0$! The corresponding wave function at all rotational angles has a constant amplitude. Therefore, whereas energy and momentum are well-defined ($= 0!$), the positional probability is, in agreement with the Heisenberg-relation, totally undefined.



Figure 5.16: Sketch of the wave function of the ground state for the particle on a ring

Alternatively, one may consider the wavelength of the ground state wave function to be infinitely large, leading according to the de-Broglie equation to a momentum of zero, and therefore also to zero kinetic energy.

(iv) We conclude this section about simple quantum-mechanical models by briefly discussing the solutions of the Schrödinger-equation for the hydrogen atom. The potential energy within the Hamiltonian here is given by the Coulomb-attraction between positively charged nucleus and negatively charged moving electron. Further, due to its very high mass and corresponding momentum of inertia we may consider the nucleus, in respect to the fast moving electron, as stationary. Note that, in contrast to our previous examples, here we have a negative potential whose variation with electron-nucleus-distance is given as

$$V(r) \sim -\frac{1}{r} \quad (\text{Eq.5.21})$$

Consequently, in contrast to the particle in a box we also expect negative energy levels, asymptotically increasing towards zero with increasing quantum number. In the Bohr model presented at the beginning of this chapter we already have seen that

$$E_n \sim -\frac{1}{n^2}, \quad n = 1, 2, 3, \dots \quad (\text{Eq.5.22})$$

From what we have learned so far about quantum mechanics and standing waves, it is very plausible that the energy spacing for the hydrogen atom strongly decreases with increasing quantum number, since the potential barrier in this case is widening much stronger with increasing energy than the parabolic potential barrier of the harmonic oscillator (where we find a constant energy spacing or equidistant energy levels, see fig. 5.14).

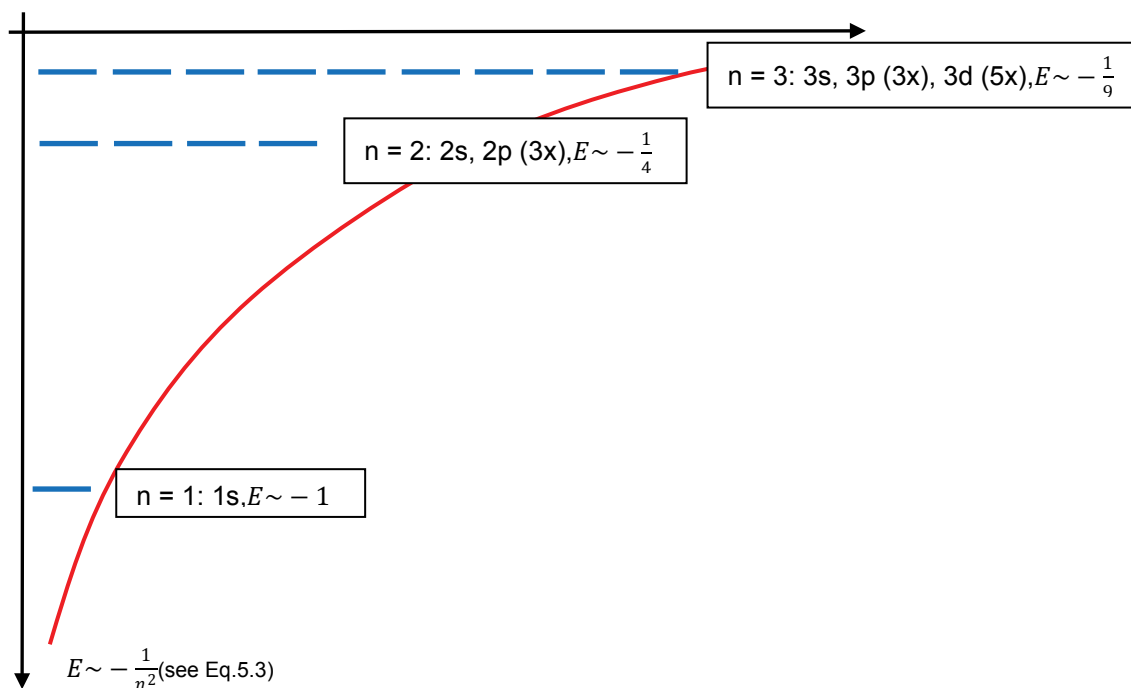

Figure 5.17: Energy levels of the hydrogen atom depending on quantum numbers, red = hyperbolic Coulomb potential keeping the electron close to the positive core. s, p and d correspond to quantum state of the angular momentum of the electron. Note that for hydrogen, the energy eigenvalues only depend on the main quantum number n !



Hellmann's is one of Unilever's oldest brands having been popular for over 100 years. If you too share a passion for discovery and innovation we will give you the tools and opportunities to provide you with a challenging career. Are you a great scientist who would like to be at the forefront of scientific innovations and developments? Then you will enjoy a career within Unilever Research & Development. For challenging job opportunities, please visit www.unilever.com/rjjobs.

Could it be  Unilever



Going into more detail, there is not only the main quantum number n defining the energy of the electronic state of the hydrogen atom (corresponds to K-, L- or M-electronic shell, respectively), but also the quantum number of rotational momentum defining the shape of the orbital (corresponds to s-, p- or d-orbital), as well as the corresponding magnetic quantum number describing the orientation of non-isotropic electron orbitals in space (p_x , p_y or p_z). For the hydrogen atom, these energetic states are degenerate in the sense that the energy level only depends on the main quantum number n , i.e. 3s, 3p and 3d-orbitals all have identical energy levels. For more complex multi-electron atoms, this energetic degeneration is not found any longer.

5.4 A brief introduction to optical spectroscopy

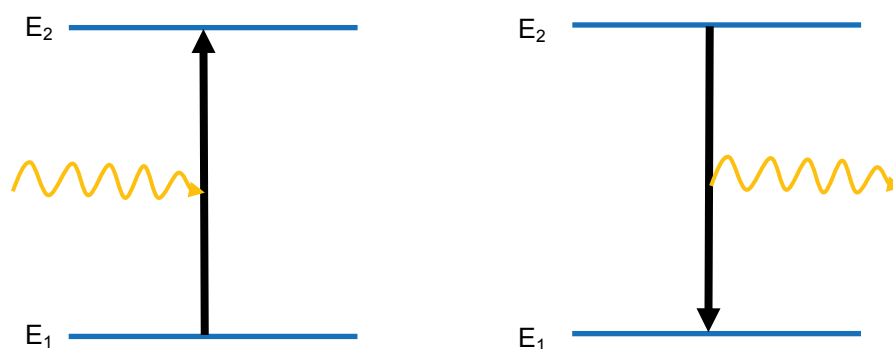

Figure 5.18: Schematics of absorption (left) and emission (right) spectroscopy as energetic transitions between energy eigenvalues E_1 and E_2 , involving either absorption or emission of light of energy $\Delta E = E_2 - E_1 = h\nu = h\frac{c}{\lambda}$.

Optical spectroscopy deals with the absorption or emission of electromagnetic radiation in connection with a transition between energetic states of molecules. Depending on wavelength and therefore energy of the radiation, one may address transitions between electronic states (UV/Vis), molecular vibrations and rotations (IR and microwaves), or magnetic states of the nucleus (radio waves), which will be explained in more detail below. The spectrum in terms of probability of light absorption in dependence of the wavelength of the incident light then directly corresponds to the energy eigenvalues and therefore is characteristic for a given molecule. Consequently, the spectrum may be used as a finger print in qualitative chemical analytics. For quantitative analytics, one can determine the absorption of light at given wavelength, and the concentration of a substance in solution is then given by the law of Lambert-Beer:

$$\log\left(\frac{I}{I_0}\right) = -\epsilon \cdot c \cdot d \quad (\text{Eq.5.23})$$

with I_0 the intensity of the incident light, the intensity of the light passing an optical cuvette of thickness d , ϵ , the molar decadic extinction coefficient specific for a given molecule and wavelength, and the molar concentration of this molecule in solution.

As shown in fig. 5.18, the energy of the electromagnetic radiation absorbed to trigger the transition between different energetic states of the molecule is given as:

$$\Delta E = E_2 - E_1 = h \cdot \nu = h \cdot \frac{c}{\lambda} = h \cdot c \cdot \tilde{\nu} \quad (\text{Eq.5.24})$$

with $\tilde{\nu}$ the wave number of the incident radiation, often used as the important parameter in optical spectra. In contrast to the wavelength λ , $\tilde{\nu}$ is directly proportional to the energy of the transition. Wave lengths, energies and frequencies of electromagnetic waves are summarized in figure 5.19.

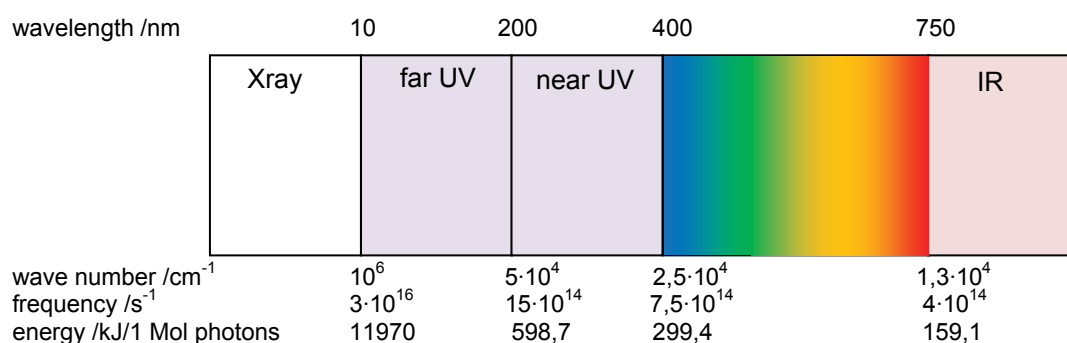

Figure 5.19: wave lengths and energies of the electromagnetic spectrum

In table 5.1, some important spectroscopic methods including energy regime and detected molecular properties are summarized:

λ	ν	$\tilde{\nu}/\text{cm}^{-1}$	$\Delta E/\text{kJ/mol}$	molecular transition	method
100 m–1 m	3 MHz–300 MHz	10 ⁻⁴ –0.01	10 ⁻⁶ –10 ⁻⁴	nuclear spin	NMR
1 cm–100 μm	30 GHz–3·10 ¹² Hz	1–100	0,01–1	molecule rotation	microwave
100 μm –1 μm	3·10 ¹² Hz–3·10 ¹⁴ Hz	100–10 ⁴	1–100	molecule vibration	IR, Raman
1 μm –10 nm	3·10 ¹⁴ Hz–3·10 ¹⁶ Hz	10 ⁴ –10 ⁶	100–10 ⁴	outer (binding) electrons	UV/Vis, fluorescence

Table 5.1: some important spectroscopic methods

Next, let us consider some important principles of optical absorption spectroscopy:

(i) For molecules, each electronic state corresponds to a given strength and length of the chemical bond, and therefore each electronic energy level is further divided energetically into vibrational states (= change of bond lengths and/or bond angles due to molecular vibrations) which themselves are divided into rotational states (= rotation of the whole molecule at given (average) bond lengths and bond angles):

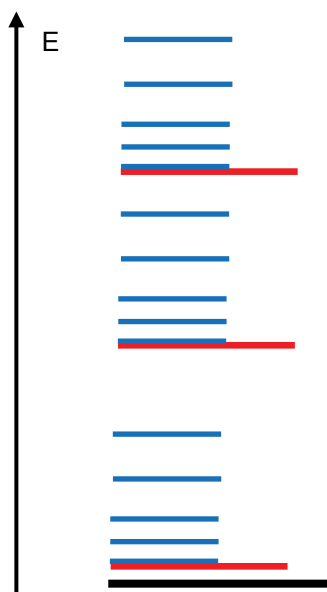

Figure 5.20: Energy levels of molecules: each electronic state (black) contains a set of vibronic states (red), which itself contains a set of rotational states (blue).



Discover the truth at www.deloitte.ca/careers

Deloitte.

© Deloitte & Touche LLP and affiliated entities.



Click on the ad to read more

To excite only the molecular vibrations without simultaneous electronic excitation, incident photons of lower energy or longer wave length are needed (infra red (IR)). Further, to excite only molecular rotations even longer wave lengths are necessary (micro waves). On the other hand, a molecular electronic transition excited by UV/Vis-absorption usually consist of simultaneous vibrational and rotational excitations, wherefore molecular UV/Vis-spectra, in contrast to the spectra of atoms, do not show sharp lines but characteristic broad absorption bands, if the absorption is plotted versus the wavelength of the incident light.

(ii) The Franck-Condon-principle: during the excitation of electronic states of a molecule, typically caused by absorption of UV/Vis-light, the positions of the atomic cores remain unchanged because of the short time scale or high frequency of the incident light ($\sim 10^{-15}$ s). For most molecules, the excited electronic state in respect to that of the ground state is not only corresponding to higher energy but also to larger interatomic distances or bond lengths (see fig. 5.21), since electronic excitation typically causes a decrease in strength and stiffness of the chemical bond. The probability of the electronic transition triggered by light absorption then is proportional to the overlap of the ground vibrational wave function of the electronic ground state, and the vibrational wave functions of the electronically excited state. Note again that, as described in the preceding paragraph (i), not only the electronic state but also the vibrational state of the molecule changes upon absorption of UV/Vis-light! Due to the rapid radiation-less decay of excited molecular vibrations, the emitted fluorescent light is usually red-shifted (= longer wave length or lower transition energy) in respect to the wavelength of absorption (see fig. 5.21).

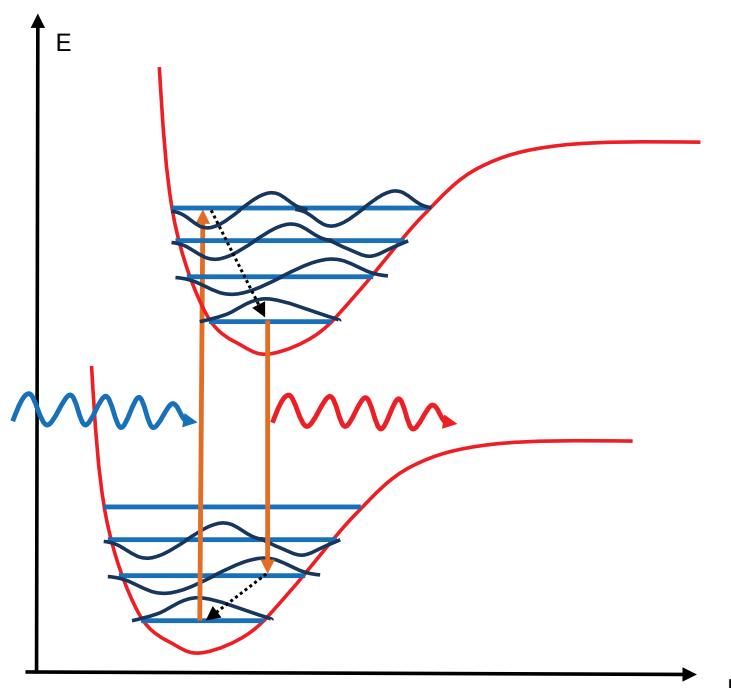

Figure 5.21: electronic transitions and the Franck-Condon principle (E = energy, r = interatomic distance or bond length): the transition has the largest probability at maximum overlap of the vibrational wave functions of the electronic ground and the excited electronic state. This, in combination with a rapid radiation-less decay of the molecules vibrations (dotted black arrows), explains why the emitted light is shifted towards longer wave length (in respect to the absorbed light).

(iii) Molecular energetic transitions can only be triggered by the absorption of light if not only the wavelength is fitting to the energy difference between ground and excited state, but also if the electric dipole momentum of the molecule is changing with the transition. This can be understood on a classical physical basis if we consider light as an electromagnetic wave, and light absorption as an energetic interaction of the electric field vector of the incident light with the electric dipole momentum of the molecular transition. For example, the symmetric oscillation of a CO_2 -molecule cannot be detected by absorption of IR-light, since the dipole momentum does not change for this mode of molecular vibration. On the other hand, the asymmetric vibration of the CO_2 -molecule can be detected by IR-absorption since here the vibrational motion leads to a change of the dipole momentum.

As an illustrative example how to extract molecular characteristics from an optical spectrum, let us consider the rotation-vibration spectrum of HCl in the gaseous state at low pressure. Only in this case the energetic levels are well defined and allow the separate detection of individual rotational levels within the vibrational excitation, whereas at higher pressure or even in the condensed phase peak broadening, mostly due to intermolecular interactions and collisions, leads to a comparatively blurred broad absorption band with no spectral fine structure. The allowed transitions and the resulting spectrum are shown in figure 5.22.

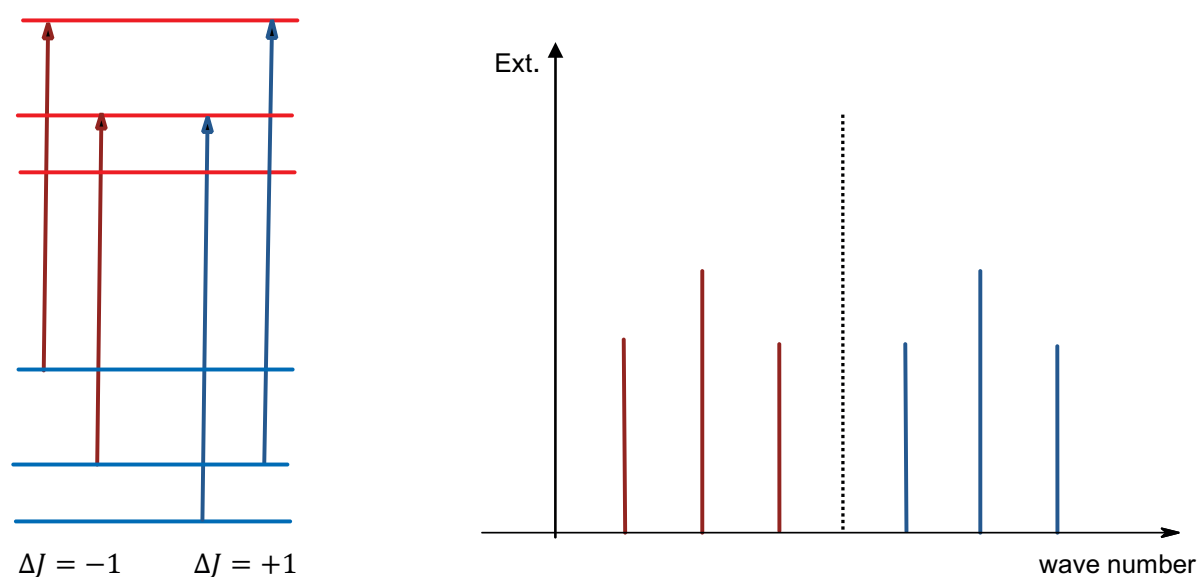

Figure 5.22: Energy transitions (right) and corresponding rotational-vibrational spectrum of HCl (left). Dotted line corresponds to the hypothetical transition $\Delta J = 0$ not found in the HCl-spectrum.

The selection rules of allowed energetic transitions for the spectrum shown in fig. 5.23 are $\Delta v = +1$, i.e. vibrational excitation by one energy level, and $\Delta J = \pm 1$, i.e. rotational excitation with a change in rotational quantum number by ± 1 . These lead to a spectrum containing two series of peaks, one corresponding to at $\Delta J = +1$ higher wave number, and the other corresponding to $\Delta J = -1$ at lower wave number. The gap in between, formally corresponding to $\Delta J = 0$, reflects a purely vibrational transition, and the corresponding wave number allows to directly extract the bond stiffness (see Eq.5.17).

On the other hand, the energy spacing between the two peaks closest to this gap allows us to extract the bond length, since it is directly related to the rotational energy or momentum of inertia. Note that the selection rule is $\Delta J = \pm 1$ based on the conservation of the rotational momentum, a principle also known in classical physics: the absorbed photon has a rotational momentum of 1, and therefore the loss of this momentum upon light absorption has to be compensated by a corresponding change in the rotational state of the molecule. (Note that the rotational momentum of the photon is related to a so-called spin, and also electrons and some atomic nuclei have a spin (the single electron, for example, has spin $\frac{1}{2}$). Some very important spectroscopic methods, for example nuclear magnetic resonance (NMR, see also tab. 5.1) which is also used in medicine for imaging, are related to pure spin transitions. The interested reader is referred here to Physical Chemistry textbooks for details).

Grant Thornton—^{REALLY} a great place to work.

We're proud to have been recognized as one of Canada's Best Workplaces by the Great Place to Work Institute™ for the last four years. In 2011 Grant Thornton LLP was ranked as the fifth Best Workplace in Canada, for companies with more than 1,000 employees. We are also very proud to be recognized as one of Canada's top 25 Best Workplaces for Women and as one of Canada's Top Campus Employers.



Priyanka Sawant
Manager



Audit • Tax • Advisory
www.GrantThornton.ca/Careers



Grant Thornton
An instinct for growth™

© Grant Thornton LLP. A Canadian Member of Grant Thornton International Ltd



Finally, one should note the interesting intensity distribution within a peak series: at room temperature, typically the 3rd peak shows the highest absorption. This is caused by the fact that, according to the Boltzmann distribution, the 3rd rotational state has the highest probability. Finally, one should note that the absorption peaks in the spectrum actually are double-peaks, which is due to the fact that Cl-atoms are found in form of two isotopes of slightly different atomic masses.

The mass of vibrating atoms at given bond strength may have a strong influence on the energy of the vibrational states (see Eq.5.17), or the peak position in an IR-absorption spectrum or, alternatively, a Raman scattering spectrum. For the later, the vibrational energy transition of the molecule corresponds to an energetic shift of the scattered light in respect to the incident wavelength. For a more detailed discussion of Raman spectroscopy, the interested reader should consult one of the textbooks given at the end of this compendium.

The effect of atomic mass on the vibrational energy is best illustrated by the IR- or Raman-spectra of organic molecules containing either hydrogen or deuterium. The doubling in mass has a correspondingly strong isotope effect in the spectrum, i.e. a shift in transition energy by a factor of $\sqrt{2}$ (see Eq.5.17, and figure 5.23).

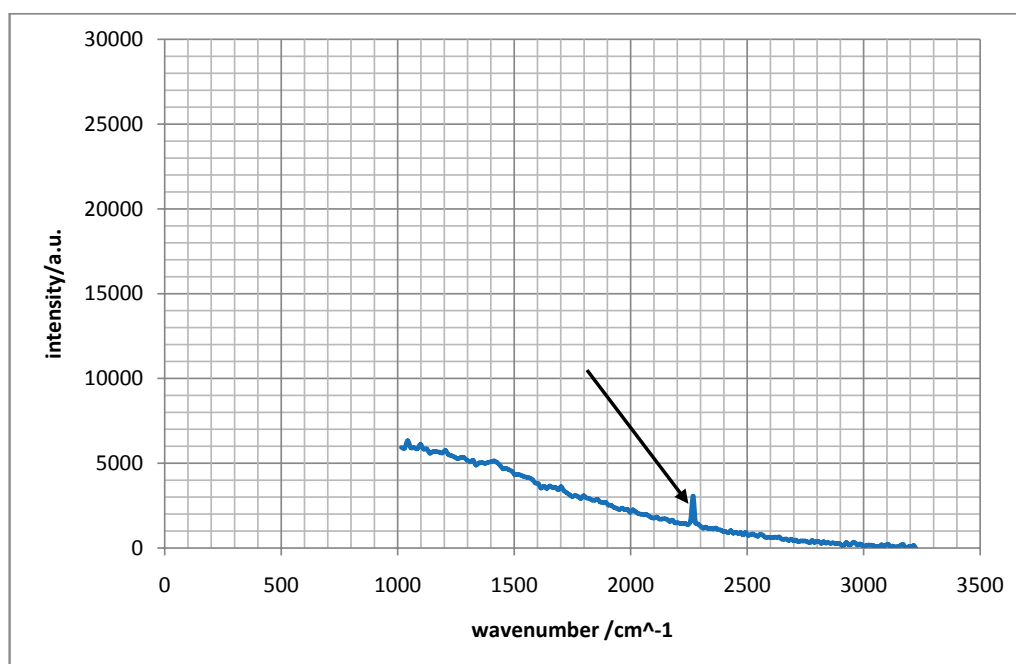
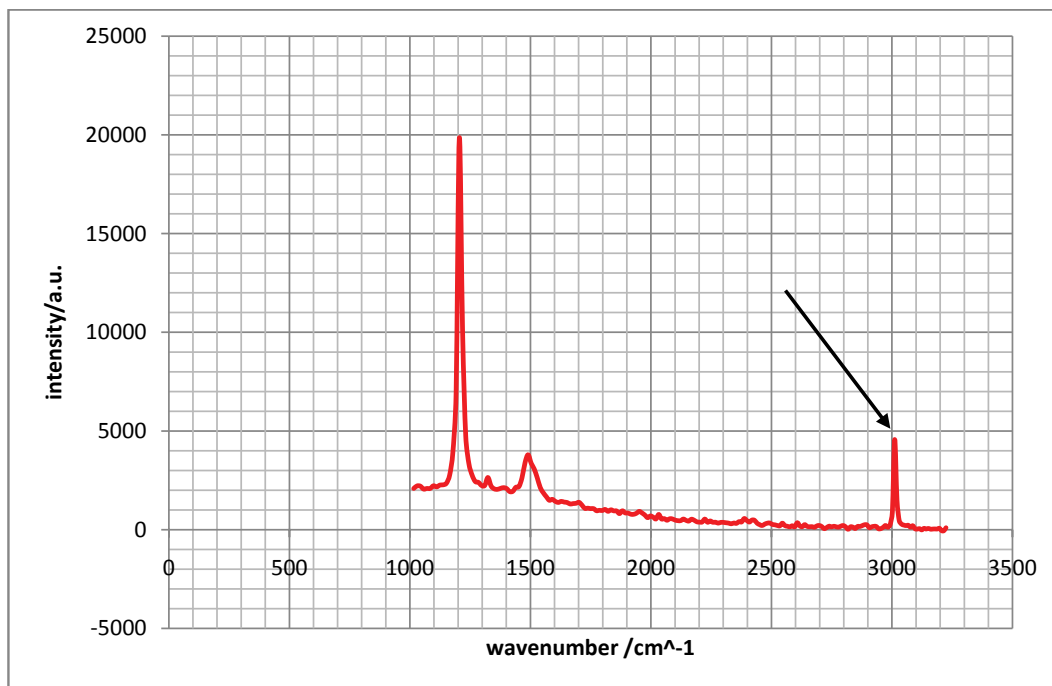

Figure 5.23: Raman-spectra of CHCl_3 (top) and CDCl_3 (bottom) showing the isotope effect (see peaks at highest wave number as indicated by arrows). Both spectra were measured with an iRaman-spectrometer by W. Schärtl at university Mainz, Germany, August 2013.

Example 5.2:

In the high-resolution IR spectrum of HCl taken for a gaseous sample at low pressure, we find a band gap at frequency $8.66 \cdot 10^{13}$ Hz, and an inner spacing between the two series of rotational transitions of $0.12 \cdot 10^{13}$ Hz (see also fig. 5.22). Calculate the bond strength and bond length of the molecule.

Solution:

(i) bond strength

For the HCl molecule, the needed reduced mass is

$$\mu = \frac{M_H \cdot M_{Cl}}{M_H + M_{Cl}} = \frac{1 \cdot 35}{1 + 35} \text{ g/Mol} = 0.98 \text{ g/Mol}$$

Note that this is almost just the mass of the hydrogen. Substituting the midpoint frequency into the expression containing the bond force constant gives:

$$2\pi \cdot \nu = 6.28 \cdot 8.66 \cdot 10^{13} \text{ s}^{-1} = \sqrt{\frac{k}{\mu}}$$

$$k = (6.28 \cdot 8.66 \cdot 10^{13})^2 \cdot \frac{0.98 \cdot 10^{-3}}{6.02 \cdot 10^{23}} \text{ N/m} = 481 \text{ N/m}$$

(ii) bond length

The separation between the two series of spectral peaks is twice the rotational energy change from quantum number $J = 0$ to $J = 1$. This energy is related to the momentum of inertia, i.e.

$$\Delta E = \frac{2 \cdot \left(\frac{h}{2\pi}\right)^2}{2I} = h \cdot 0.12 \cdot 10^{13} \text{ s}^{-1}, \quad \text{with} \quad I = \mu \cdot r^2$$

Therefore, the bond length is given as:

$$r^2 = \frac{2 \cdot \left(\frac{h}{2\pi}\right)^2}{\mu \cdot h \cdot 0.12 \cdot 10^{13} \text{ s}^{-1}} = \frac{2 \cdot \left(\frac{6.626 \cdot 10^{-34}}{6.28}\right)^2}{\frac{0.98 \cdot 10^{-3}}{6.02 \cdot 10^{23}} \cdot 6.626 \cdot 10^{-34} \cdot 0.12 \cdot 10^{13}} \text{ m}^2 = 1.72 \cdot 10^{-20} \text{ m}^2, \text{ or } r = 0.13 \text{ nm}$$

We conclude this chapter (and our booklet) by reviewing the spectroscopic transitions between electronic states of molecules in more detail. The following scheme called Jablonski-diagram summarizes the possible transitions (see fig. 5.24):

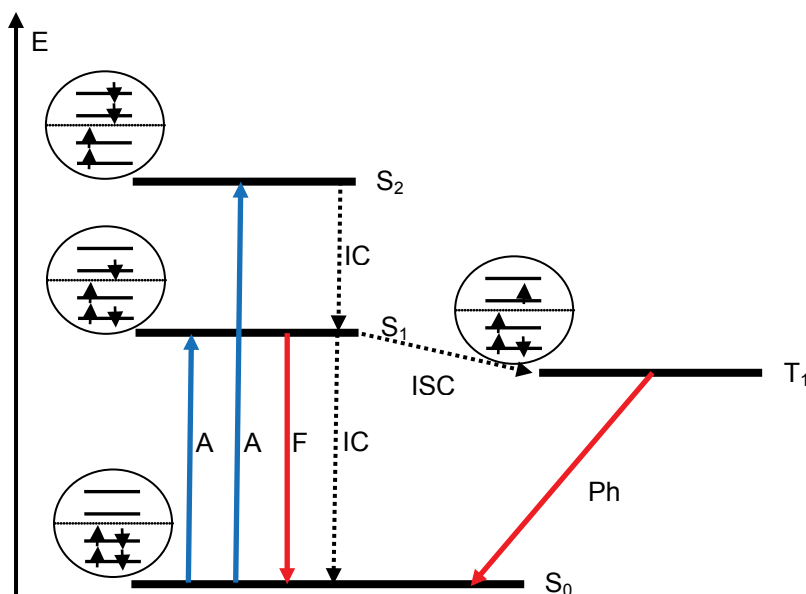

Figure 5.24: Jablonski diagram showing electronic excitation and different pathways of energy relaxation (with and without (dotted) radiation absorption/emission). Circles indicate the electronic configuration of the respective electronic states, the arrows indicate the electron spin direction ($+\frac{1}{2}$ (up) or $-\frac{1}{2}$ (down)). See text for details.

Upon UV/Vis-irradiation and absorption of light (A), the molecule shows an electronic transition from the ground state S_0 to an excited electronic state S_1 (or S_2) by lifting one electron (or two electrons) to a higher energetic state while conserving the spin orientation. Note that simultaneously the excitation of molecular vibrations is usually found (see also fig. 5.21). Next, the excited energy is partially converted via a rapid radiation-less process called internal conversion (time-scale: 10^{-12} seconds) (IC) into heat, before radiation is emitted from the vibrational ground state of S_1 to an excited vibrational state of S_0 (F). This emission called fluorescence, on a time-scale of 10^{-9} – 10^{-6} seconds, is therefore shifted, in respect to the wavelength of the incident light, towards longer wavelength (red-shift).

Some molecules, especially those containing heavier atoms like S or P, show a competing process, a radiation-less transition from S_1 to an excited triplet state T_1 , where the orientation of the spin of the excited electron is reversed. This process called intersystem crossing (ISC) is usually forbidden and therefore very slow, since it violates the physical principle of the conservation of the rotational momentum. However, in case of heavier atoms the change in the electron spin orientation may be compensated by a corresponding change in the electrons angular momentum, a phenomenon called “spin-orbit-coupling” strongly speeding up the ISC to a time scale so it can compete with fluorescence. From the triplet state, the system decays via emission of radiation on a very slow time scale (1-100 s), and this emission is called phosphorescence (Ph).

Subject index

A

Absorption, of light, 135, 138, 145, 154f
Absorption spectroscopy, 155
Activity coefficient, ionic, 110
Adiabatic, process, 18, 32
Atoms, Models, 133f
 electronic structure, 136 f
 optical emission spectrum, 137

B

Boiling, temperature, 52
 phase diagram of binary systems, 63, 65

C

Carnot process, 34f
Chemical potential, 56f
Colligative properties, 60
 depression of freezing point, 68
 elevation of boiling point, 60
 osmotic pressure, 77
 relative lowering of vapor pressure, 62
Conductivity, electrical, 101
Constant, Boltzmann, 22
 Faraday, 102
 Gas, 25
 Michaelis, 97
 Planck, 136
 Van der Waals, 26, 31
Critical point, 28, 29

D

Degrees of freedom, microscopic, 47
Degrees of freedom, Gibbs phase rule, 50
Differential equations, 10ff
Distribution, of velocities, ideal gas, 22, 23

E

Eigenfunktion, wave function, 145
Electromotive force, 127
Electron, diffraction, 141
Endotherm, 81
Energy, average of ideal gas, 25
 activation, 98f

dissociation, 151
excitation, 157
kinetic, 25
quantized hydrogen atom, 153
quantized oscillator, 150, 151
quantized particle in a box, 147, 148
quantized rotator, 152

Enthalpy, 32

free, 43f
free, of mixing, 57

Entropy, 34, 39

mixing, 57

Error calculation, 14f

Equilibrium, homogeneous,
 chemical, 81
 phase, 50f

Eutectic, 71**Exotherm, 81****Expansion**

of ideal gases
 adiabatic, 33, 34
 isobar, 32
 isotherm, 32, 33

F**Fluorescence, 163****Free energy, 43**

Frequency, electronic transition, 155
 molecular vibration, 155

Freezing point, suppression of, 68, 69**Function, wave, 145****G****Gas laws, ideal, 20, 25**

real gas, equation of state, 26
real gas, isotherms, 29

H

Heat capacity, at constant volume, 32, 47
 at constant pressure, 32, 47
 of gases, 47
 of solids, 48

- Heat of chemical reaction, 81
 temperature dependence, 86
- Heat of Evaporation, 52
 melting, 53
 sublimation, 53
- I**
- Ion cloud, 112
- Ions, migration of, 103f, 106
- Ionic strength, 115
- Isobar, process, 18, 32
- Isochor, process, 18, 32
- Isotherm, process, 18, 32
- J**
- Joule effect, 33
- K**
- Kinetics, of elementary reactions, 89f
- Kinetic theory of the ideal gas, 22f
- L**
- Law, Arrhenius, 23, 98
 Boltzmann's, 22
 Braggs', 141
 Clausius, 39
 Dalton's, Henry, 62
 de Broglie's, 142
 Gay-Lussac's, 19
 Ideal gas, 20
 Kirchhoff's, 86
 Kohlrausch's, 117
 Nernst's, 127
 Ostwald's, 109
 Raoult's, 62
- Light, absorption (see absorption, of light)
 velocity
- Lindemann mechanism, 95f
- M**
- Melting, temperature, 53, 68
 phase diagram of binary systems, 68f
- Michaelis-Menten kinetics, 96f
- Migration of ions, 103
- Mixing of gases, entropy, 57
 free enthalpy, 57
- Mobility, ionic, 103
- Models, atomic, see atoms, models
- Morse potential, 151
- O**
- Orbits, electronic, 135f
- Order of reaction, 87
- Oscillator, linear harmonic, 149f
 linear anharmonic, 151
- Osmosis, 77f
- P**
- Partial quantities, 54, 56
- Particle in the box, 145f
- Phase diagrams, pure components, 51f
 binary systems, 63, 65, 66, 71, 74
- Phase equilibria, 51
- Phase rule, Gibbs, 50
- Phosphorescence, 163
- Photo-electric effect, 139f
- Photons, 140, 142, 159
- Potential, chemical, 56f
 electrode, 121f
 membrane, 125f
- Process, cyclic, 35f
 reversible, 35
- Pressure, osmotic, see osmosis
 partial, 57, 62
- Q**
- Quantum numbers, 138, 147, 151
- Quantum theory, 145f
- R**
- Radiation, absorption, see absorption of light
 emission, 154, 163
- Raman effect, 160, 161
- Reactions, catalyzed, 89
 Enzyme, 96
 first order, 89
 heterogeneous, 89
 second order, 90
- Resistance, electrical, 104, 105
- Rotation, quantum states, 151, 158

S

Selection rules, 159
Series, expansion (Taylor), 13
 spectral, 137, 158
Singlet state, 163
SI system, 14
Solutions, ideal, 57
Specific heat, see heat capacity
Spectra, atomic, 137
 molecular, 155, 157, 158
 Raman, 161
Spin, of an electron, 163
Standard conditions, 19, 57, 85
Stationary state hypothesis, 95, 96
Stirling process, 38
Sublimation, 53

T

Temperature, absolute, 14, 19
 critical, 28f
 transition, 51f
Thermochemistry, 85
Thermodynamic machines, coupling, 40f
Thermodynamics, first law, 32
 second law, 34f, 39
 third law, 46
Triplet state, 163
Tunnel effect, 148

V

Vapor pressure, of pure liquids, 52
 of ideal solutions, 62
Vibration, linear harmonic, see oscillator
Volume, change of during mixing, 54f
 partial molar, 55