

A photograph of a city skyline reflected in a body of water. The water is dark blue and green, and there is a significant amount of floating trash, including a large green plastic bag and various smaller pieces of debris. The city buildings are reflected in the water, and the sky is a pale blue with some clouds.

Marine Pollution

Dr. Geert Potters

Dr. Geert Potters

Marine Pollution

Marine Pollution

1st edition

© 2013 Dr. Geert Potters & bookboon.com

ISBN 978-87-403-0540-1

Contents

	List of tables	7
	List of figures	9
	Foreword	12
1	What is pollution?	14
1.1	Introduction	14
1.2	Definitions	16
1.3	Classification of pollution forms	16
1.4	Sources	19
1.5	Read more?	28
2	How to measure pollution	30
2.1	Measuring pollution is more difficult than you think	30
2.2	Measuring toxicity the classical way	40
2.3	Using biological responses as a marker for pollution	48



 **OLIVER WYMAN**



Oliver Wyman is a leading global management consulting firm that combines deep industry knowledge with specialized expertise in strategy, operations, risk management, organizational transformation, and leadership development. With offices in 50+ cities across 25 countries, Oliver Wyman works with the CEOs and executive teams of Global 1000 companies.
An equal opportunity employer.

GET THERE FASTER

Some people know precisely where they want to go. Others seek the adventure of discovering uncharted territory. Whatever you want your professional journey to be, you'll find what you're looking for at Oliver Wyman.

Discover the world of Oliver Wyman at oliverwyman.com/careers



Click on the ad to read more

2.4	Molecular effects: single biomarkers	49
2.5	Modern technology: ecotoxicogenomics	58
2.6	Modifications to tissues and organs	69
2.7	Biomarkers on the organismal level	73
2.8	Effects on ecosystems	86
2.9	Read more?	92
3	Inorganic pollutants	101
3.1	Inorganic nutrients and eutrophication	101
3.2	Carbon dioxide and ocean acidification	114
3.3	Metal pollution	118
3.4	Read more?	131
4	Oil and organic pollution	134
4.1	The polluting organic chemicals	134
4.2	Oil spills	134
4.3	Polycyclic aromatic hydrocarbons	150
4.4	Halogenated hydrocarbons	155
4.5	Read more?	175

Day one
and you're ready

Day one. It's the moment you've been waiting for. When you prove your worth, meet new challenges, and go looking for the next one. It's when your dreams take shape. And your expectations can be exceeded. From the day you join us, we're committed to helping you achieve your potential. So, whether your career lies in assurance, tax, transaction, advisory or core business services, shouldn't your day one be at Ernst & Young?

What's next for your future?
ey.com/careers

ERNST & YOUNG
Quality In Everything We Do

© 2010 EYGM Limited. All Rights Reserved.



5	Newer forms of pollution	183
5.1	Plastics	183
5.2	Noise pollution: the death of a thousand cuts	191
5.3	Hitching a ride: invasive species	203
5.4	Read more?	209
6	Policy and pollution	212
6.1	The How and Why of pollution: The Tragedy of the Commons	212
6.2	The Oceans as Commons	213
6.3	International Convention for the Prevention of Pollution from Ships (MARPOL)	218
6.3	MARPOL 73/78: it all started with oil pollution measures...	220
6.4	The MARPOL Annexes: beyond oil pollution	223
6.5	Read more?	229
7	Envoi	230
8	Endnotes	231

In the past four years we have drilled

81,000 km

That's more than **twice** around the world.

Who are we?
We are the world's leading oilfield services company. Working globally—often in remote and challenging locations—we invent, design, engineer, manufacture, apply, and maintain technology to help customers find and produce oil and gas safely.

Who are we looking for?
We offer countless opportunities in the following domains:

- Engineering, Research, and Operations
- Geoscience and Petrotechnical
- Commercial and Business

If you are a self-motivated graduate looking for a dynamic career, apply to join our team.

What will you be?

Schlumberger

careers.slb.com



List of tables

- Table 1-1. Types, sources, and effects of marine pollution
- Table 2-1. Examples of the speciation of mercury(II)hydroxide and the associated equilibrium constant for each reaction
- Table 2-2. Dissociation constants of metal organic complexes in seawater
- Table 2-3 GESAMP evaluation system for hazardous chemicals
- Table 2-4. Variation in biomagnification studies
- Table 2-5. Acute histological changes in the gills of *Mytilus edulis*
- Table 2-6. A summary of the reviewed histocytological biomarkers
- Table 2-7. A number of well-known examples of hormones.
- Table 2-8. Overview of potential pseudohormones and hormone antagonists
- Table 2-9. Tributyltin (TBT) – harmful effects on the environment (IMO,2002)
- Table 2-10. Sexual behaviour changes of male medakas treated with TBT and/or PCBs
- Table 2-11. Study of metal pollution and ecosystem structure in Seoul, Korea
- Table 3-1. Major forms of nitrogen in the ocean
- Table 3-2. pH changes since the Industrial Revolution
- Table 3-3. Essential metals for living organisms on Earth
- Table 3-4. Metal emissions into the atmosphere (in kiloton year⁻¹)
- Table 3-5. Examples of smallest and largest concentrations of several non-essential metals
- Table 3-6. Mercury in tissue samples from Minamata.
- Table 4-1. Concentration ranges of some organic contaminants in marine organisms
- Table 4-2. Average composition of mineral oil
- Table 4-3. Types of oil and their physical properties
- Table 4-4. Major oil spills since 1967
- Table 4-5. Incidence of spills
- Table 4-6. Classification of shorelines in order of increasing vulnerability to oil spills damage
- Table 4-7. Physio-chemical properties of selected PAHs
- Table 4-8. Half lifes of different PAHs under different conditions
- Table 4-9. The history of DDT: curiosity, common usage, catastrophe
- Table 4-10. The “Dirty Dozen”
- Table 4-11. Atmospheric and river input of different halogenated hydrocarbons into the ocean (in tons/year)
- Table 4-12. Persistence of chlorinated hydrocarbon insecticides in agricultural soils.
- Table 4-13. Concentrations of some polychlorinated biphenyls and chlorinated pesticides
- Table 4-14. Behavioural responses in *Ectoparasitus maculatus* exposed to lindane
- Table 4-15. Correlation between parasitic infection and exposure to organohalogens
- Table 4-16. Organochlorine concentrations in organisms from the Barents Sea
- Table 4-17. Genes affected by two types of polychlorinated biphenyl exposures

- Table 4-18. Thyroid hormones changes due to exposure to PCBs
- Table 5-1. Biodegradation time for frequently used objects.
- Table 5-2. Density of the Medium, Speed of sound, and acoustic impedance
- Table 5-3. Sound wave reflection coefficients (with respect to seawater)
- Table 5-4. Sounds from marine organisms
- Table 5-5. Distribution of commercial ships according to their type and size in 2011
- Table 5-6. Summary of sound frequencies produced by shipping traffic and their source levels.
- Table 6-1. Borders at sea
- Table 6-2. Appendix to Annex III
- Table 6-3. MARPOL garbage disposal criteria (from 2013 onwards)
- Table 6-4. NO_x limits in function of engine performance.
- Table 6-5. Special areas according to the different MARPOL Annexes.

List of figures

- Figure 1-1. Share of the different sources of pollution into the marine environment
- Figure 1-2. Inputs of pollution into the marine environment
- Figure 1-3. Biofouling organisms
- Figure 1-4. Pollution finds its way off the ship
- Figure 1-5. Imposex in dog whelks
- Figure 1-6. Hydrothermal circulation
- Figure 2-1. Processes influencing the availability of a chemical compound in an ecosystem
- Figure 2-2. Several physicochemical and biological transformations of As in a marine ecosystem
- Figure 2-3. Schematic representation of the process of biomagnification
- Figure 2-4. Biomagnification of DDT in an aquatic food chain
- Figure 2-5. The different biological hierarchical levels of impact of a pollutant
- Figure 2-6. Typical test organisms in a toxicological test
- Figure 2-7. The position of the LD50 or median lethal dose on a toxicity curve
- Figure 2-8. Definition for NOAEL and LOAEL on the basis of the toxicity curve
- Figure 2-9. Reaction path of the cytochrome P450
- Figure 2-10. Cytochrome P450 is activated after hydrocarbon exposure
- Figure 2-11. Glutathione: the tripeptide γ -glutamyl-cysteinyl-glycine
- Figure 2-12. UDP-Glucose
- Figure 2-13. Expression of metallothioneins in gills of *Sinopotamon yangtsekiense* exposed to Cd
- Figure 2-14. Phytochelatin (n lies between 2 and 10)
- Figure 2-15. Effect of pollution on biomarkers in mussels collected in South Brazil
- Figure 2-16. The different metabolic pathways from dioxygen to water
- Figure 2-17. Molecular structures of ascorbic acid (top) and alpha-tocopherol (bottom)
- Figure 2-18. Malondialdehyde
- Figure 2-19. The different branches of ecotoxicogenomics
- Figure 2-20. Molecular structures of dyes cyanine-3 and cyanine-5
- Figure 2-21. Schematic representation of a microarray experiment
- Figure 2-22. Example of a transcriptome study on a marine diatom
- Figure 2-23. Examples of protein phosphorylation
- Figure 2-24. Alternative protein modifiers
- Figure 2-25. 2D gel electrophoresis
- Figure 2-26. Proteome study methods
- Figure 2-27. Ecotoxicological proteome analysis
- Figure 2-28. Healthy (left) and necrotic gill tissue in the crab *Cancer irroratus* exposed to sewage sludge.
Taken from Young and Pearce (1975)
- Figure 2-29. Inflammatory responses in mussels living in polluted water

- Figure 2-30. Hans Selye (left) and his General Adaptation Syndrome model (right)
- Figure 2-31. Hormesis: growth stimulation by stress
- Figure 2-32. SFG of mussels
- Figure 2-33. Scope for growth (SFG) and cellular energy allocation (CEA) of *Neomysis integer* (Crustacea: Mysidacea) following exposure to chlorpyrifos
- Figure 2-34. Effect of pollution on Scope for Growth
- Figure 2-35. Atlantic salmon smolt with spinal deformities
- Figure 2-36. Action of hormones (left), pseudohormones (middle) and hormone antagonists (right)
- Figure 2-37. The typical female (left) and male (right) sex hormones in vertebrates
- Figure 2-38. Tributyltin
- Figure 3-1. The terrestrial nitrogen cycle
- Figure 3-2. Nitrogen assimilation
- Figure 3-3. Endophytic form of the cyanobacterium *Richelia intracellularis*
- Figure 3-4. The marine nitrogen cycle
- Figure 3-5. Quantification of nitrogen fluxes
- Figure 3-6. Schematic of the biological pump
- Figure 3-7. The process of eutrophication
- Figure 3-8. Red tide at La Jolla San Diego, California
- Figure 3-9. Algal bloom around the island of Goteborg, Sweden
- Figure 3-10. *Karenia brevis*, a dinoflagellate that causes harmful algal blooms
- Figure 3-11. Eutrophication in the Sea of Azov
- Figure 3-12. Corals on the Great Barrier Reef near Cairns, Queensland, Australia
- Figure 3-13. Dose-response curves for essential and non-essential metals
- Figure 3-14. Vegetation loss due to metal pollution in Siberia
- Figure 3-15. Global production and consumption of selected toxic metals, 1850–1990
- Figure 3-16. Pathway of metal contaminants in the food chain
- Figure 3-17. Lead contamination in Greenland snow cores
- Figure 3-18. Correlation between lead use in gasoline and lead concentrations in the air
- Figure 3-19. Different exposure pathways for Cd in humans
- Figure 3-20. Influx of Cd into aquatic ecosystems
- Figure 3-21. Mercury cycling in the Arctic Ocean
- Figure 3-22. Bio-accumulation of mercury in the Arctic food chain
- Figure 4-1. Sources of oil spills
- Figure 4-2. Oil spills due to shipping
- Figure 4-3. Natural degradation of an oil spill
- Figure 4-4. Succession in time of the physicochemical processes that transform an oil spill
- Figure 4-5. Famous oil spills
- Figure 4-6. Victims of the Exxon Valdez oil spill
- Figure 4-7. Ways to deal with an oil spill

- Figure 4-8. Examples of polycyclic aromatic hydrocarbons
- Figure 4-9. Sources of PAHs
- Figure 4-10. Effect of PAHs on embryonic development
- Figure 4-11. Aerobic breakdown of DDT with formation of different metabolites
- Figure 4-12. Chlorinated insecticides
- Figure 4-13. Effect of dieldrin, lindane and methoxychlor (MXC) on sperm functioning
- Figure 4-14. Kidney necrosis due to lindane treatments
- Figure 4-15. Top: general structure of a PCB; bottom: examples of PCBs
- Figure 4-16. Detail of a PCB-affected fish hepatocyte
- Figure 4-17. Gonadal somatic index after exposure to different amounts of TCB
- Figure 4-18. Dioxins and furans
- Figure 4-19. Dioxin signalling leads to an enhanced detoxification
- Figure 4-20. Possible mechanism for tumour formation through the aryl hydrocarbon receptor
- Figure 5-1. Ocean surface currents. Source: NOAA, USA
- Figure 5-2. 28,800 Friendly Floatees lost at sea
- Figure 5-3. Nurdles
- Figure 5-4. Albatros remains
- Figure 5-5. Plastic production worldwide and in the European Union
- Figure 5-6. Macroplastic waste in the sea
- Figure 5-7. A travelling sound wave has amplitude and pitch
- Figure 5-8. Propagation of a sound wave
- Figure 5-9. Dispersion of the wave energy from a point source
- Figure 5-10. Impedance and wave reflection at the water-air boundary
- Figure 5-11. The use of sonar for the analysis of the ocean soil
- Figure 5-12. Overview of some important sources of sound in the marine world
- Figure 5-13. Number of marine exotic species introduced by the most common ways
- Figure 5-14. Several marine invasive species
- Figure 6-1. Three documents dealing with the ownership of the oceans
- Figure 6-2. Borders and zones at sea according to UNCLOS
- Figure 6-3. The Exxon Valdez
- Figure 6-4. The double hull configuration
- Figure 6-5. Labels to identify marine pollutants

Foreword

Nothing so vast as Earth's Oceans. Nothing so unknown on our planet as its variety of life, in morphology and in functioning, as the billions of organisms sheltered in the waters. Nothing so important for maintaining a homeostatic equilibrium on Earth, beneficial for all its inhabitants, including mankind. And nowadays – nothing as threatened in its core existence: pollution along the coasts and in the deep sea, mining of the resources so far buried under several kilometres of water, the atmospheric rise in carbon dioxide being buffered by the ocean's carbon sinks (changing conditions for life in that ocean), overfishing leading to a possible annihilation of all commercial fish stocks by 2050, invasive species being shuttled to all corners of the world by an ever-growing number of commercial ships, noise levels drowning out whale songs and shattering the ears of dolphins... No, reading about the state of the oceans is certainly not an agreeable activity and does not sooth our minds longing for a better and cleaner world.

Who needs more reasons to write about these problems...



Hellmann's is one of Unilever's oldest brands having been popular for over 100 years. If you too share a passion for discovery and innovation we will give you the tools and opportunities to provide you with a challenging career. Are you a great scientist who would like to be at the forefront of scientific innovations and developments? Then you will enjoy a career within Unilever Research & Development. For challenging job opportunities, please visit www.unilever.com/rdjobs.

Could it be  Unilever



Nevertheless, aside from a more lyric ending and overture, the text aims to give a broad overview of both the methods used in the investigation of this interaction (Chapter 2), as well as of the pollutants involved (Chapters 3, 4 and 5): once a student has worked through the text, he/she should be able to explain the basic mechanisms behind pollution processes and pollution effects on the oceans. More – said students should have acquired a suitable level of understanding from this book to dive into the vast quantity of scientific literature itself, and look for the major issues that are being studied today. To this end, a suitable sample of this literature has been used directly as core material, and the avid reader is referred directly to several interesting research reports, even from the past months.

It is not possible to build up to such a goal from essentially nothing. The text therefore supposes some pre-existing knowledge on biochemistry and animal physiology (especially in the second chapter), and a basic understanding of chemistry throughout the text. Some familiarity with the animal groups in the world seas is also quite useful. The reader is therefore probably an advanced undergraduate or master student.

Finally, a big word of thanks to my esteemed colleagues and friends, Dr. Helen Verstraelen of the Antwerp Maritime Academy and hydrobiologist, teacher and science communicator Chris Thoen for their many corrections, amendments, suggestions and constructive criticism to the present text. That the text contains fewer mistakes, is thanks to them; that the text is still a work in progress, is due to myself.

Geert Potters, PhD
Antwerp, 1 September 2013

1 What is pollution?

The sedge is wither'd from the lake, And no birds sing.
John Keats, *La Belle Dame sans Merci*

1.1 Introduction

“The “control of nature” is a phrase conceived in arrogance, born of the Neanderthal age of biology and philosophy, when it was supposed that nature exists for the convenience of man.” Including this sentence in the closing paragraphs of her illustrious milestone book, *Silent Spring*, the eminent American ecologist Rachel Carson (1962) emphasizes the crucial and infamous role man has played in the downgrading of his own natural habitat. The book was meant to point the attention of the scientific world as well as of the interested general public to the problem posed by the unchecked release of many chemicals, mainly pesticides, in the natural environment¹. As such, *Silent Spring* immediately became the birth cry of the developing environmental movement on Earth – a movement comprised still of a multitude of people, with different backgrounds, different principles and even different objectives in life, but all driven to make the planet a better and healthier place to live for our children and the generations thereafter.

The publication of this book was followed up by a series of events that did all but strengthen the incipient care for the environment: a number of oil spills (the tanker Torrey Canyon in 1967 along the coast of southwest England, an offshore well in 1969 in the Santa Barbara channel in California, the Amoco Cadiz in 1978), as well as several large scale poisonings (the jurisdictional proceedings on a case of mercury poisoning of the inhabitants of Minamata, Japan in 1971, the Seveso disaster in Italy in 1976 and the methyl isothiocyanide gas release in 1984 at the Union Carbide India Limited pesticide plant in Bhopal).

At the same time, some concern started to brew as to the possible existence of limitations on the exponential expansion of the human population on Earth, brought forward in the 1968 book *The Population Bomb* by Paul Ehrlich. This concern was underpinned by the first images of Earth from space, which helped us to grasp the idea that Earth has indeed her limits and may not suffice to sustain further growth of the human population or human economic activity. This question (“are there limits to the human growth?”) was answered for the first time by a multidisciplinary team of scientists and politicians, commonly known as the Club of Rome. Their 1972 report *The Limits to Growth* in 1972 was the first of many, indicating the growing pressure of mankind on its home planet and its resources.

All of this has made continually growing parts of the human population aware that actions should be taken to prevent further deterioration of the conditions on the planet. We only have one, and it has to last quite a lot longer.

One of the ecosystems where the impact of mankind has been felt severely, is the marine world. For a long time, man has felt that the oceans were so vast and so full of life, that they could not be depleted, and that they could tolerate whatever level of pollution we would throw at them. Chemicals that were dumped in the deep sea were thought to have disappeared forever. Nothing was ever less true, as we can see now: mankind has managed to deplete a large percentage of the fish populations and has marked a number of the largest mammals on the planet for extinction. Animals and plants have been transported both knowingly and unknowingly to the other side of the globe and were found to thrive in their new locations and even to drive out the indigenous species. Coast ecosystems have been overrun by large quantities of nitrogen, phosphorus and heavy metals, changing the food relations for the organisms in these habitats. And lastly, mankind has created literally hundreds of thousands of chemicals, never before seen on the planet, affecting the health of all creatures in the ocean, including man itself.

The result of all these actions can be researched in detail on "A Global Map of Human Impacts on Marine Ecosystems", see <http://globalmarine.nceas.ucsb.edu/>.

It is only when these consequences of our behaviour came back to haunt ourselves, that action was finally undertaken. But later more about that (Chapter 6. Policy and pollution).



Discover the truth at www.deloitte.ca/careers

Deloitte.

© Deloitte & Touche LLP and affiliated entities.



1.2 Definitions

Contamination is, *sensu stricto*, used to describe the fact that a certain chemical compound is present in a certain habitat and/or the organisms living there, at a concentration higher than normal or the background value, and this due to non-natural causes.

Pollution can then be defined as any form of contamination in an ecosystem with a harmful impact upon the organisms in this ecosystem, by changing the growth rate and the reproduction of plant or animal species, or by interfering with human amenities, comfort, health, or property values. In a broader sense, the terms contamination and pollution also include any physical modification that alters the energy or radiation flow in an environment (such as a heat source or sink, or a radioactive element), or even the presence of an invasive species.

Hence, marine pollution as defined by the Group of Experts on the Scientific Aspects of Marine Pollution (GESAMP), as part of the basic framework of the UN Convention on the Law of the Sea (UNCLOS) 1982 (Article 1.4), is:

“the introduction by man, directly or indirectly, of substances or energy into the marine environment (including estuaries) resulting in such deleterious effects as harm to living resources, hazards to human health, hindrance to marine activities including fishing, impairment of quality for use of sea water, and reduction of amenities.”

In this text, we will mainly focus on the strict definition of pollution. Only in 5.2 and 5.3 will we address other, newly defined types of pollution, such as underwater noise and invasive species.

1.3 Classification of pollution forms

Pollutants can be classified in different ways. First of all, they can be distinguished according to their **physicochemical constitution**. Some compounds are inorganic (like the atmospheric pollutants NO, NO₂, and SO₂ or like metal ions); other types of pollution are more organic in nature (like wastewater, the nitrogen and phosphorus-laden run-off of agraric land or petroleum derivatives). Newer forms are even not chemical in origin (sound, light). The **physical state** is another parameter to distinguish between different pollutants. Some types are found in solid form, such as the plastic debris in the Pacific, but also the remains of sludge after bagger works. Other types are found in the atmosphere, either as drifting solids (flying ashes, heavy metals adhering to dust particles and particulate matter), or as gases (like volatile organic compounds). Rivers will carry a number of solutes (nitrogen fertiliser, agraric run-off, remains of antibiotics, medication and hormones).

A third way to classify pollutants uses their **persistence** in the environment. Some pollutants are biodegradable (i.e., they will be mineralised by bacteria or otherwise assimilated in the metabolism of any of the organisms in the environment) and therefore will not continue to exist in the ecosystem for a long time, e.g. cooking waste, sewage and manure. Other pollutants dissipate spontaneously: heat, discharged with the cooling water of a power station; acids and bases, due to the buffering capacity and the large volume of the ocean in which they end up²; cyanides, produced in metallurgical industries, also dissociate and dilute quickly in seawater (with only the immediate neighbourhood of the discharge feeling negative effects of the poison). A third group of pollutants are conservative or persistent. Examples are: metal contaminations, radioactive sources, chlorofluorocarbons in the atmosphere, dioxins and pesticides. Even more so, apolar pollutants usually display a tendency to bioaccumulate, i.e. animals at higher trophic levels accumulate significantly higher levels of these chemical compounds (see 2.1.2).

Lastly, pollution can be classified as **point source or nonpoint source** pollution. Point source pollution can be traced back to a single, identifiable spot where the pollutant originated – for example, a sewage pipe from a company, the noise from a windmill or the leak of the Deep Horizon oil drilling platform. Nonpoint source pollution cannot be attributed to a specific location or time, and has a rather diffuse source. Examples comprise agricultural runoff, dust from strip mining, or urban storm water runoff. Nonpoint source pollution is the leading cause of water pollution in the United States today, with polluted agricultural runoff the most important form.

Grant Thornton—^{REALLY} a great place to work.

We're proud to have been recognized as one of Canada's Best Workplaces by the Great Place to Work Institute™ for the last four years. In 2011 Grant Thornton LLP was ranked as the fifth Best Workplace in Canada, for companies with more than 1,000 employees. We are also very proud to be recognized as one of Canada's top 25 Best Workplaces for Women and as one of Canada's Top Campus Employers.



Priyanka Sawant
Manager



Audit • Tax • Advisory
www.GrantThornton.ca/Careers



Grant Thornton
An instinct for growth™

© Grant Thornton LLP. A Canadian Member of Grant Thornton International Ltd



Type	Primary Source	Effect
Nutrients	Runoff approximately 50% sewage, 50% from forestry, farming, and other land use. Also, airborne nitrogen oxides from power plants, cars, etc.	<ul style="list-style-type: none"> - Promote algal blooms in coastal waters. - Decomposing algae depletes water of oxygen, killing other marine life. - Can spur algal blooms (red tides), releasing toxins that can kill fish and poison people.
Sediments	Erosion from mining, forestry, farming, and other land-use; coastal dredging and mining.	<ul style="list-style-type: none"> - Cloud water; impede photosynthesis below surface waters; clog fish gills. - Smother and bury coastal ecosystems. - Carry toxins and excess nutrients.
Pathogens	Sewage, livestock.	<ul style="list-style-type: none"> - Contaminate coastal swimming areas and seafood. - Cause cholera, typhoid and other diseases.
Alien Species	Several thousand per day transported in ballast water; also spread through canals linking bodies of water and fishery enhancement projects.	<ul style="list-style-type: none"> - Out-compete native species and reduce biological diversity. - Introduce new marine diseases. - Associated with increased incidence of red tides and other algal blooms, a problem in major ports.
Persistent toxins (PCBs, heavy metals, DDT, etc.)	Industrial discharge; waste-water discharge from cities; pesticides from farms, forests, home use, etc.; seepage from landfills.	<ul style="list-style-type: none"> - Poison or cause disease in coastal marine life, especially near major cities or industry. - Contaminate seafood. - Fat-soluble toxins that bio-accumulate in predators can cause disease and reproductive failure.
Oil	46% from cars, heavy machinery, industry, and other land-based sources; 32% from oil tanker operations and other shipping; 13% from accidents at sea; remaining sources include offshore oil drilling and natural seepage.	<ul style="list-style-type: none"> - Low-level contamination can kill larvae and cause disease in marine life. - Oil slicks kill marine life, especially in coastal habitats. - Tar balls from coagulated oil litter beaches and coastal habitat. - Oil pollution is down 60% from 1981.
Plastics	Fishing nets; cargo and cruise ships; beach litter; wastes from the plastics industry and landfills.	<ul style="list-style-type: none"> - Discarded fishing gear continues to catch fish. - Other plastic debris entangles marine life or is mistaken for food. - Plastics litter beaches and coasts and may persist for 200 to 400 years.
Radioactive substances	Discarded nuclear submarine and military waste; atmospheric fallout; industrial wastes.	<ul style="list-style-type: none"> - Create "hot spots" of radioactivity. - Can enter food chain and cause disease in marine life. - Accumulate in top predators and shellfish, which are eaten by people.
Thermal	Cooling water from power plants and industrial sites.	<ul style="list-style-type: none"> - Kill off corals and other temperature sensitive sedentary species. - Displace other marine life.
Noise	Supertanker, other large vessels and machinery.	<ul style="list-style-type: none"> - Can be heard thousands of kilometres away under water. - May stress and disrupt marine life.

Table 1-1. Types, sources, and effects of marine pollution.

Compiled by World Watch Institute. Taken from Sündermann (2007)

1.4 Sources

Overall, the pollution that ends up in the seas and oceans, originates from four distinct sources. As represented in Figure 1-1, the major part of all pollution comes from the land, either through run-off and discharges (via waterways; 44%) or through the atmosphere (33%). Only 12% of all pollution is due to maritime activity and shipping accidents. Dumping of garbage and sewage, as well as the consequences of offshore drilling and mining make up for the rest (resp. 10% and 1%).

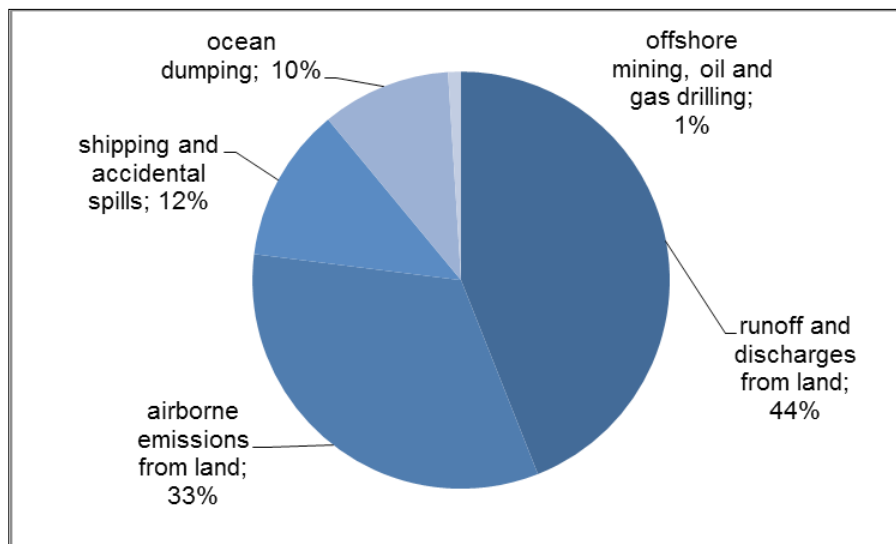

Figure 1-1. Share of the different sources of pollution into the marine environment (After IMO 2012)

1.4.1 Runoff from the land

The main transport of pollutants from the land to the sea occurs, evidently, through rivers. Rivers take up different forms of waste material from the land, which ends up in the oceans. The most direct load of pollutants comes from the urban and industrial sewage systems that are dumped in the rivers, often preceded by a sanitation step in a water sanitation installation (and even more often not).

This urban and industrial runoff, together with agraric run-off, also contains high levels of nitrogen and phosphorus. These two elements are essential for plant life (and in fact, for the establishment of any food chain in any ecosystem on the planet), but are often only present in the ocean in a limiting concentration to allow for abundant organismal growth. A constant influx of nutrient-rich water from the land can therefore upset any balance in the aquatic ecosystems in coastal areas. As the levels of nitrogen and phosphorus rise, the microalgae populations find themselves less and less restrained in their growth. This often results in so-called algal blooms: massive growth of the unicellular algae in the sea (see also 0, and both Figure 3-9 and Figure 3-11). When they die, the remaining biomass is mineralise by bacteria, which thereby consume so much oxygen that the water beneath these blooms becomes anaerobic. Any fish or invertebrate life there is bound to die. Hence, the so-called eutrophication due to the influx of nutrients is bound to cause severe distortion to the balance of the marine ecosystems.

A third source is the runoff from dust particles coming from metal ore and metal mines, washing away in the rivers. These metals can then wreak havoc with the normal metabolism of plant and animal life, as will be detailed in 2.9. According to the US Environmental Protection Agency (EPA), over 40% of watersheds in the western continental US have been contaminated with metals. A large proportion thereof ends up in the oceans.

Lastly, there are the large chunks of plastic that are being dumped along the coast, in rivers, etc.... Once they arrive in the ocean, they float along on the oceanic gyres which concentrates this kind of debris in the different oceans. This waste material is the main killer of life in the ocean and may take up to 450 years to be degraded.

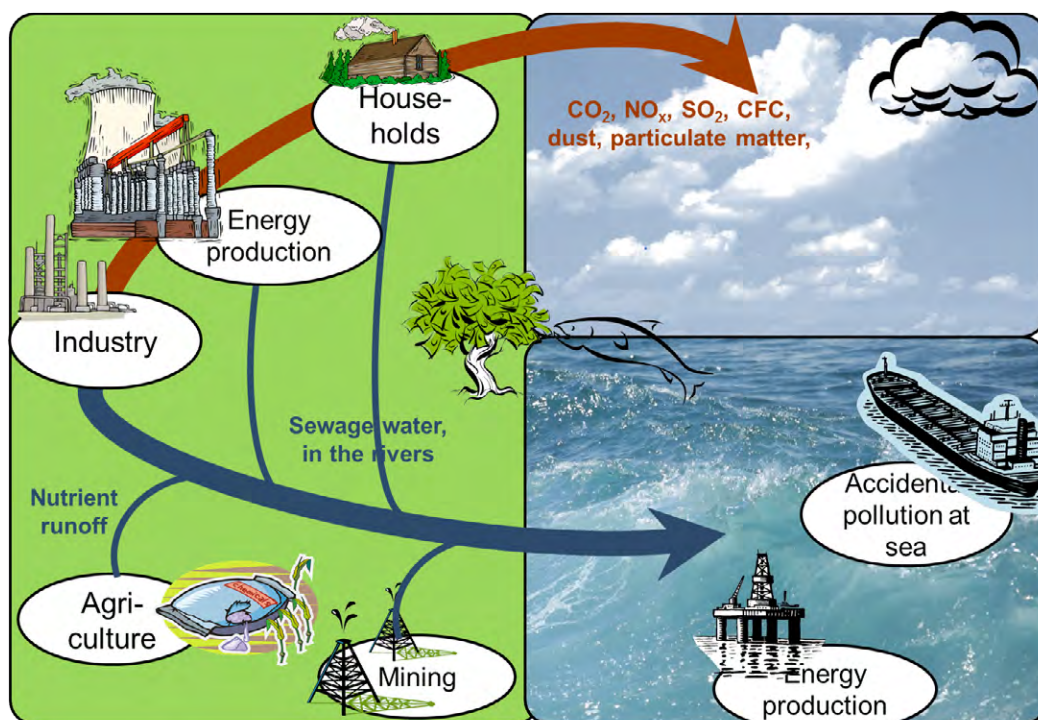

Figure 1-2. Inputs of pollution into the marine environment

1.4.2 Atmospheric pollution from the land

The atmosphere is another way for pollutants to reach the ocean. Lighter dust fractions and debris will be taken up by the wind and blown towards the ocean. A great number of dust particles will carry metal traces, which are spread out this way.

A second type of atmospheric pollution which affects the marine environment are the greenhouse gases, which, by warming the earth, also raise the temperatures in the oceans. A secondary consequence seems to be that the increased concentration of CO₂ in the atmosphere contributes to ocean acidification. This will be discussed in 3.2, p. 96. Thirdly, combustion processes (like car engines) produce a significant amount of SO₂ and NO_x as well. These will increase the occurrence of acid rain.

1.4.3 Ships

Shipping activity may pollute the atmosphere in two major ways (Figure 1-4): first of all, ship's engines as well as the incineration of garbage produce CO_2 , SO_2 and NO_x , which will add to global warming and acid rain formation (see Chapter 3). Furthermore, cooling systems may still be operating on freons and other chlorofluorocarbons, and occasionally some halon gases are still at hand for fighting specific fires. Their accidental release and subsequent escape of these gases to the stratosphere furthers the build-up of CFCs in the ozone layer and the degradation of the latter. It needs to be said, though: in many instances, these gases are being traded in for more environment friendly alternatives.

When it comes to the amount of pollution that goes into the water, it needs to be said that most of it is simply by accident. As we discuss in Chapter 6, Policy and pollution, there are a good number of international regulations that forbid express dumping of all different kinds of waste above certain levels. For example, garbage has to be either delivered to shore or burnt in incinerators onboard. Incineration is prohibited in special areas (MARPOL Annex V).

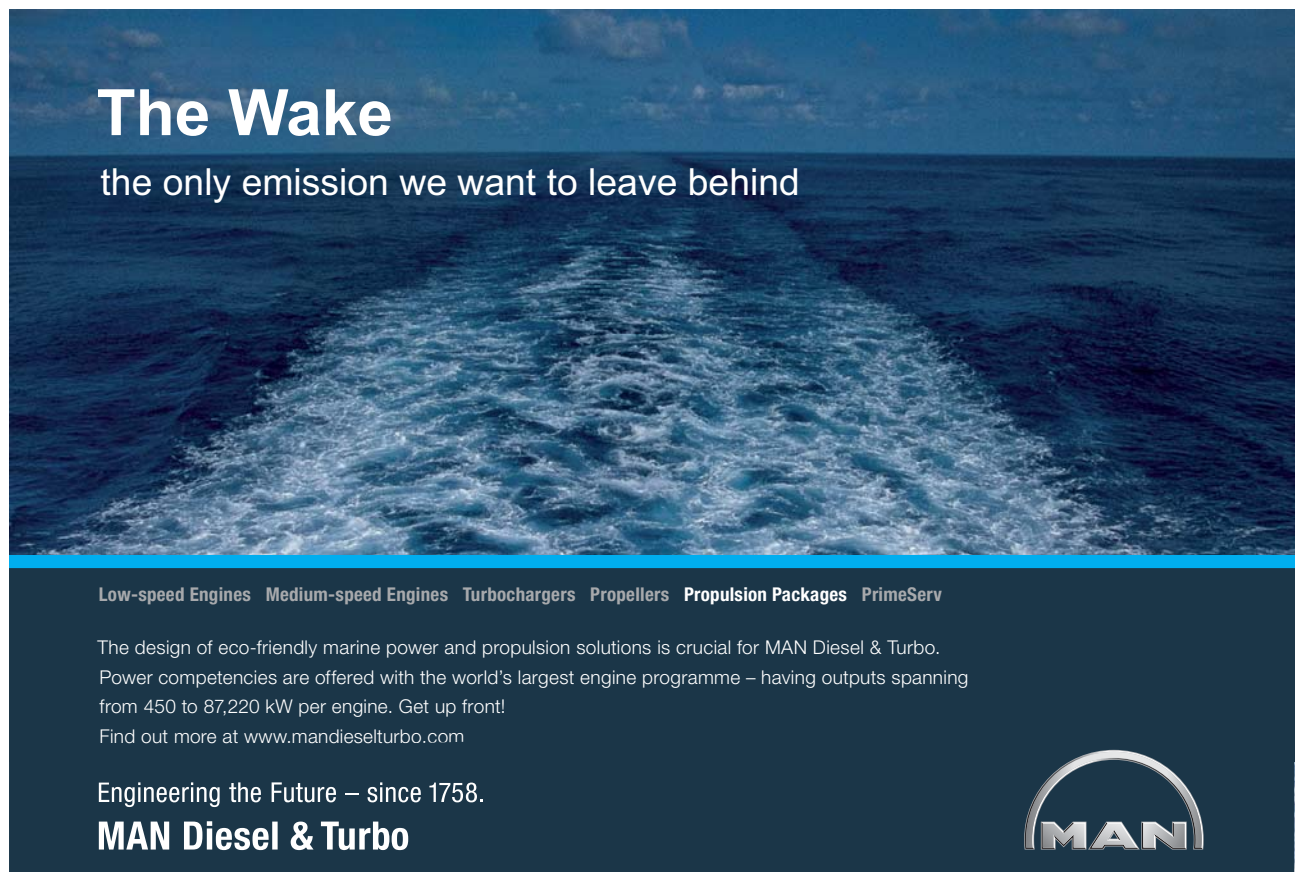

The Wake
the only emission we want to leave behind

Low-speed Engines Medium-speed Engines Turbochargers Propellers Propulsion Packages PrimeServ

The design of eco-friendly marine power and propulsion solutions is crucial for MAN Diesel & Turbo. Power competencies are offered with the world's largest engine programme – having outputs spanning from 450 to 87,220 kW per engine. Get up front!
Find out more at www.mandieselturbo.com

Engineering the Future – since 1758.
MAN Diesel & Turbo



The quantitatively largest aquatic form of accidental pollution (Figure 1-4) caused by the maritime sector is also the one that has been highlighted the most: oil spills. As crude oil consists of a wide range of different hydrocarbon molecules with different molecular weight and properties, it is not easy to give a concise view of the total damage that is done by an accidental spill. Apart from the highly visible heavy oil that covers the water, the animals and the shores, a large number of lighter components are present as well. These lighter components are likely to do even more damage in the long run, as they are stored in the adipose tissue of different animals in the food chain. Examples of these lighter components comprise the monocyclic and polycyclic aromatic hydrocarbons, which are difficult to clean up, and bound to cause cancer and other health problems after a few years of continuous exposure. We will discuss this in more detail in Chapter 4, Oil and organic pollution.

As people live on ships, a certain quantity of “grey water” (polluted sewage water) is being produced, in the kitchen, the showers.... Part of that goes overboard, as on the high seas, the oceans are able to deal with raw sewage through natural bacterial action. On the other hand, the regulations in Annex IV of MARPOL prohibit discharging sewage water within a certain distance of the nearest land, unless the ship is equipped with a certified installation .

One specific compartment, designed to capture all water that does not drain off over the side of the deck, is the bilge, the compartment directly above the keel. This water may be from rough seas, rain, minor leaks in the hull, or interior spillage. Bilge water can be found aboard almost every vessel. Depending on the ship's design and function, bilge water may contain water, oil, urine, detergents, solvents, chemicals, pitch, particles, and other materials. Cleaning out the bilge tank is therefore bound to release a quantity of pollutants. Customarily, there is a distinction between engine bilge and all the other forms of bilge water. Again, the International Maritime Organisation has imposed a number of strict rules to limit the impact of the shipping sector on the marine environment. In this case, no water exceeding 15 parts per million (ppm) of oil can be discharged overboard (MARPOL Annex I – see also 6.3.2).



Figure 1-3. Biofouling organisms.

Top: Left: Barnacle *Semibalanus balanoides* (Source: Kim Hansen, Wikipedia) – Right: Polychaete *Hermodice carunculata* (Source: NOAA). Bottom, Left: hydroid *Pennaria disticha* (Source: NOAA) – Right: Mollusc *Dreissena polymorpha* (the zebra mussel (Source: NOAA).

The risk for biological contamination is more tricky to contend with. To start with, when ballast water is taken up, it is bound to contain a number of microscopic life forms, such as algae and larval forms of invertebrates that belong to the specific region the ship resides in. When the ballast water is pumped out, possibly even after a few weeks, organisms may end up thousands of kilometres away from the region where they belong. Similarly, there are the organisms that attach themselves to the ship hull in a process called biofouling. Calcareous fouling organisms (protected by a calcium-enforced exoshell) include barnacles, bryozoans, molluscs, polychaetes and tube worms. Examples of non-calcareous (soft) fouling organisms are seaweed, hydroids, algae and bacterial biofilms. Together, these organisms form fouling communities on all kinds of maritime objects.

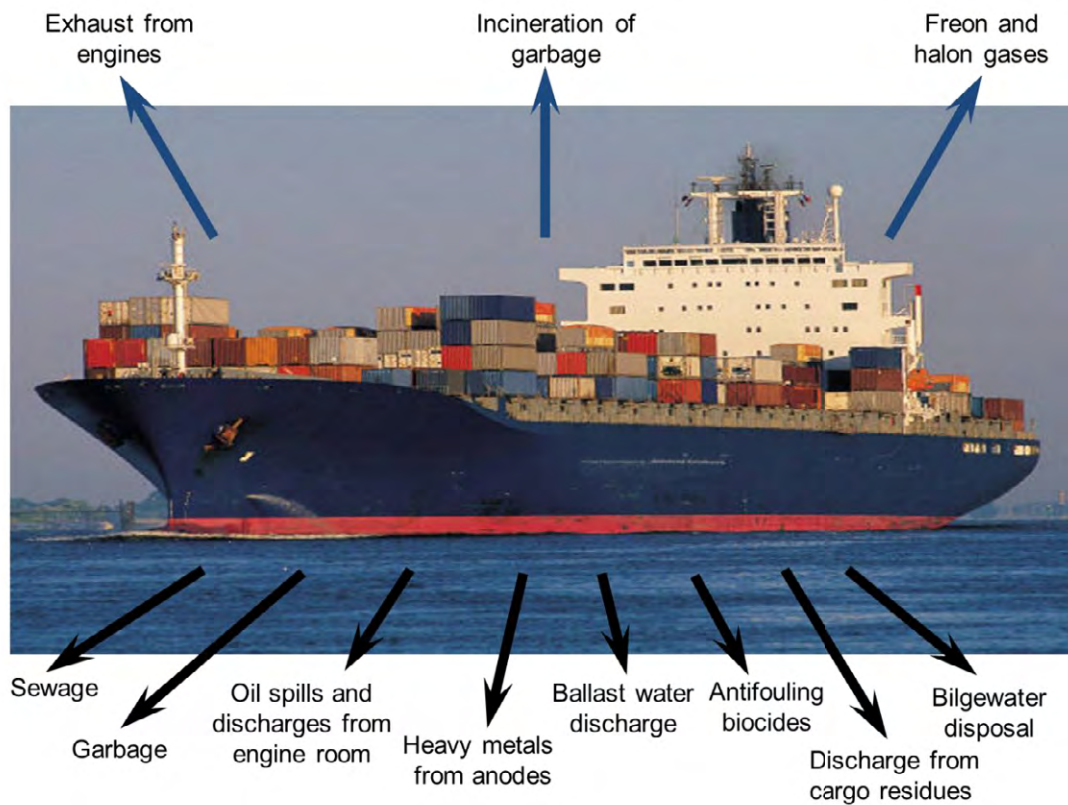

Figure 1-4. Pollution finds its way off the ship



CAREER KICKSTART

An app to keep you in the know

Whether you're a graduate, school leaver or student, it's a difficult time to start your career. So here at RBS, we're providing a helping hand with our new Facebook app. Bringing together the most relevant and useful careers information, we've created a one-stop shop designed to help you get on the career ladder – whatever your level of education, degree subject or work experience.

And it's not just finance-focused either. That's because it's not about us. It's about you. So download the app and you'll get everything you need to know to kickstart your career.

So what are you waiting for?

Click [here](#) to get started.



Roughly 90% of the species that are transported unknowingly does not survive the transition to a new habitat. The remaining 10% is able to stay alive and happens to be seen now and then. They cause no harm whatsoever. 1% of the transported species, however, is able to establish a firm presence in its new home. These are called exotic species, or, with a more popular term, “aquatic hitch hikers”. About 10% of these exotics even ends up threatening the normal ecological processes around them, chasing the local (endemic) organisms out of their habitat and niche, taking over the region, spreading new diseases, etc... These species are called invasive. They are allegedly responsible for more than \$120 billion in annual losses in the US alone (Pimentel et al. 2005).

The top ten of the most invasive species in marine ecosystems can be found on http://globallast.imo.org/poster4_english.pdf

On the other hand, prevention of biofouling presents an environmental danger in itself, to be found in the layers of paint and antifouling agents covering all sides of the ship. Many of these chemical mixtures contain biocides – products that are designed to kill the different sea organisms that try to attach themselves to the hull, thereby favouring corrosion or decreasing the hydrodynamic character of the ship. Over time, these biocides will dissolve from the paint matrix they were originally applied in, and end up in the sea. Similarly, there is the zinc and aluminium coming from corroding sacrificial anodes: blocks of a less noble metal installed in contact with the nobler steel hull of the ship to serve as galvanic protection. The zinc ions that dissolve from these anodes end up in the water surrounding the hull.

Lastly, there is the possibility that ships sometimes lose part of their cargo, due to human error, storm wind and waves. Some estimate that over 10,000 containers are lost accidentally at sea every year.



Figure 1-5. Imposex in dog whelks.

The dog whelk (*Nucella lapillus*) is used as an ecological indicator in the North Sea. Their population is greatly diminished due to containing TBT containing ship coatings, causing an imbalance of in the sex hormones, which resulted in the female genitalia changing into their male counterparts, so that the females could no longer reproduce. Source: Luis Miguel Bugallo Sánchez, Wikimedia.

1.4.4 Deep sea mining

A last source of pollution is deep sea mining. This process attempts to unearth the deposits of sulfides of important and precious metals (such as silver, manganese, copper, gold and zinc), which are often created near hydrothermal vents, at about 1400–3700 m below the ocean surface (Figure 1-6). The mining occurs with hydraulic pumps and buckets being taken up and down to reach the ores and transport them to the surface.

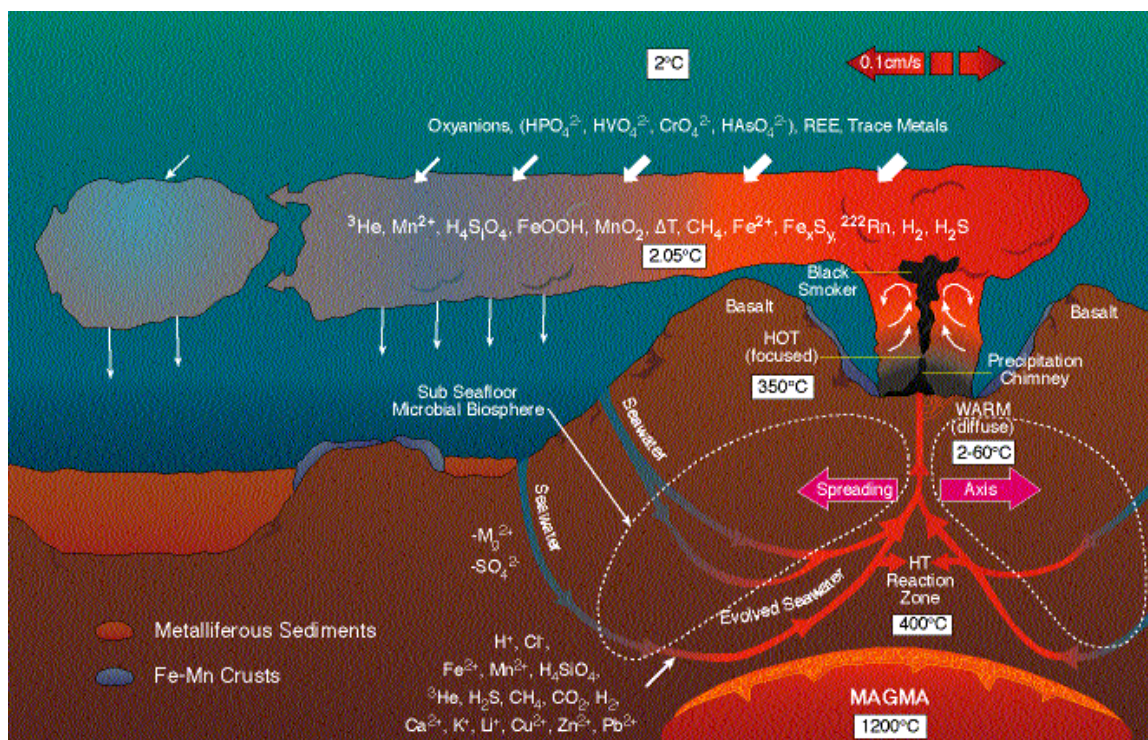

Figure 1-6. Hydrothermal circulation

This occurs when seawater penetrates into the ocean crust, becomes heated, reacts with the crustal rock, and rises to the seafloor. Seafloor hydrothermal systems have a major local impact on the chemistry of the ocean that can be measured in hydrothermal plumes. Some hydrothermal tracers (especially helium) can be mapped thousands of kilometres from their hydrothermal sources, and can be used to understand deep ocean circulation. Because hydrothermal circulation removes some compounds from seawater (e.g. Mg, SO_4^{2-}) and adds many others (He, Mn, Fe, H_2 , CO_2), it is an important process in governing the composition of seawater. (Source: <http://www.pmel.noaa.gov/vents/chemistry/information.html>)

It should not be surprising that nations and companies turn to the sea to enhance their metal production. Ore mining on land has been going on for decades, if not for centuries, and many mines are being overtaxed already, if not bordering on complete exhaustion. Moreover, the time seems right for an economically viable exploitation of the metal ores on the ocean floor: a lot of the necessary technology is available, reducing the risk and the initial investments to be made; e.g. cables to be laid at such a depth, diamond drills available from deep water oil and gas mining.... Also, metal prices are high and still rising, leading to a substantial and certified return on investment. And lastly, there is an apparent shift in focus from the international waters (and their highly regulated status) towards the exclusive economic zones, controlled by individual states (which are happy to share in the benefits).

One of these deep sea mining projects is Solwara 1. It is the first of a potentially large number of offshore mining projects within the Bismarck Sea and wider Pacific region. Applications were approved last year from firms registered in both Nauru and Tonga to explore the waters off Papua New Guinea, a high grade copper-gold resource and the world's first Seafloor Massive Sulphide resource. Solwara 1 focuses on mineral deposits laid down over thousands of years around underwater hydrothermal vents (geysers), known as seafloor massive sulphides. These deposits occur at depths of one to two kilometres, and can range in mass from several thousand to 100 million tonnes.

So far, with deep sea mining being a rather new technology, the ecological consequences are unknown (Glasby 2000, Yamazuki 2011). However, a number of concerns have already been raised:

- Digging up parts of the sea floor disturbs the benthic ecosystems close to the hydrothermal vents. These ecosystems are often teeming with life, containing many species that are unique to the vents and with a high primary production. The ecosystems surrounding hydrothermal vents combine superheated and highly mineralized vent fluids with microbes that are capable of using chemicals as a nutritional source. In recent years, such ecosystems have been found to host over 500 species previously unknown to science. In addition, damage to those ecosystems may impact large regions of the benthic zone in the oceans.
- Mining these deposits may result in leakage of the toxic sulfides, altering the composition of the water column.

ORACLE®

Be BRAVE

enough to reach for the sky

Oracle's business is information - how to manage it, use it, share it, protect it. Oracle is the name behind most of today's most innovative and successful organisations.

Oracle continuously offers international opportunities to top-level graduates, mainly in our Sales, Consulting and Support teams.

If you want to join a company that will invest in your future, Oracle is the company for you to drive your career!

<https://campus.oracle.com>



ORACLE®

ORACLE IS THE INFORMATION COMPANY



- Among the impacts of deep sea mining, sediment plumes could have the greatest impact. Plumes are caused when the tailings from mining (usually fine particles) are dumped back into the ocean, creating a cloud of particles floating in the water. Two types of plumes are distinguished: (1) seafloor plumes, which will affect the local turbidity and clog the feeding apparatus of the benthic organisms down below, and (2) surface plumes, which could affect light penetration in the water near the ocean surface, threatening primary production by the phytoplankton, and alter the chemical composition near the surface, affecting all planktonic life forms.

1.5 Read more?

Scientific literature

Ahnert, A., & Borowski, C. (2000). Environmental risk assessment of anthropogenic activity in the deep-sea. *Journal of Aquatic Ecosystem Stress and Recovery*, 7(4), 299–315.

Giurco, D., & Cooper, C. (2012). Mining and sustainability: asking the right questions. *Minerals Engineering*, 29, 3–12.

Glasby, G.P. (2000). Lessons learned from deep-sea mining. *Science*, 289(5479), 551–553.

Gold, T. (2001). *The deep hot biosphere: the myth of fossil fuels*. Springer. ISBN 0-387-95253-95255.

Halfar, J., & Fujita, R. M. (2002). Precautionary management of deep-sea mining. *Marine Policy*, 26(2), 103–106.

Halfar, J., Fujita, R.M. (2007). Danger of deep-sea mining, *Science* 316, 987–987.

Shusterich, K. (1982). Mining the deep seabed: A complex and innovative industry. *Marine Policy*, 6(3), 175–192.

Littleboy, A., & Boughen, N. (2007). *Exploring the social dimensions of an expansion to the seafloor exploration and mining industry in Australia: Synthesis Report*. North Ryde, Australia: CSIRO Wealth from Oceans Flagship.

Nath, B.N., & Sharma, R. (2000). Environment and deep-sea mining: A perspective. *Marine georesources & geotechnology*, 18(3), 285–294.

Pimentel, D., Zuniga, R., & Morrison, D. (2005). Update on the environmental and economic costs associated with alien-invasive species in the United States. *Ecological economics*, 52(3), 273–288.

Van Dover, C. (2000). *The ecology of deep-sea hydrothermal vents*. Princeton University Press. ISBN 0-691-04929-7.

Yamazuki, T. (2011). Impacts of up-coming deep-sea mining, In: Brunn SD (ed.), *Engineering Earth: The Impacts of Megaengineering Projects*, Springer Netherlands, pp. 275–295.

Websites

IMO (2012) International Shipping Facts and Figures – Information Resources on Trade, Safety, Security, Environment, <http://www.imo.org/KnowledgeCentre/ShipsAndShippingFactsAndFigures/TheRoleandImportanceofInternationalShipping/Documents/International%20Shipping%20-%20Facts%20and%20Figures.pdf>. Visited August 10, 2013.

Nautilus Minerals, The Solwara 1 Project – High Grade Copper and Gold. <http://www.nautilusminerals.com/s/Projects-Solwara.asp>. Visited November 3, 2012.

Saenz, A (2011). 10,000 shipping containers lost at sea each year...here's a look at one. <http://singularityhub.com/2011/04/05/10000-shipping-containers-lost-at-sea-each-year-heres-a-look-at-one-2/>. Visited November 3, 2012.

Scarce, C. (2006). Hydrothermal Vent Communities, CSA Discovery Guides, <http://www.csa.com/discoveryguides/vent/review.pdf>. Visited November 3, 2012.

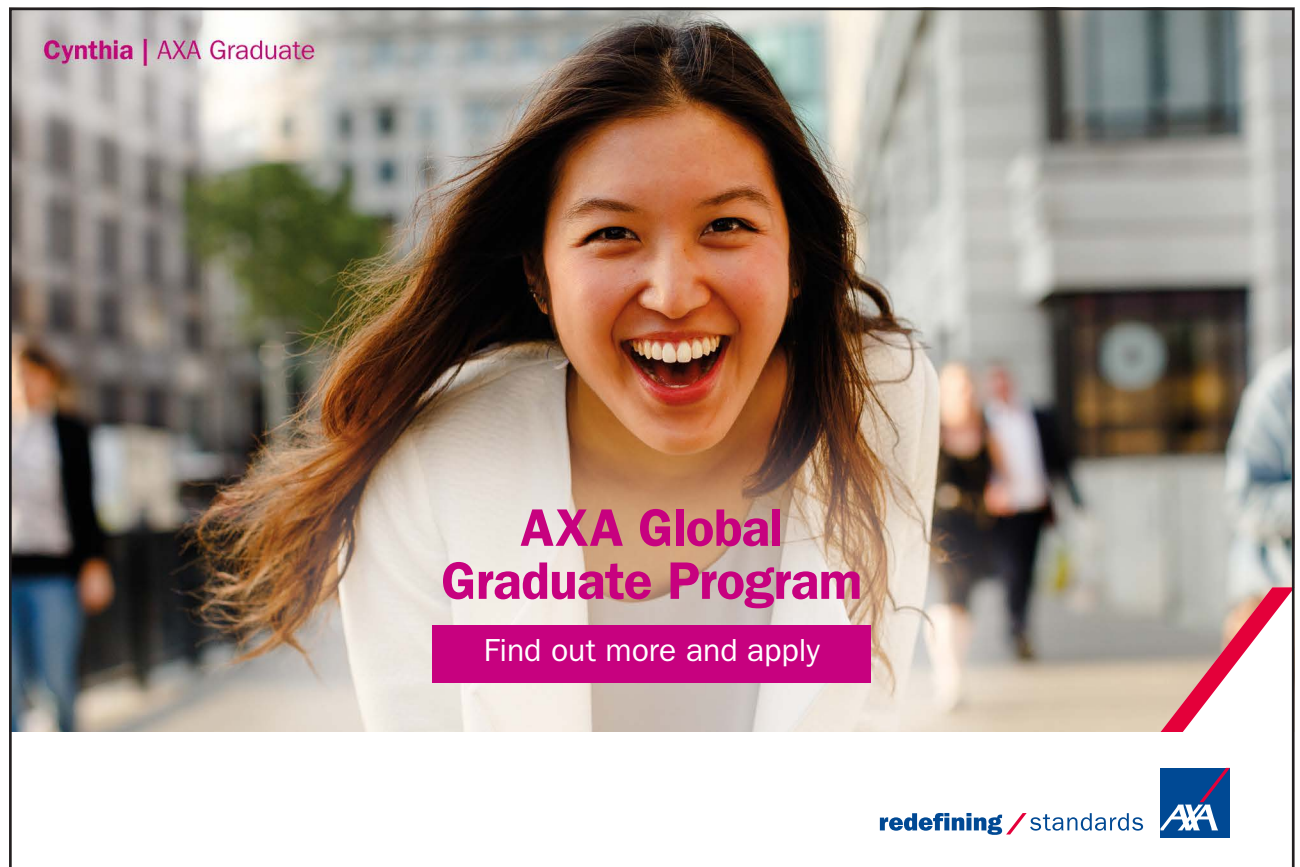

Cynthia | AXA Graduate

AXA Global Graduate Program

Find out more and apply

redefining / standards AXA

2 How to measure pollution

2.1 Measuring pollution is more difficult than you think

The basis of any analysis is a good set of solid measurements. When scientists wish to obtain a good insight into matters of pollution, the first thing they will do, is organise a measuring campaign. To design an effective measuring campaign about pollution, however, a number of questions need to be answered. The same goes for the people who need to interpret the published results of the research of others.

2.1.1 Measuring – what are we going to measure?

The most straightforward measurements, and probably the first to be collected in every study, are **concentrations** of a given pollutant in the environment (the atmosphere, the soil or the seawater). Concentrations can be expressed in different ways.

aquatic	M, mol/L	moles of a substance per L of water
	mg/L	mg of a substance per L of water
terrestrial	mg/kg	mg of substance per kg of soil
atmospheric	ppm	molecules per million of air particles
	mg/m ³	mg of substance per cubic m of air

Apart from the actual concentration, it may be useful to know how fast a substance is degraded in this environment: this is called the **persistence** of a pollutant. A convenient way to express this, is the half-life of a pollutant (i.e. the time for half of a certain quantity of the compound to disappear from the environment). Of course, it is also useful to look at what is left of the original pollutant. Many substances may be degraded, either chemically (due to solar radiation or heat) or biologically (mostly due to bacteria and fungi), but the molecules that are formed as intermediates or end products of this degradation process may be equally toxic for the environment.

However, pollutants can undergo a number of physicochemical transformations, and not every form of every substance is easily taken up by living cells. The extent to which a pollutant exists in a form that is accessible by living tissue, is called its **bioavailability**.

Figure 2-1 gives a good overview of what may be happening with a specific amount of a pollutant in an aquatic ecosystem. To start with, the pollutant may be present in the wrong chemical form to be taken up. It may be adsorbed to the surface of soil or sediment particles, in solution or in a precipitate with another compound. Lightweight compounds such as chloroform may be volatile enough to escape the water phase. A number of substances are chemically unstable under the given conditions and break down spontaneously, or become oxidised. Others will be broken down by the organisms in the ecosystem (biotransformation) or rendered harmless through a complexation with certain molecules of biological origin (e.g. metallothioneins, proteins that are able to form complexes with heavy metals).

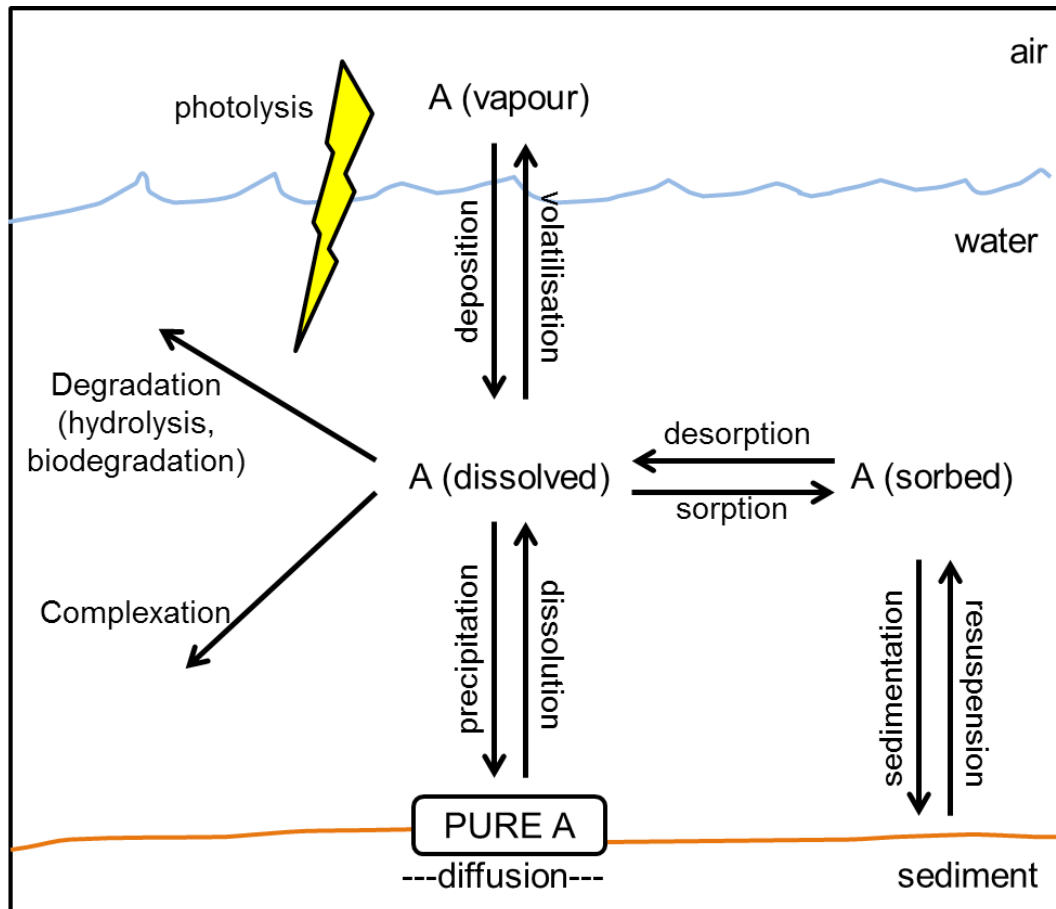

Figure 2-1. Processes influencing the availability of a chemical compound in an ecosystem.

Apart from the degradation pathways, each of these transformations follows the laws of dynamic equilibrium. Different constants (specific for each individual pollutant) can be used to describe them, e.g.:

- Solubility constant for the equilibrium between the solid and the dissolved phase
- Vapour pressure for the equilibrium between a liquid in solution and its gaseous state above the liquid
- Adsorption coefficient for the sorption/desorption equilibrium with sediments and suspended particles
- The octanol/water partition coefficient for the distribution between a water phase and an organic solvent.

A typical example are the different forms of metal ions, formed in a complex medium such as soil or seawater. As any chemical textbook will explain, both solubility and complex formation of ions are chemical equilibrium reactions, which are strongly or subtly influenced (depending on the specific reaction) on the pH and the other ionic constituents of the mix. As such, different combinations of ions can become prevalent in any complex mixture when the environmental conditions change (see Table 2-1 and). This is called **ionic speciation**. For elaborate mixtures, with many constituents, specific computer programs (PhreeqC, HySS,...) are needed to deal with the numerous equilibriums settling in simultaneously.

Reaction	log K at 25°C
$\text{Hg}(\text{OH})_2 + \text{Cl}^- + 2\text{H}^+ \rightleftharpoons \text{HgCl}^+ + 2\text{H}_2\text{O}$	12.85
$\text{Hg}(\text{OH})_2 + 2\text{Cl}^- + 2\text{H}^+ \rightleftharpoons \text{HgCl}_2 + 2\text{H}_2\text{O}$	19.22
$\text{Hg}(\text{OH})_2 + 3\text{Cl}^- + 2\text{H}^+ \rightleftharpoons \text{HgCl}_3^- + 2\text{H}_2\text{O}$	20.12
$\text{Hg}(\text{OH})_2 + 4\text{Cl}^- + 2\text{H}^+ \rightleftharpoons \text{HgCl}_4^{2-} + 2\text{H}_2\text{O}$	20.53
$\text{Hg}(\text{OH})_2 + \text{H}^+ \rightleftharpoons \text{HgOH}^+ + 2\text{H}_2\text{O}$	2.70
$\text{Hg}(\text{OH})_2 + \text{H}_2\text{O} \rightleftharpoons \text{Hg}(\text{OH})_3^- + \text{H}^+$	15.00
$\text{Hg}(\text{OH})_2 + 2\text{HS}^- \rightleftharpoons \text{HgS}_2^{2-} + 2\text{H}_2\text{O}$	31.24
$\text{Hg}(\text{OH})_2 + 2\text{HS}^- + 2\text{H}^+ \rightleftharpoons \text{Hg}(\text{HS})_2 + 2\text{H}_2\text{O}$	43.82
$\text{Hg}(\text{OH})_2 + \text{SO}_4^{2-} + 2\text{H}^+ \rightleftharpoons \text{HgSO}_4 + 2\text{H}_2\text{O}$	7.49

Table 2-1. Examples of the speciation of mercury(II)hydroxide and the associated equilibrium constant for each reaction.

Metal	concentration metal ([M])	concentration ligand ([L])	log K_{ML}
Cu(II)	1–10 nmol L ⁻¹	2–60 nmol L ⁻¹	8.5
Zn(II)	0.1–2 nmol L ⁻¹	1.2 nmol L ⁻¹	12
Cd(II)	2–800 pmol L ⁻¹	100 pmol L ⁻¹	12
Pb(II)	17–49 pmol L ⁻¹	200–500 pmol L ⁻¹	11
Ni(II)	1.7–4.3 nmol L ⁻¹	2–4 nmol L ⁻¹	17–19
Co(II)	10–103 pmol L ⁻¹	9–83 nmol L ⁻¹	11–16
Fe(III)	0.2–8 nmol L ⁻¹	0.4–1.3 nmol L ⁻¹	19–23

Table 2-2. Dissociation constants of metal organic complexes in seawater (after Millero and Pierrot 2001, and references quoted therein).

The general equation for each individual equilibrium between a metal M and its ligands L is

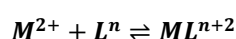

and the definition of the equilibrium constant becomes

$$K_{ML} = \frac{[ML^{n+2}]}{[M^{2+}] \cdot [L^n]}$$

Example

One interesting chemical contaminant is arsenic (As). This element can occur in four different oxidation states: arsenate (AsO_4^{3-} , with oxidation state V), arsenite (AsO_3^{3-} , with oxidation state III), the metal itself (oxidation state 0) and arsine (oxidation state – III). The phytoplankton will easily absorb the arsenate (given its chemical similarity to the essential ion phosphate, PO_4^{3-}), and reduce it to its trivalent oxidation state.

The bioavailability of As depends on its speciation (which in turn depends mostly on the concentration of Fe, Mn, Al and P ions), the density and activity of the phytoplankton, the temperature and the pH of the water, and the amount of dissolved oxygen (and thus the oxidation state).

For more information, see the review on arsenic by Azizur Rahman et al. (2012).

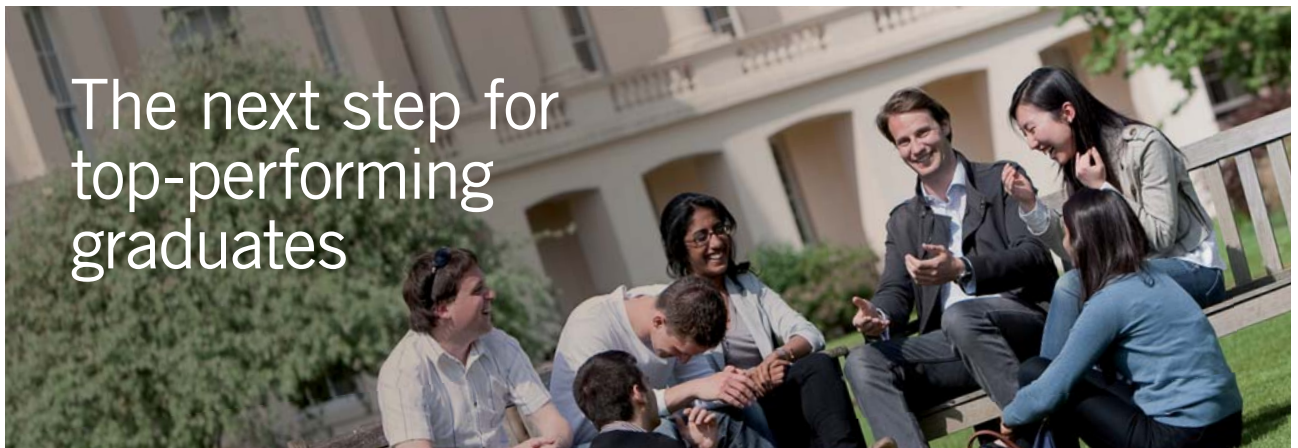

Masters in Management



Designed for high-achieving graduates across all disciplines, London Business School's Masters in Management provides specific and tangible foundations for a successful career in business.

This 12-month, full-time programme is a business qualification with impact. In 2010, our MiM employment rate was 95% within 3 months of graduation*; the majority of graduates choosing to work in consulting or financial services.

As well as a renowned qualification from a world-class business school, you also gain access to the School's network of more than 34,000 global alumni – a community that offers support and opportunities throughout your career.

For more information visit www.london.edu/mm, email mim@london.edu or give us a call on +44 (0)20 7000 7573.

* Figures taken from London Business School's Masters in Management 2010 employment report



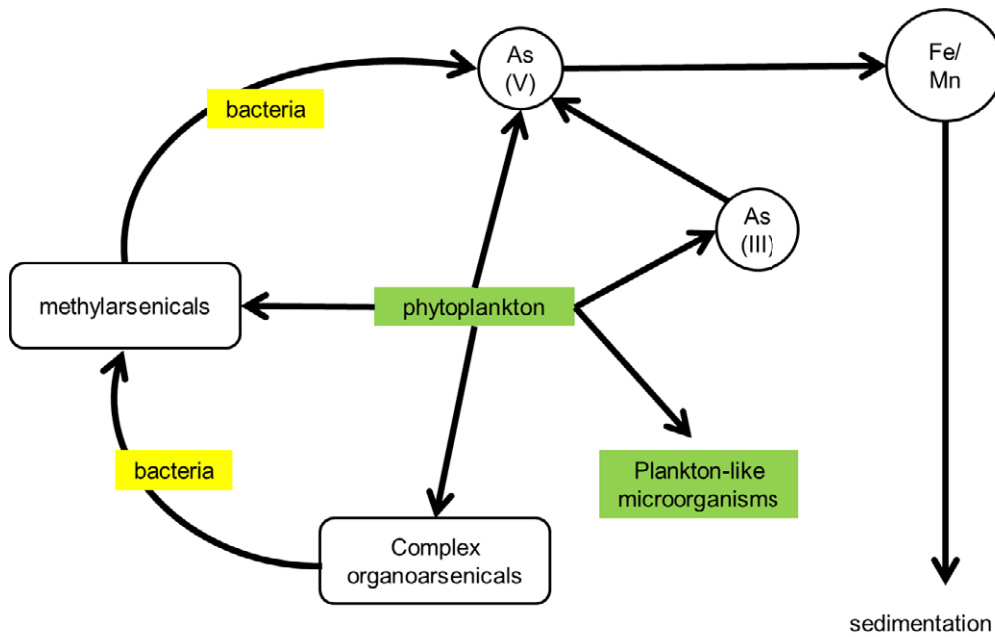

Figure 2-2. Several physicochemical and biological transformations of As in a marine ecosystem (after Azizur Rahman et al. 2012).

For easy identification of the typical properties of several important chemicals (often transported on board of chemical tankers and container ships) the Group of Experts on the Scientific Aspects of Marine Environmental Protection (GESAMP, under the control of the International Maritime Organisation) has devised a classification code, and a procedure for the fast evaluation of the hazards linked with each of these compounds. This system is presented in **Error! Reference source not found.**

Columns A & B - Aquatic environment						
Numerical rating	A Bioaccumulation and biodegradation			B Aquatic toxicity		
	A1 Bioaccumulation		A2 Biodegradation	B1 Acute toxicity LC/EC/IC50 (mg L ⁻¹)	B2 Chronic toxicity NOEC (mg L ⁻¹)	
	log Pow	BCF				
0	< 1 or ca. 7	not measurable	R: readily biodegradable NR: not readily biodegradable	> 1000	> 1	
1	≥ 1 - < 2	≥ 1 - < 10		> 100 - ≤ 1000	> 0.1 - ≤ 1	
2	≥ 2 - < 3	≥ 10 - < 100		> 10 - ≤ 100	> 0.01 - ≤ 0.1	
3	≥ 3 - < 4	≥ 100 - < 500		> 1 - ≤ 10	> 0.001 - ≤ 0.01	
4	≥ 4 - < 5	≥ 500 - < 4000		> 0.1 - ≤ 1	< 0.001	
5	≥ 5	≥ 4000		> 0.01 - ≤ 0.1		
6			< 0.01			
Columns C & D - Human health (toxic effects to mammals)						
Numerical rating	C Acute mammalian toxicity			D Irritation, corrosion and long term health effects		
	C1 Oral toxicity LD50 (mg kg ⁻¹)	C2 Dermal toxicity LD50 (mg kg ⁻¹)	C3 Inhalation toxicity LC50 (mg L ⁻¹)	D1 Skin irritation and corrosion	D2 Eye irritation and corrosion	D3 Long-term health effects
0	> 2000	> 2000	> 20	not irritating	not irritating	C: carcinogen M: Mutagenic R: reprotoxic S: Sensitising A: Aspiration hazard T: target organ Systemic toxicity L: Lung injury N: Neurotoxic I: Immunotoxic
1	> 300 - ≤ 2000	> 1000 - ≤ 2000	> 10 - ≤ 20	mildly irritating	mildly irritating	
2	> 50 - ≤ 300	> 200 - ≤ 1000	> 2 - ≤ 10	irritating	irritating	
3	> 5 - ≤ 50	> 50 - ≤ 200	> 0.5 - ≤ 2	severely irritating or corrosive 3A: Corr. (≤ 4h) 3B: Corr. (≤ 1h) 3C: Corr. (≤ 3 min)	severely irritating	
4	≤ 5	≤ 50	≤ 0.5			
Column E - Interference with other uses of the sea						
E1 Tainting	E2 Physical effects on wildlife and benthic habitats		E3			
			Numerical rating	Interference with coastal amenities		
T: tainting test positive NT: not tainting (tested)	FP: Persistent floater		0	no interference – no warning		
	F: Floater		1	slightly objectionable – warning, no closure of amenity		
	S: Sinking substances		2	moderately objectionable – possible closure of amenity		
			3	highly objectionable – closure of amenity		

Table 2-3 GESAMP evaluation system for hazardous chemicals

2.1.2 Measuring – at what trophic level?

In addition, not every chemical substance is present at every level in the food chain to the same extent. The first step in the internalisation of a pollutant into an organism is called the **bioconcentration** step: organisms take up a pollutant because they ingest the water they live in. Quantitatively speaking, this is the ratio between the concentration found in the surrounding water and the concentration in the organisms that take up this pollutant directly from the water.

$$F_c = \frac{\text{concentration in organism}}{\text{concentration in water}}$$

F_c depends directly upon K_{ow} , the partition coefficient of a compound between the octanol and water phases, also serving as a measure for the lipophilicity of a compound³.

$$F_c = a \cdot \log K_{ow} + b$$

Organisms can also take up a certain pollutant by eating other organisms (their prey) which have already internalised the compound. This is called **biomagnification**, and is calculated as follows:

$$F_m = \frac{\text{concentration in organism}}{\text{concentration in prey}}$$



Get Internationally Connected at the University of Surrey

MA Intercultural Communication with International Business
MA Communication and International Marketing



MA Intercultural Communication with International Business
Provides you with a critical understanding of communication in contemporary socio-cultural contexts by combining linguistic, cultural/media studies and international business and will prepare you for a wide range of careers.

MA Communication and International Marketing
Equips you with a detailed understanding of communication in contemporary international marketing contexts to enable you to address the market needs of the international business environment.

For further information contact:
T: +44 (0)1483 681681
E: pg-enquiries@surrey.ac.uk
www.surrey.ac.uk/downloads



Water-soluble components will be taken up into the bloodstream and (partially or fully) filtered out by the kidneys. However, some of the pollutant, especially the lipophilic compounds, will end up preferentially in the adipose storage tissue. If the rate of excretion of a compound is lower than its rate of uptake, the concentration of such a compound will rise during the life of one organism; moreover, when this organism will be predated on by another animal, ranked higher in the food chain, this new predator will ingest a much higher dose of the pollutant than its prey previously had. Consequentially, concentrations of pollutants will rise throughout the food chain (see Figure 2-3). Even rather harmless components (in small concentrations) may have a serious impact on the top predators in a given ecosystem.

The sum of bioconcentration and biomagnification is called the **bioaccumulation** of a certain compound. This can be expressed by the BioAccumulation Factor (BAF). For example, Giusti and Zhang (2002) report As concentrations of between 1 and 4.7 $\mu\text{g L}^{-1}$ in the water of the Venetian lagoon, Italy, of 12–18 $\mu\text{g g}^{-1}$ dry weight in the soft tissues of *Mytilus galloprovincialis*, and 0.4–2.7 $\mu\text{g g}^{-1}$ in its shell. This leads to a BAF of between 383 and 12 000 for As and for this bivalve species.

Another example – the bioaccumulation factor for methylmercury from the surrounding water by phytoplankton is 10^5 ; for macroorganisms like zooplankton and planktivores, the BAF is about one million, and for piscivores like fish, birds and humans, it is about ten million. A third example (about the insecticide DDT) has been presented in Figure 2-4.

Conclusion: measuring the concentration of a pollutant in the water is not enough to assess the impact of this pollutant upon the ecosystems in the water. One needs to see which compounds are being taken up, and to what extent.

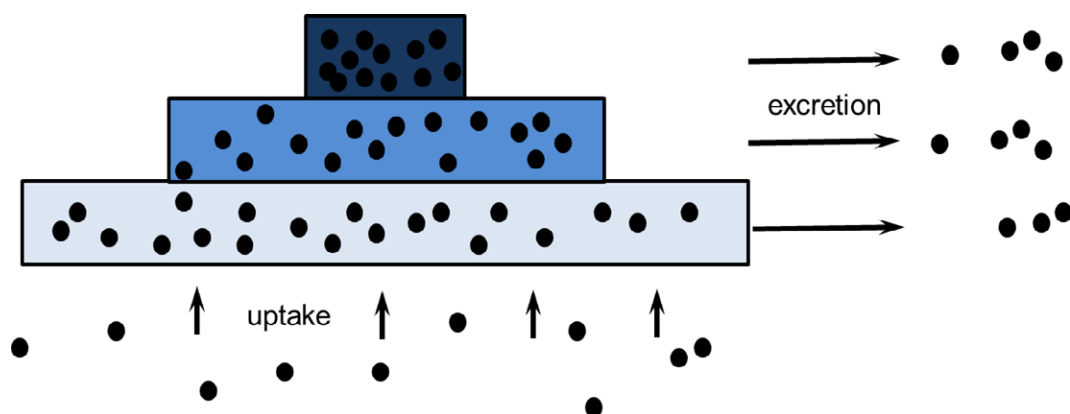

Figure 2-3. Schematic representation of the process of biomagnification

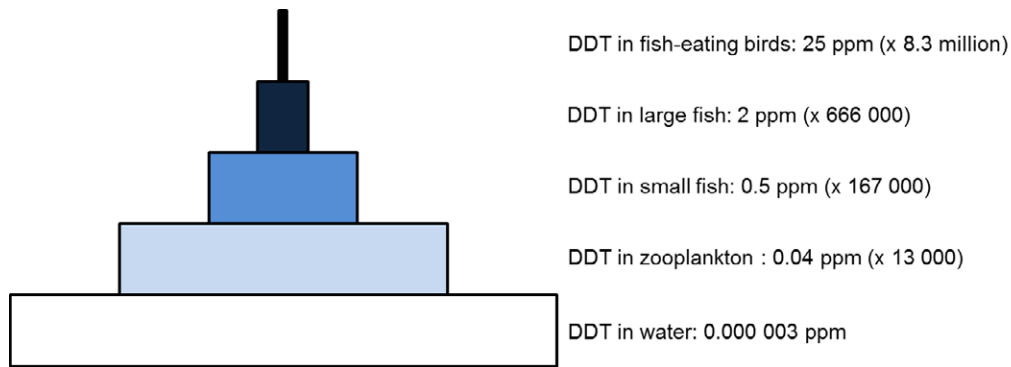

Figure 2-4. Biomagnification of DDT in an aquatic food chain

An interesting way to compare different organisms with respect to their position in the food chain, is the use of stable isotopes of nitrogen. Apparently, when predators consume their prey, they take up preferentially the ^{15}N isotopes. Consequentially, organisms on a higher trophic level accumulated higher levels of ^{15}N relative to their prey and others before them in the food web.

By standardising the ^{15}N content of the tissue of an organism relative to its ^{14}N content and an external standard, $\delta^{15}\text{N}$ (the enrichment in ^{15}N) is calculated:

$$\delta^{15}\text{N} = \left[\frac{\left(\frac{^{15}\text{N}}{^{14}\text{N}} \right)_{\text{sample}}}{\left(\frac{^{15}\text{N}}{^{14}\text{N}} \right)_{\text{standard}}} - 1 \right] \cdot 1000\text{‰}$$

In a standard marine food chain, there is apparently a 3.2‰ enrichment of ^{15}N from prey to predator (Michener and Kaufman 2007, Michener and Lajtha 2007). Additionally, a graph where $\delta^{15}\text{N}$ is used as explanatory variable versus a pollutant, can be used to show how this pollutant accumulates throughout the different trophic levels in that ecosystem (see Figure 3-22).

As an aside – apparently, biomagnification is not a given outcome when a specific pollutant is present in an ecosystem. Table 2-4 gives an overview of several studies on different typical marine pollutants and whether they cause biomagnification upon entrance in the food chain. For all of the pollutants, there are cases where no biomagnification has been. How and why this is, requires further investigation.

Compound	Number of papers	% Showing biomagnification
Mercury (Hg)	14	42
Other metals	14	0
PCB	35	54
Tributyl tin (TBT), Butyl tin (BT)	7	28
DDT and DDE	6	67
PAHs	2	0

Table 2-4. Variation in biomagnification studies
Taken from Gray (2002)

2.1.3 Measuring: at which level?

As we will discuss at length further on in this text, the impact of pollution can be felt on many different levels. This means that a researcher will need to determine on which scale he wants to perform his research.

The most direct effects are evidently felt on the level of the individual cell, due to the direct interaction of the pollutant with proteins or DNA. This may cause changes in gene expression and whole cell metabolism; given that never a single cell alone is affected, whole tissues or organs are probably influenced in a similar way. This will of course have an impact on the health of the whole organism, and likely of that of several others in the same population or (when different organisms in different species are affected) in the same community.

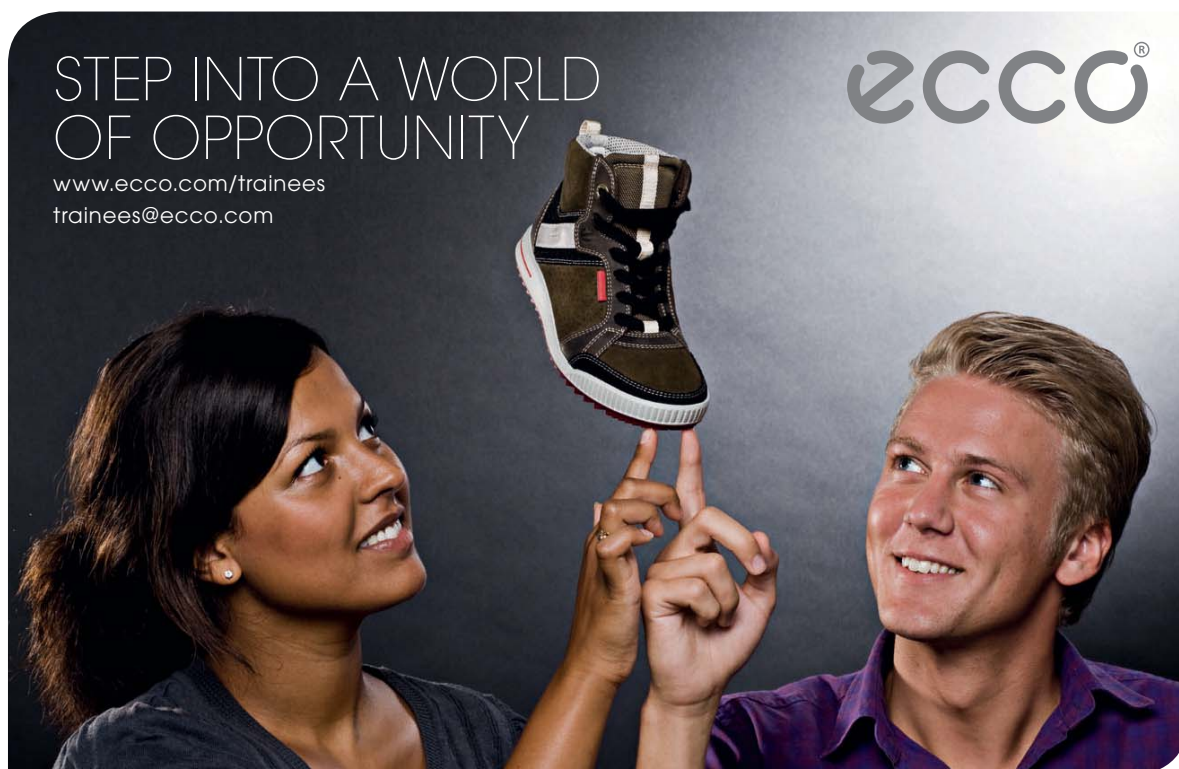

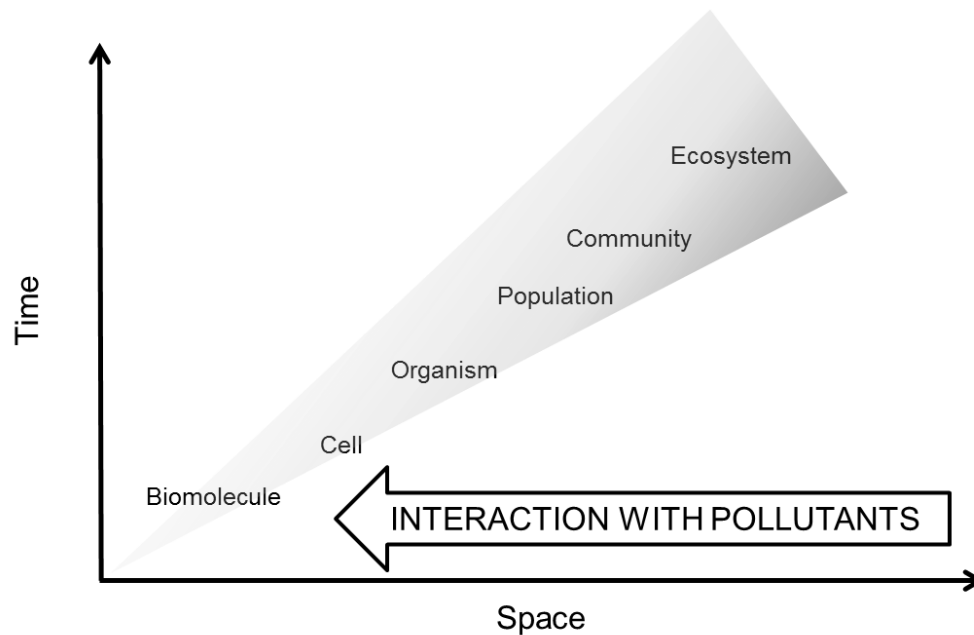

Figure 2-5. The different biological hierarchical levels of impact of a pollutant

As such, changes can be felt on very different scales: first of all, on a size scale, going from cells (of several micrometre wide) to ecosystems (measuring up to kilometres wide). The time delay between exposure and the actual consequence on these different levels will change too, with changes on the cellular level being felt within seconds or minutes after exposure, while it may take months or even years before the effect of a pollutant on ecosystems can be demonstrated. At the same time, measuring changes at the level of cells and organs are done rather quickly and give a lot of mechanistic biochemical information, while ecosystem changes will have to be dealt with in a more vague way, and require more time, effort and money to be investigated. On the other hand, it is mostly the effects on population, community and ecosystem scale that will cause the most problems on the human scale: humans will be affected by these levels of pollution either directly or indirectly, because of the impact of the pollution on our land use, nature reserves, quality of life.... The large scales may be difficult to quantify and to study, but they are the most relevant for our own wellbeing, health or possibly survival, and once we notice the effect of a pollutant on the ecological level, a lot of damage has already been done.

2.2 Measuring toxicity the classical way

2.2.1 It's all in the dosage

Traditionally, the impact of a chemical substance on life in an ecosystem is measured using toxicological tests. Toxicology is the study of poisons: their nature, the way they function, their effects, the ways to trace them, treat them or at least alleviate their symptoms,... Poisons are all kinds of chemical compounds with a toxic effect (such as benzene, arsenic or mercury); toxins are poisons produced by another organism (plants, animals, bacteria, fungi), such as cobra venom, botulism toxin and cholera toxin.

The father of the modern toxicology is Paracelsus (1493–1541). He developed the key insight that all chemical compounds are capable to harm the human body, and that the only difference lies in the amount that is ingested:

*“Alle Ding sind Gift, und nichts ohn Gift;
allein die Dosis macht, das ein Ding kein Gift ist.”*

Translated, this means “Everything is a poison, and nothing is not a poison; only the dosage decides that a substance is not poisonous in its effects”. Indeed, some toxic compounds may have beneficial effects in small dosages (consider most medication), and even water and sugar, which are generally accepted as harmless, can kill a person.

A dosage of a compound is a quantity of this compound (expressed in g or mg per kg of body mass and per day) that is given at a specific moment to an organism. To assess the effect of a compound, one needs also to know:

- the number of doses an organism has been exposed to;
- how often this organism has been exposed to this dose.
- age and body mass of the organism that has been exposed.

2.2.2 Indicators of toxicity: LD_{50} , NOAEL, TLV

To assess the toxic nature of a substance, we need to determine the lethality of a compound. This is expressed as the so-called median lethal dose or LD_{50} : the individual dose that will kill 50% of a population of test animals. Knowing the LD_{50} of a number of toxic compound, we can compare their relative toxicity: the lower the LD_{50} , the more toxic the compound. Typically, the LD_{50} is expressed as mg of the toxic compound per kg of body weight of the test animal. Alternatively, the LC_{50} is used, which gives the amount of toxin (in mg) in 1 L of test solution.

Example: when a person of 80 kg ingests 3200 mg of a poison with an LD_{50} of 40 mg/kg, he has a 50% probability to die in a short time.

The LD_{50} was originally set up in 1927 by Trevan. It was further standardised by the Organisation for Economic Co-operation and Development (OECD) in as follows:

“In this test, the test substance is typically administered by oral gavage to fasted young adult animals (five animals per sex). The guideline calls for a minimum of three dose levels in the toxic/lethal range; generally, however, the test typically included at least five dose levels to ensure adequate data for calculating an LD50. For test substances with no information regarding their potential for acute oral toxicity, a range-finding or sighting study of up to five animals could be conducted to identify the range of lethal doses. In such situations, at least 30 animals per sex are utilized in each test.” (ICCVAM. 2001)

When test populations of a typical organism for toxicological tests (Figure 2-6) are exposed to a single (acute) dose of the poison, they are followed for a prescribed amount of time (two weeks at most), and the percentage of dead animals are graphed in relation to the dose they were exposed to, a graph such as in Figure 2-7 appears.



Figure 2-6. Typical test organisms in a toxicological test.
 From left to right: *Daphnia*, the zebra fish *Danio rerio*, the lab mouse *Mus musculus*.
 Source: *Daphnia*: Gewin V, *Functional Genomics Thickens the Biological Plot*. *PLoS Biology* Vol. 3/6/2005, e219. Zebra fish: Azul, Wikipedia.

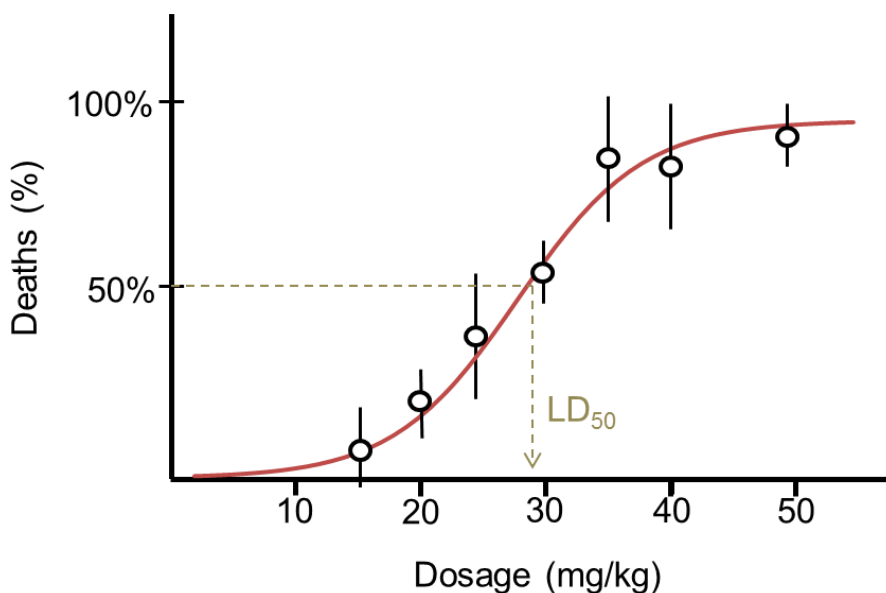

Figure 2-7. The position of the LD50 or median lethal dose on a toxicity curve

The LD₅₀ is only valid for the animal with which the original tests were performed, and depends upon the method of exposure (orally, inhalation, by application on the skin). An LD₅₀ for oral exposure is usually lower than the one for dermal exposure. On top of that, the LD₅₀ may even vary with the solvent in which the dose has been dissolved, or the gender of the test animal. Finally, the damage a poison can do depends upon the existence of a good antidote. Ethylparathione has an LD₅₀ of 3.6 mg/kg, but due to the good antidote against this substance, it is less dangerous than paraquat (with an LD₅₀ of 236 mg/kg), for which there is no cure.

The LD₅₀ now allows for further comparison and classification of poisonous compounds. We already mentioned the GESAMP classification system (**Error! Reference source not found.**), but there are a number of less complicated ones. For example, there is the scale of Gosseling, Smith and Hodge:

Oral dosage, probably lethal for humans:

Up to 5 mg/kg	Super toxic
From 5 to 50 mg/kg	Extremely toxic
From 50 to 500 mg/kg	Very toxic
From 500 to 5 000 mg/kg	Moderately toxic
From 5 000 to 15 000 mg/kg	Slightly toxic
From 15 000 mg/kg	Very slightly toxic

As a leading technology company in the field of geophysical science, PGS can offer exciting opportunities in offshore seismic exploration.

We are looking for new BSc, MSc and PhD graduates with Geoscience, engineering and other numerate backgrounds to join us.

To learn more our career opportunities, please visit www.pgs.com/careers



Similar in set-up is the scale of Hodge and Sterner:

LD₅₀ for oral uptake by rats:

Up to 1 mg/kg	Extremely toxic
From 1 to 50 mg/kg	Highly toxic
From 50 to 500 mg/kg	Moderately toxic
From 500 to 5 000 mg/kg	Slightly toxic
From 5 000 to 15 000 mg/kg	Least toxic
From 15 000 mg/kg	(Relatively) harmless

In any case, compounds with an LD₅₀ for oral intake lower than 50 mg/kg are usually called extremely toxic for humans. Here are some figures for several well-known substances, for comparison:

vitamin C:	11 900 mg/kg
sodium chloride:	3 000 mg/kg
tetrahydrocannabinol:	1270 mg/kg
caffeine:	192 mg/kg
digitalin:	5–10 mg/kg
strychnin:	1 mg/kg
cyanide:	0,5–3,0 mg/kg
dioxin:	0,02 mg/kg (0,001 mg/kg for dogs)
botulism toxin:	1 ng/kg

Two other values which can be derived from the toxicity curve, are the *No Observed (Adverse) Effect Level (NOAEL/NOEL)* and the *Low Observed (Adverse) Effect Level (LOAEL/LOEL)*. The NOAEL is effectively the level of exposure of an organism, found by experiment or observation, at which there is no biologically or statistically significant increase in the frequency or severity of any adverse effects in the exposed population (such as an alteration of morphology, functional capacity, growth, development or life span).

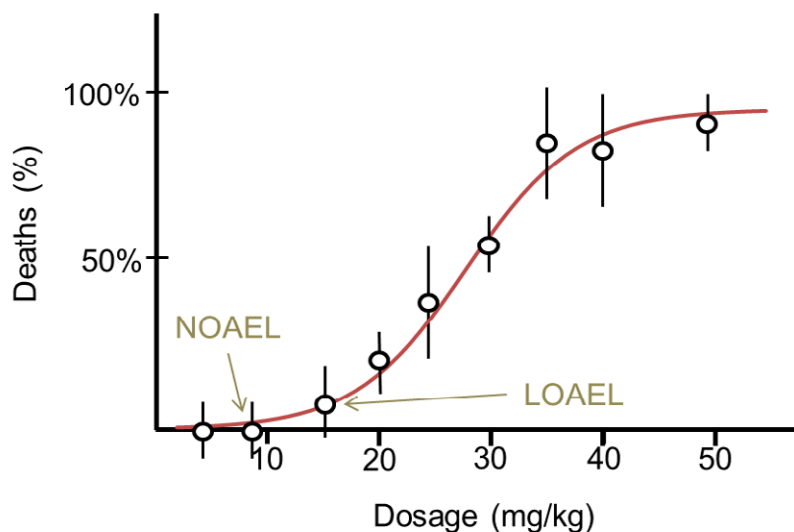

Figure 2-8. Definition for NOAEL and LOAEL on the basis of the toxicity curve

It is in turn used to calculate the so-called **reference dose** (RfD, an estimate of the daily oral exposure humans can undergo without an appreciable risk of adverse effects during a lifetime):

$$RfD \left(\frac{mg}{kg \cdot day} \right) = \frac{NOAEL \left(\frac{mg}{kg \cdot day} \right)}{UF_{inter} \cdot UF_{intra}}$$

To account for the fact that humans may be more or less sensitive than the test animal, a 10-fold uncertainty factor is usually applied to the NOEL. This uncertainty factor is called the “interspecies uncertainty factor” or UF_{inter} . An additional 10-fold uncertainty factor, the “intraspecies uncertainty factor” or UF_{intra} , is usually applied to account for the fact that some humans may be substantially more sensitive to the effects of substances than others.

A similar value to indicate maximal permissible human exposure is the **threshold limit value** (TLV) of a chemical substance, which serves as air quality standards and was developed by the American Conference of Governmental Industrial Hygienists. It is a level to which a person can be exposed day after day during his or her professional activities, for a working lifetime, without adverse health effects. They are usually expressed as a concentration of the possibly dangerous substance in the air, where they can be inhaled, or come in contact with exposed skin. Its units are in parts per million (ppm) for gases and in milligrams per cubic meter (mg/m^3) for particulates such as dust, smoke and mist. Both units can be interconverted using the following formula:

$$ppm = \frac{mg/m^3 \cdot 24.45}{molecular\ weight}$$

We distinguish three types of TLV's:

- Threshold limit value – Time weighted average (TLV-TWA): is the limit for the average exposure to a chemical on the basis of a 8h/day, 40h/week work schedule
- Threshold limit value – Short-term exposure limit (TLV-STEL): limits the duration of more acute exposure to periods of 15 minutes, that cannot be repeated more than 4 times per day, with a break of 60 minutes in between each exposure.
- Threshold limit value – Ceiling limit (TLV-C): gives absolute exposure limit that should not be exceeded at any time

Note that these values change over time, and – even more importantly – differ even between countries !

2.2.3 Alternatives for the LD₅₀ test

The LD₅₀-test was initially developed in 1927 for the biological standardisation of dangerous drugs. Later on, the test found its way as a useful method for routine toxicological testing of chemical compounds and became part of practically all governmental guidelines which regulate toxicological testing of chemicals. However, over the last decades, the test has undergone a lot of criticism (see for example. Zbinden and Flury-Roversi, 1981):

- The results are not reliable and depend too much upon different factors, such as animal species and strain, age and sex, diet, food deprivation prior to dosing, temperature, caging, season, experimental procedures, etc.... Hence, the LD₅₀ is not a biological constant. For example, one study demonstrated a LD₅₀ for thiourea of 4 mg/kg for one strain of rat and 1,830 mg/kg for another. That is a 458 fold difference, within the same species. Another study reported the oral LD₅₀ for 5-(N-piperidino)-10,11-dihydro-5H(a.d.)cycloheptene to be 1,160 mg/kg for the male mouse, but only 6.6mg/kg for the male rat (an organism belonging to a very closely related species). Extrapolation to the much more distant human species thereby becomes impossible.
- The test is not useful at all to study chronic effects of pollutants. Given the increasing volume of literature concerning the long term effect of several hitherto unsuspected chemicals, this is a major shortcoming: the test gives us a false sense of safety!
- The test does not allow to assess the effect of pollutants on special groups in the human population, such as new-born babies.
- It is one of the cruellest tests on animals known in modern science, especially when executed on such a large scale.

Other test methods, which are undoubtedly more benign towards animals, have taken the place of the LD50 method.

- The **fixed dose procedure**: here a fixed dose at one out of four levels (5, 50, 500 or 2000 mg/kg) is given once to five male and five female rats. The objective is to identify a dose that produces clear signs of toxicity but no mortality.
- The **acute toxic class method** (Schlede et al. 2005) is a sequential testing procedure using only three animals of one sex per step at any of the defined dose levels. Depending on the mortality rate three but never more than six animals are used per dose level. This approach results in the reduction of numbers of animals used in comparison to the LD50 test by 40–70%.
- In the **up-and-down procedure**, animals are dosed one at a time and followed for 7 days. If an animal survives, the dose for the next animal is increased; if it dies, the dose is decreased. A computer model is then used to calculate the LD50 from these data.
- Still mostly in the developmental phase are a number of **animal-free tests**. These use animal cell lines, yeasts or bacteria, and look for molecular responses to toxic substances.

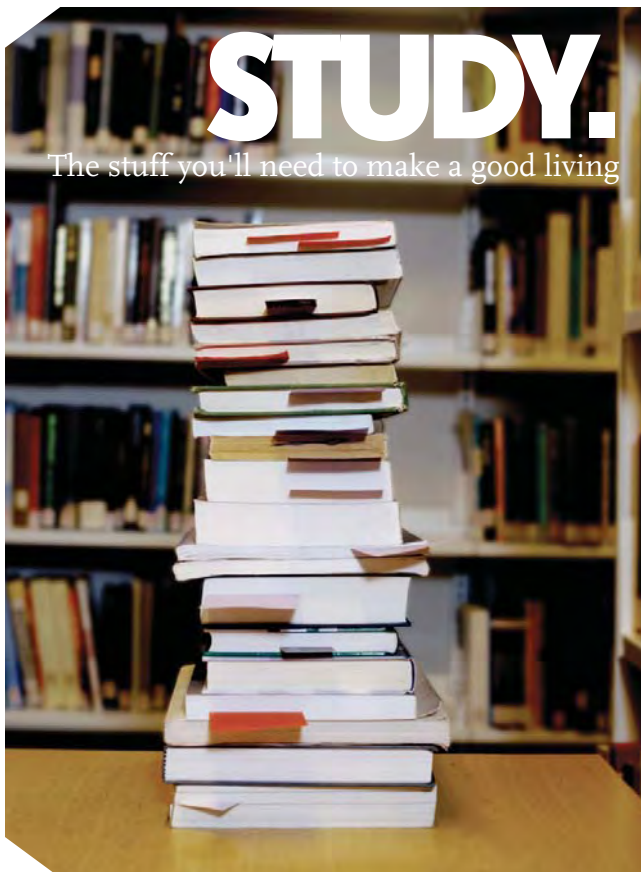

Click on the ad to read more

2.3 Using biological responses as a marker for pollution

Besides mortality, there are a number of different responses, on different organisation levels in the living world, that can be used to assess the impact of pollution. Such responses can help us to understand the mechanisms through which a pollutant affects a biological system, as well as warn us about the presence of the pollutant itself. As such, we can monitor the state of the response to know more about the level of pollution.

Such a response is called a biomarker. They can be found at different levels, from the molecular and cellular level up to the community and ecosystem level (again refer to Figure 2-5). Each of these markers has its own properties, advantages and disadvantages.

Biomarkers at molecular or cellular levels are supposed to respond rapidly to the presence of a pollutant. They have high toxicological relevance, and can serve as specific early-warning indicators of pollution. A frequent survey of such biomarkers in a threatened ecosystem may allow for a timely recognition of the pollution threat, before any irreversible damage can occur. On the other hand, it is equally possible to look at general effects on the population or ecosystem level. Here, the relevance is more ecological than toxicological; also, markers on these levels usually require less expensive lab equipment for biochemical and molecular determinations, and can be measured directly in the field. Of course, changes in physiological cell parameters may not be due to pollution levels (or pollution levels alone), but also because of other changes in the environment (seasonal changes, climatic changes, drought,...)

There are three kinds of biomarkers:

- **Exposure** markers are a measure for the amount of xenobiotic chemical that is present in the exposed organism, or the derivatives of this chemical due to biotransformation thereof.
- **Effect** markers are a measure for the direct consequences and responsiveness of an organism towards a certain pollutant.
- **Risk** markers are a measure for effects at the population, community and ecosystem level, For example, based on the induction levels of cytochrome P450 and the formation of DNA-adducts, one can calculate the probability of contaminant-caused cancers.

Sarkar et al. (2006) summarize the most significant features of the use of biomarkers as follows:

- Biomarkers show that a certain xenobiotic has indeed had an impact of an organism, also at sublethal effects, whereas a chemical analysis is only a measure for the contact between an organism and a contaminant, but not for the impact of the latter.
- They detect the presence of both known and unknown contaminants (whereas chemical analysis only detects those pollutants that are already under suspicion).

- Due to the fact that biomarkers work at a sublethal level, they can be turned into an early warning system.
- Chemical analyses provide often only a momentary insight, while a biological response lasts longer and is therefore able to provide a temporally and spatially integrated measure of the action of a pollutant.
- They allow for a mechanistic understanding of the deleterious consequences to the animal, of the routes of exposure and even possible venues for remediation.
- They allow for anticipation of changes on higher organisation levels.
- They may integrate the effect of various mixtures of pollutants (such as heavy metals and PCBs) (Siu et al. 2003, Domouthsidou et al. 2004).
- In principle, toxicity bioassays can provide information on the relative dangers posed by specific chemicals or effluents; however, extrapolation to the field situation is very difficult because of chemical speciation, absorption and uptake effects, bioaccumulation and actions not detected in short-term tests.
- Good biomarkers should be applicable to both laboratory and field studies.

In the paragraphs that follow, we will consider a number of possible, classical examples of biomarkers, starting at the lowest level (biochemistry and molecular biology), working our way of to the ecosystem level.

2.4 Molecular effects: single biomarkers

All pollution begins by interacting with the biomolecules in the cells of the affected organisms. We study this level mainly by using **biomarkers**: biochemical, physiological, morphological or histological events that are caused by the presence of a pollutant. In this section, we will deal with biomarkers on the molecular scale: increased or decreased protein activity and gene expression or the presence of specific enzymes or metabolites.

Looking for events on the molecular scale is a very useful approach, as they are bound to give a lot of mechanistic information on how the pollution has an impact on these organisms: which sites in a cell are targeted, which metabolic pathways are affected, which cellular processes are inhibited or blocked,... We can later on extrapolate this knowledge and predict the possible effect of related chemicals, or use it to understand what we see on larger scales. Secondly, we can use the biochemistry of an organism that has to deal with pollution as a sort of an early warning system. Biochemical changes are the first to happen after an organism comes into contact with a pollutant. Using biochemical biomarkers, we are able to assess the impact of a contaminant rather quickly, so that we may be able to deal with it in time to be able to reverse its effects. Lastly, we can use biochemical biomarkers to assess the impact of a mixture of different pollutants. By knowing which markers become active, we are able to deduce which of the components of the mixture have an actual impact and which not.

On the other hand, biochemical biomarkers are less valuable when assessing the ecological impact of a certain form of pollution, certainly in comparison with species richness or community composition. Possible biochemical markers comprise: detoxification markers, metal chelating proteins, stress proteins and DNA damage.

2.4.1 Detoxification markers

The first step in detoxification of a pollutant that has entered living cells, is its hydrolysis, reduction or oxidation. The main enzymes that are associated with these actions are the class of the **cytochrome P450 monooxygenases**. Depending on the isozyme, cytochromes P450 are able to perform a large range of chemical modifications on any xenobiotic molecule that has entered the cell: hydroxylation, epoxidation, deamination, oxidative and reductive dehalogenation, dealkylation,... A typical reaction is displayed below, with RH the (organic) xenobiotic molecule undergoing hydroxylation (see also Figure 29).

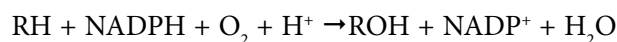

The consequence of this step is, that the xenobiotic molecule in general becomes less lipophilic, and, hence, more prone to be taken up into the watery elimination pathways of a cell. More general information on cytochrome P450 can be found in Goksøyr and Förlin (1992), Nelson et al. (1993), Goksøyr (1995), or Tabrez and Ahmad (2012)



**Technical training on
WHAT you need, WHEN you need it**

At IDC Technologies we can tailor our technical and engineering training workshops to suit your needs. We have extensive experience in training technical and engineering staff and have trained people in organisations such as General Motors, Shell, Siemens, BHP and Honeywell to name a few.

Our onsite training is cost effective, convenient and completely customisable to the technical and engineering areas you want covered. Our workshops are all comprehensive hands-on learning experiences with ample time given to practical sessions and demonstrations. We communicate well to ensure that workshop content and timing match the knowledge, skills, and abilities of the participants.

We run onsite training all year round and hold the workshops on your premises or a venue of your choice for your convenience.

For a no obligation proposal, contact us today at training@idc-online.com or visit our website for more information: www.idc-online.com/onsite/

OIL & GAS ENGINEERING

ELECTRONICS

AUTOMATION & PROCESS CONTROL

MECHANICAL ENGINEERING

INDUSTRIAL DATA COMMS

ELECTRICAL POWER

Phone: +61 8 9321 1702
Email: training@idc-online.com
Website: www.idc-online.com

IDC TECHNOLOGIES

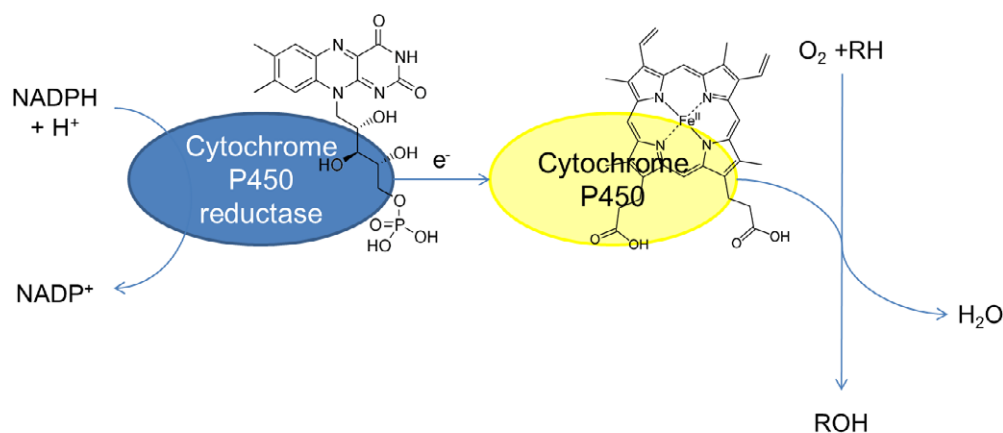

Figure 2-9. Reaction path of the cytochrome P450.

This group consists of several closely related isozymes (here represented in yellow) of about 45–60 kDa, carrying a haem b cofactor. They are usually linked to membranes (such as the membrane of the endoplasmic reticulum), where they are linked to a 78 kDa NADPH-dependent cytochrome P450 reductase (in blue), carrying a flavin mononucleotide cofactor. The NADPH supplies the electrons needed for the action of the cytochromes themselves. After Urlacher and Girhard (2012).

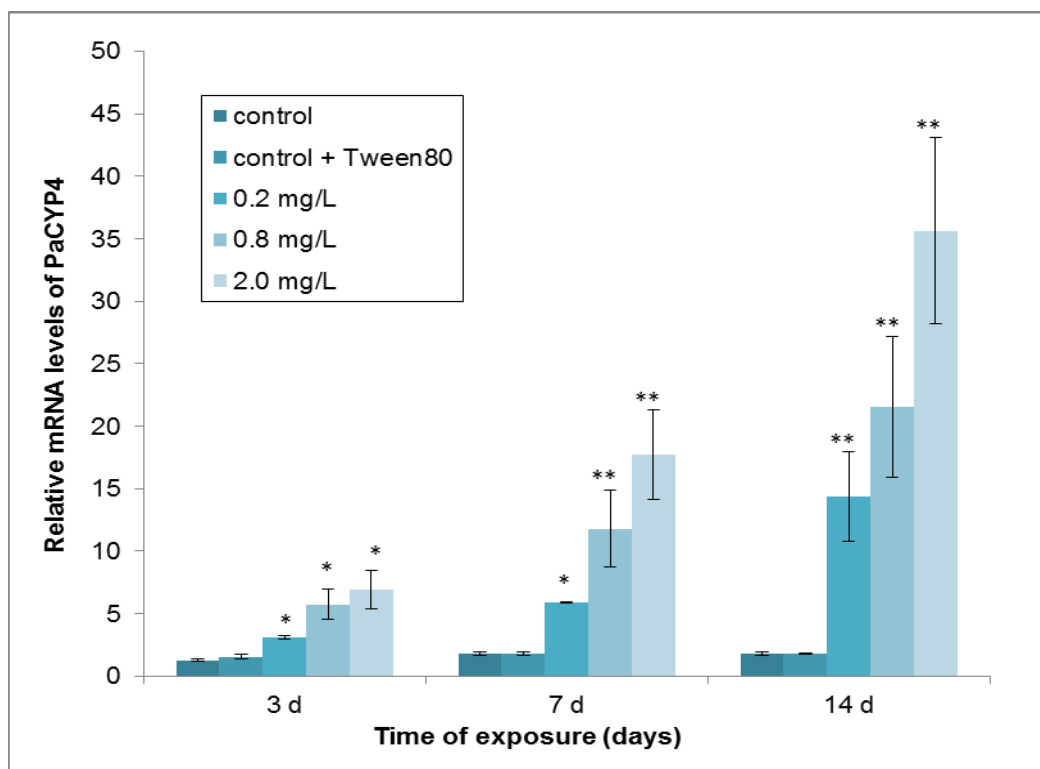

Figure 2-10. Cytochrome P450 is activated after hydrocarbon exposure.

Relative expression of the cytochrome P450 gene PaCYP4 in the polychaete *Perinereis aibuhitensis* under petroleum hydrocarbon exposure. Samples were treated with different concentration (0.2, 0.8, and 2.0 mg/L) for 14 days. * Indicates significant differences among concentrations within sampling times ($p < 0.05$), ** indicates extremely significant differences among concentrations within sampling times ($p < 0.01$). After Chen et al. (2012).

The second step is the formation of **conjugates** of the xenobiotic, through the addition of a carbohydrate, an amino acid, a glutathione or a sulfate to the pollutant. Again, this renders the pollutant more hydrophilic and therefore more easy to eliminate from the cell. Typical enzymes that are associated with this step are glutathione S-transferases, sulfotransferases (which respectively transfer a glutathione or a sulfate molecule to the toxicant) or uridinediphospho-glucuronosyltransferase (UDP-GT), an enzyme that catalyses the transfer of one molecule of glucuronic acid from UDP-glucuronic acid to an electrophilic compound (e.g. a polyaromatic hydrocarbon, see later).

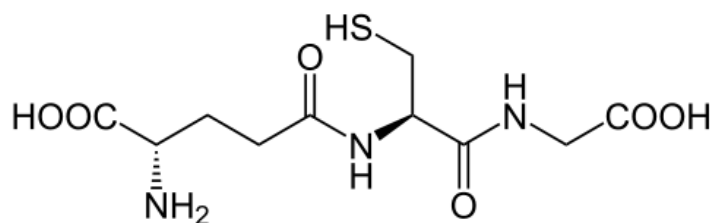

Figure 2-11. Glutathione: the tripeptide γ -glutamyl-cysteinyl-glycine

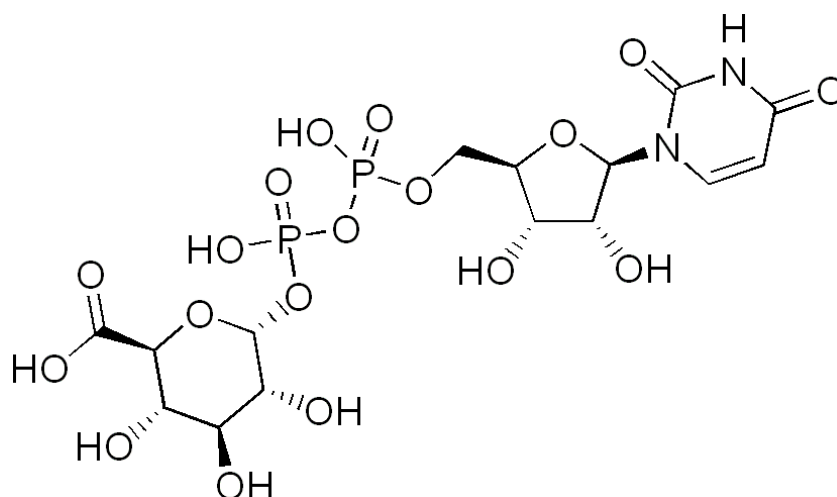

Figure 2-12. UDP-Glucose

2.4.2 Metallothioneins and phytochelatins

Metallothioneins are proteins of 6-7 kDa, consisting for about 25% of their amino acids of the thiol-bearing cysteine. They take part in the uptake, internal compartmentalisation, sequestration and possibly excretion of metal ions, both essential (e.g. Cu, Zn) and non-essential ones (e.g. Ag, Cd, Hg). Essential metals are those ions that play a specific role in our cellular metabolism. For example, Zn^{2+} ions are used in several transcription factor domains, the so-called zinc fingers, aiding these proteins to bind upon specific stretches of DNA. Non-essential metals are taken up into our cells, often due to a certain resemblance to any of the essential metals, but fulfil no specific role inside. For example, Cd^{2+} ions are mostly taken up by the Ca^{2+} ion channels, as both ions are roughly the same size and bear the same charge.

Elevated dosages of metals are able to elicit an enhanced production of metallothioneins (Figure 2-13). As such, they are an excellent biomarker for the occurrence of enhanced metal contents in the environment.

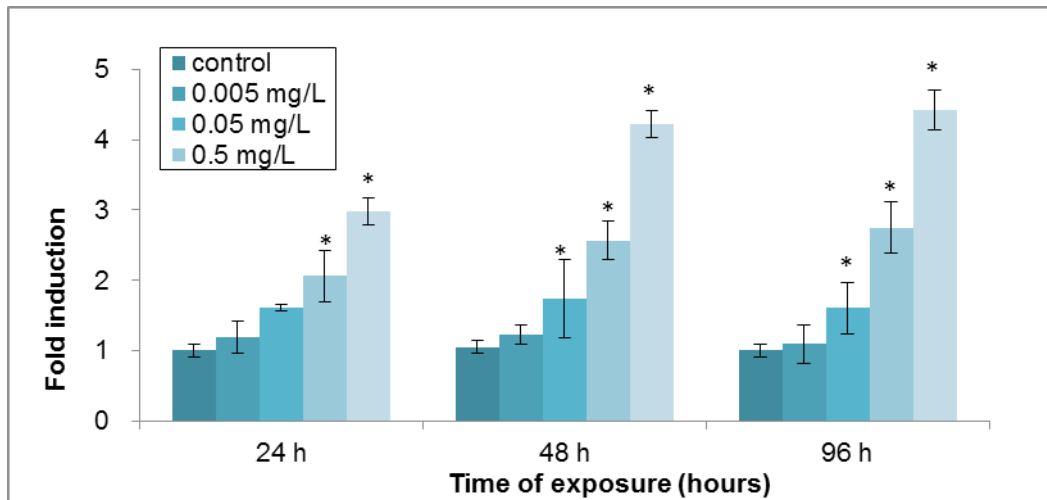

Figure 2-13. Expression of metallothioneins in gills of *Sinopotamon yangtsekiense* exposed to Cd. Crabs were exposed to 0.005, 0.05, 0.5, 5 mg/L Cd for 24, 48, 96 h. Metallothionein mRNA levels were evaluated by real-time quantitative PCR and expressed relative to β -actin levels. Each histogram represents the mean fold change relative to β -actin means \pm SD (n = 4). *Significantly different from each control (p < 0.05). Taken from Gao et al. (2012)

Plants synthesize an oligomer of glutathione, the so-called phytochelatin (Figure 2-14). These perform the same function as the metallothioneins in animals.

www.studyat.tudelft.nl

- Ranked #15th in the world (THES Technology ranking 2009)
- Almost 170 years of problem solving experience
- Excellent Sports&Culture facilities
- Check out what and how we teach at www.ocw.tudelft.nl !



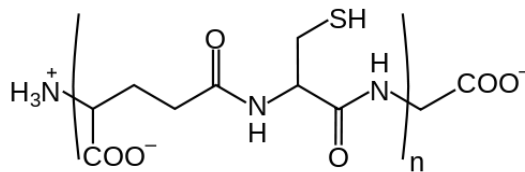

Figure 2-14. Phytochelatin (n lies between 2 and 10)

2.4.3 Stress defence enzymes and antioxidants

When an organism faces a certain stress (whether under the influence of heat, cold, xenobiotics, ultraviolet radiation, salt, anoxia, or any other condition threatening its regular development and survival), its cells erect a number of general defences, collectively known as the cellular stress response. Within this stress response, several functional groups of proteins can be distinguished.

The first group is the family of the **heat shock proteins**, named because the first time they were observed was in response to an elevated temperature. Later studies demonstrated that these proteins are involved in the response to many different forms of stress. Their apparent function is to ensure that proteins are folded properly: they associate with different proteins, direct the folding of these proteins, protect proteins from denaturation and undue aggregation, and they enhance refolding of damaged proteins. Finally, they assist in the transportation of the folded proteins to their intended location in the cell.

There are different heat shock proteins, distinguishable by way of their molecular weight: hsp90 (90 kDa), hsp 70 (70 kDa), hsp 60, low molecular weight heat shock proteins (16-24 kDa) and ubiquitin (7 kDa). Among these, hsp60, hsp70 and ubiquitin are the most suitable biomarkers. More information about heat shock proteins can be found in Feder and Hofmann (1999) and Tomanek (2011).

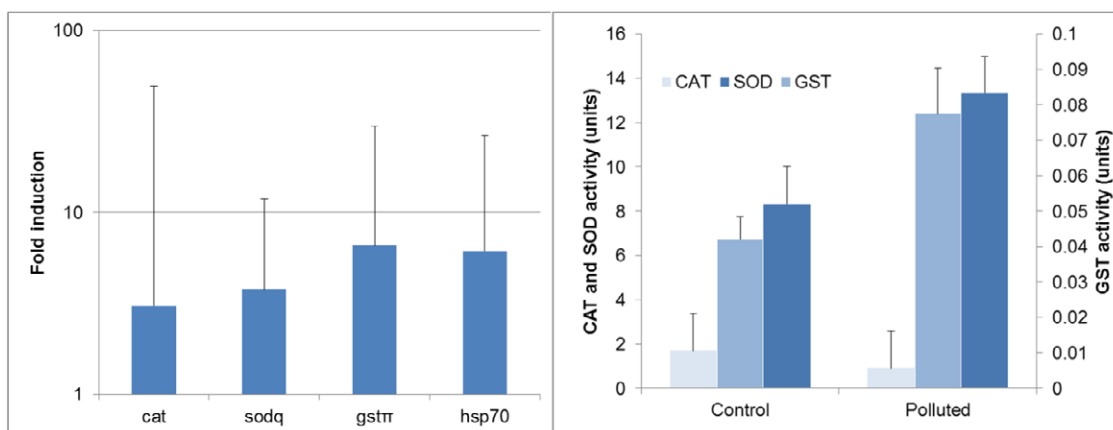

Figure 2-15. Effect of pollution on biomarkers in mussels collected in South Brazil.

Taken from Rola et al. (2012)

Left: *Molecular biomarkers in gills*: Relative gene expression (*cat*: catalase, *sod1*: superoxide dismutase, *gstr*: glutathione S-transferase and *hsp70*) observed in gills from mussels collected in the polluted site. Values are relative to the control group and expressed as mean ± SE (n = 6).

Right: *Biochemical biomarkers in mantle*: Catalase (CAT), superoxide dismutase (SOD) and glutathione S-transferase (GST) enzymatic activities in mantle of *Mytilus edulis*.

A second group consists of the proteins that are activated under **oxidative stress** conditions. Oxidative stress is a physiological condition where a cell has to deal with an increased production of so called reactive oxygen species (ROS). The term ROS refers to a collection of oxygen-derived molecules, such as singlet oxygen, the superoxide anion ($O_2^{\cdot-}$), hydrogen peroxide (H_2O_2), and the hydroxyl radical ($OH\cdot$). The transformation and relationships between different ROS species are given in Figure 216.

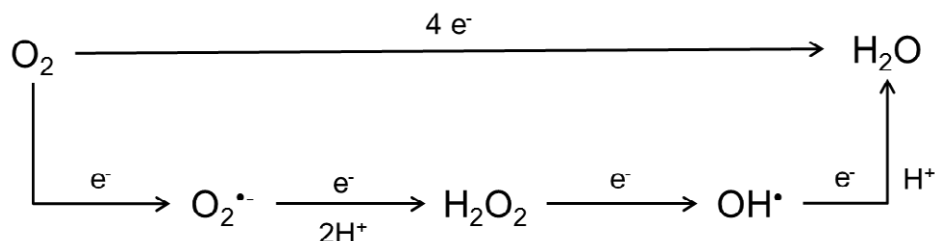
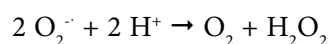

Figure 2-16. The different metabolic pathways from dioxygen to water.

In fact, ROS are the normal by-products of any aerobic metabolism. Normally, during respiration at the mitochondrial membrane, dioxygen is reduced to water in a reaction that takes 4 electrons (the upper arrow in the figure above). In a small percentage of the cases, the oxygen molecule is not reduced completely, but takes on one of the intermediate states. When it is reduced one electron at the time (as in the lower arrow in the figure), dioxygen is transformed sequentially into superoxide radical, then hydrogen peroxide, and then the very reactive hydroxyl radical. All of these entities are a lot more reactive than the dioxygen itself, and they are ready to attack any other molecule in the neighbourhood (proteins, lipids in membranes, DNA and RNA,...).

To avoid the damage caused by these ROS, cells are equipped with a number of enzymes that are meant to detoxify them:

Superoxide dismutase



Catalase

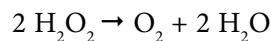

Peroxidase

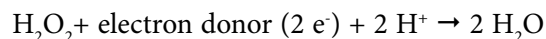
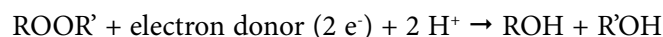

A more specific form is the ascorbate peroxidase, which uses ascorbate as an electron donor, or glutathione peroxidase, which uses glutathione instead.

In addition, the cell has a number of low molecular weight antioxidants at its disposal:

Ascorbic acid (best known as vitamin C), a hexuronic acid (Figure 2-17)

Glutathione, the tripeptide mentioned above (Figure 2-11)

Tocopherols (vitamin E), which are lipophilic and can be found in membranes. (Figure 2-17)

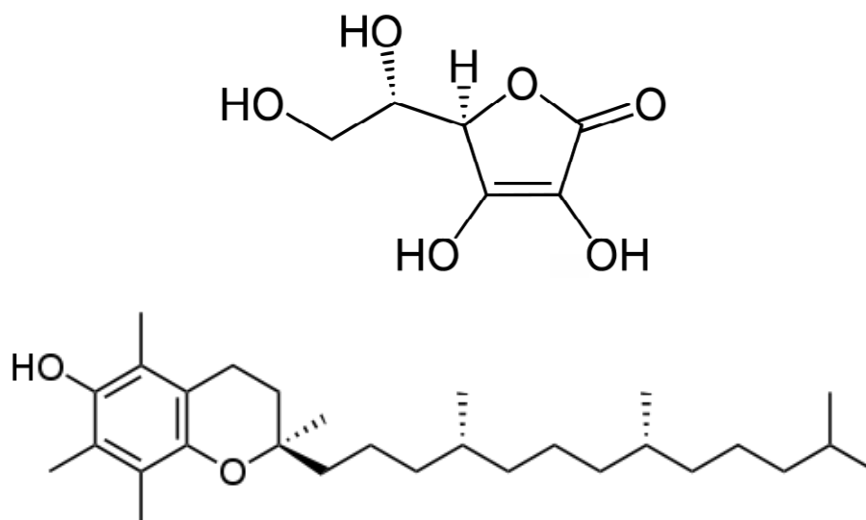

Figure 2-17. Molecular structures of ascorbic acid (top) and alpha-tocopherol (bottom)

When an organism is experiencing increased levels of stress, due to changing living conditions or increased levels of pollution, ROS levels are increasing too, and so must the cell's defences. The enzymes and antioxidants mentioned above are therefore excellent biomarkers for the occurrence of stress and pollution. An example has been shown in Figure 2-15.

Increased levels of ROS are also able to cause membrane dysfunction, due to the formation of lipid peroxides. The product that is formed during this process is malondialdehyde (Figure 2-18). Its occurrence can also be used as a biomarker for oxidative stress.

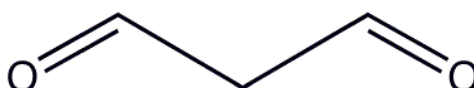

Figure 218. Malondialdehyde

2.4.4 DNA modifications

Lastly, there are a number of pollutants that are able to interfere with the structure of the DNA of an exposed cell. They are called **genotoxic** compounds.

- Reactive oxygen species can oxidise the bases of the DNA, or break one (or both) backbone(s).
- Xenobiotic products (such as polyaromatic hydrocarbons and polyhalogenated biphenyls) can bind to the bases (or, less frequently) elsewhere on the molecule and form a so-called adduct.
- Metals can bind to the phosphate groups in the backbone or to the bases and render them instable and unable to function normally. Copper will for example compete at the site of the hydrogen bonds linking both bases in a base pair, and in doing so, destabilise the DNA in that spot. Mercury will form strong crosslinks between both strands.

These reactions take also place under normal, optimal conditions. However, in times of stress and pollution, the attacks on the DNA may be so intense and frequent, that the normal repair mechanisms become overwhelmed.

All this may result in high mutation rates and carcinogenic and teratogenic effects. In addition, chromosomes may break, leading to structural anomalies and aneuploid cells.



"I studied English for 16 years but...
...I finally learned to speak it in just six lessons"
Jane, Chinese architect

ENGLISH OUT THERE

Click to hear me talking before and after my unique course download

2.5 Modern technology: ecotoxicogenomics

With the advent of the modern day systems biology and its high-throughput techniques, a lot of new possibilities have opened up to investigate the impact of pollutants on different aspects of cell physiology. Instead of using only a handful of very specific markers, it is now possible to investigate what happens with every individual gene, protein or metabolite, using respectively array-based technologies for the study of the transcriptome, 2D-gel electrophoresis to study the proteome and HPLC, GC or UPLC-driven analyses of the metabolome.

More specific investigations of the latter study the lipidome (all the lipids in a cell or tissue), the glycome (the entire complement of sugars, whether free or present in more complex molecules, of a cell or tissue), the kinome (all the kinases in the proteome of a cell or tissue), the regulome (all transcription factors in a specific cell), etc....

Bringing all these tools together in search of more information on the action of pollutants on an ecological scale has led to the branch of ecotoxicogenomics.

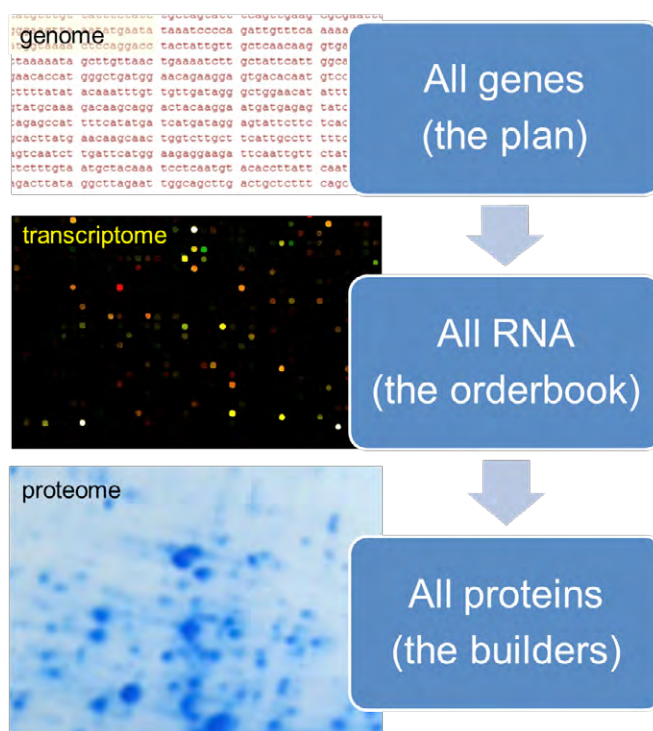

Figure 2-19. The different branches of ecotoxicogenomics

2.5.1 Transcriptomics: investigating gene expression at the RNA level

The first functional level to investigate is the RNA level: here we investigate which changes occur in terms of gene expression following exposure of a cell to a certain level of a pollutant. The best tool to do so, is the microarray.

To illustrate its working principle, we will discuss here one type of array: the cDNA oligonucleotide microarray. The other important type is the Affymetrix gene chip. At the end of the explanation, the reader will find a couple of informative links to videos on YouTube, which can be used to illustrate the general principle or expand the information given here.

In both cases, the chip (the array) is the basis of the whole methodology. In the case of a cDNA oligonucleotide microarray, this is nothing else but a microscope slide, of which the surface has been treated to accommodate an easy binding of a DNA molecule. On this surface, minute spots have been placed, consisting of a solution of a single-strand DNA probe of 60 bases long, specifically representing one gene of the organism we wish to study. Every spot (with a diameter of not more than 100 μm) contains only one type of probe. On the whole array, tens of thousands of spots are available, covering a large part of the coding sequences in the genome of the organism (if not all of them).

In a typical experiment, the gene expression of two different cells (tissues, organisms) is being compared: one is a control cell, the other has been treated in a certain way (concentration, duration of exposure,...) with a pollutant. From either cell, the mRNA is isolated and amplified under controlled conditions. One population of mRNA is labelled with the fluorescent dye cyanine-3 (Cy3), the other with the sister component cyanine-5 (Cy5).

Study at one of Europe's leading universities



DTU, Technical University of Denmark, is ranked as one of the best technical universities in Europe, and offers internationally recognised Master of Science degrees in 39 English-taught programmes.

DTU offers a unique environment where students have hands-on access to cutting edge facilities and work

closely under the expert supervision of top international researchers.

DTU's central campus is located just north of Copenhagen and life at the University is engaging and vibrant. At DTU, we ensure that your goals and ambitions are met. Tuition is free for EU/EEA citizens.

Visit us at www.dtu.dk



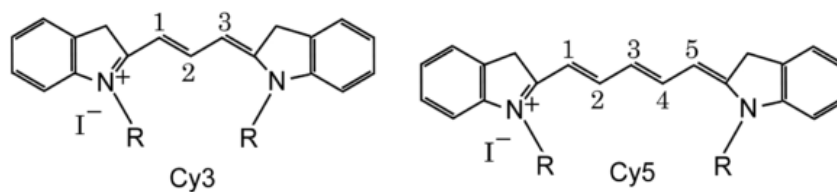

Figure 2-20. Molecular structures of dyes cyanine-3 and cyanine -5.

Both populations of mRNA are then mixed and hybridised on the array. During hybridisation, the labelled molecules will bind with the corresponding (complementary) probe. The higher the gene expression in one of both cells, the more of its gene product (mRNA) is present in the mix, and the more will bind to the array. After hybridisation, the array is scanned with a laser and the intensity of every fluorescent colour at every spot of the array is measured. To enhance the visual image, a false colour will be implemented on the image of the array, where the fluorescence of either compound will be represented by green (for Cy3) or red (for Cy5).

This leads to three qualitative possibilities:

- If there is no or hardly any gene activity in either of both cells, the spot will be black.
- If the gene is expressed much more under one condition, then the spot will look green or red.
- If the gene is highly expressed under both conditions, the spot will appear yellow after scanning and false colouring.

Of course, the measurement of the laser scanner does not lead to only three options. It is a quantitative measurement, and the exact fluorescence level of both Cy3 and Cy5 are stored for every individual pixel on the image. As such, gene expression can be quantified and comparisons can be made within each chip.

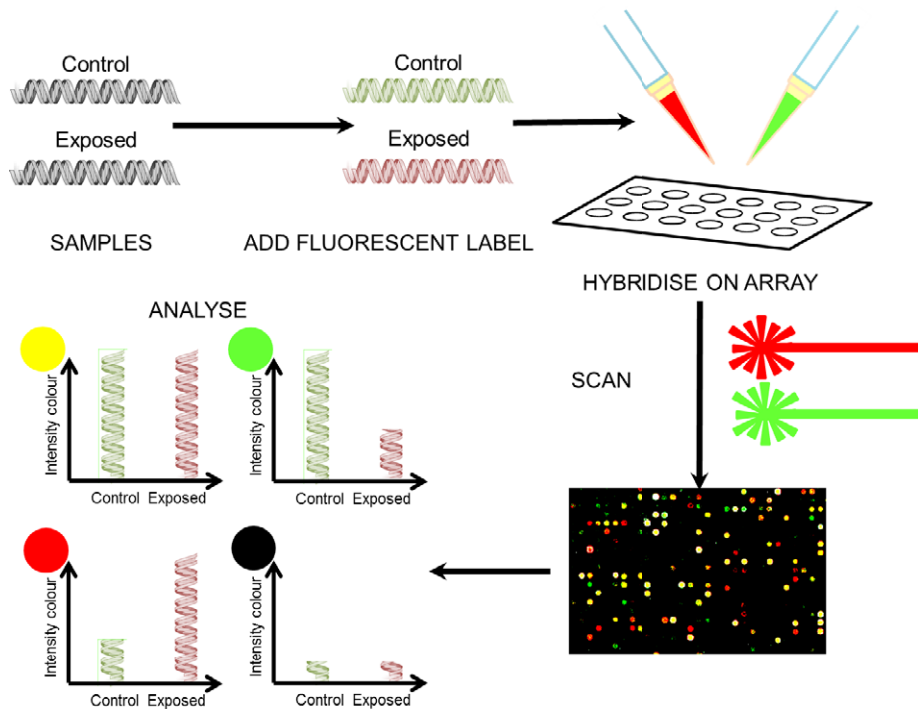

Figure 2-21. Schematic representation of a microarray experiment
 More information can be found at:
 Affymetrix Microarrays <http://www.youtube.com/watch?v=MuN54ecfHPw>.
 DNA microarray <http://www.youtube.com/watch?v=VNstHmNjKhM>
 DNA Test Methods – DNA Microarrays http://www.youtube.com/watch?v=3jX_08zdYCE.



MSM

MAASTRICHT SCHOOL OF MANAGEMENT

Increase your impact with MSM Executive Education





For almost 60 years Maastricht School of Management has been enhancing the management capacity of professionals and organizations around the world through state-of-the-art management education.

Our broad range of Open Enrollment Executive Programs offers you a unique interactive, stimulating and multicultural learning experience.

Be prepared for tomorrow’s management challenges and apply today.

For more information, visit www.msm.nl or contact us at +31 43 38 70 808 or via admissions@msm.nl

the globally networked management school



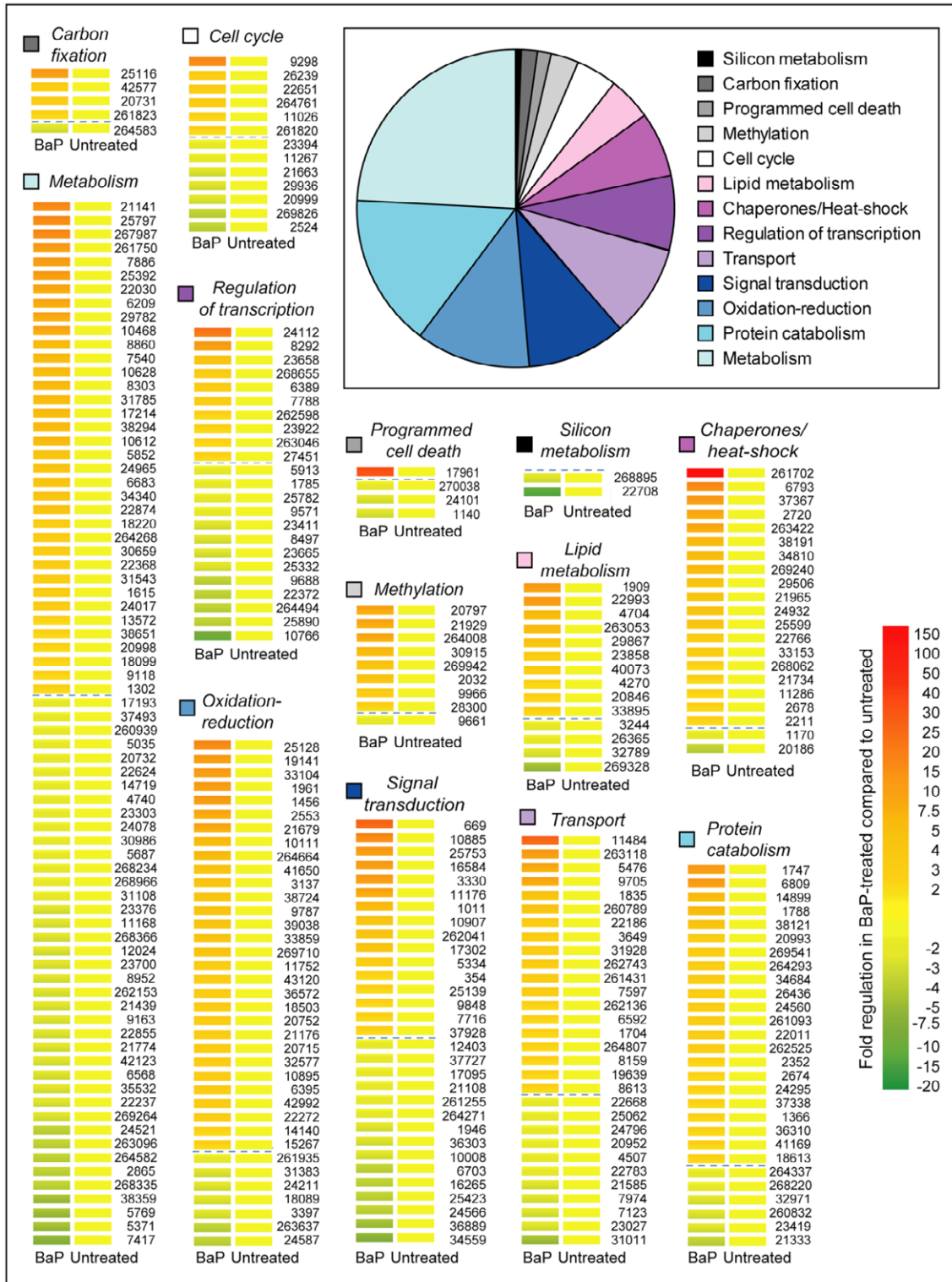

Figure 2-22. Example of a transcriptome study on a marine diatom (*Thalassiosira pseudonana*) exposed to benzo[a]pyrene. Taken from Carvalho et al. 2011

2.5.2 Proteomics: investigating proteins and posttranslational modifications

Investigating the proteome (the set of all proteins occurring in a cell) is even more complex than investigating the transcriptome. For starters, a cell contains many more types of proteins than mRNA sequences. The main reason is that 40–60% of the mRNAs can be spliced in different ways, before being translated to a protein sequence, leading to two or more splice variants of that gene, each encoding a different protein molecule.

On top of that, there are many of these proteins which need to undergo posttranslational modifications in order to become active. These modifications need also to be taken into account when one wants to give a full account of the state of the proteome. For instance, some proteins or protein complexes need to be phosphorylated, once or more, in order to be activated (or deactivated). The phosphate group will then be bound covalently to a serine, threonine or tyrosine residue in the protein chain. One of these complexes is the cyclin dependent kinase complex. Other examples are the p53 protein in the apoptosis signalling pathway or the MAP kinase pathway in the signalling transduction. Other chemical groups which modify the activity of certain proteins are carbohydrates, acetyl, nitrosyl or ribosyl groups.

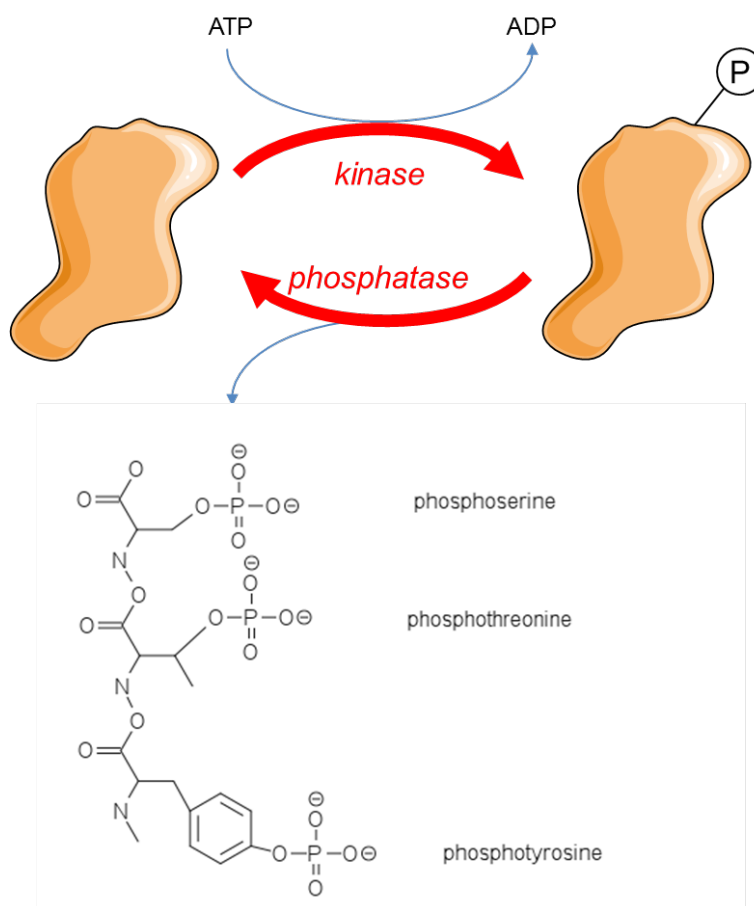

Figure 2-23. Examples of protein phosphorylation

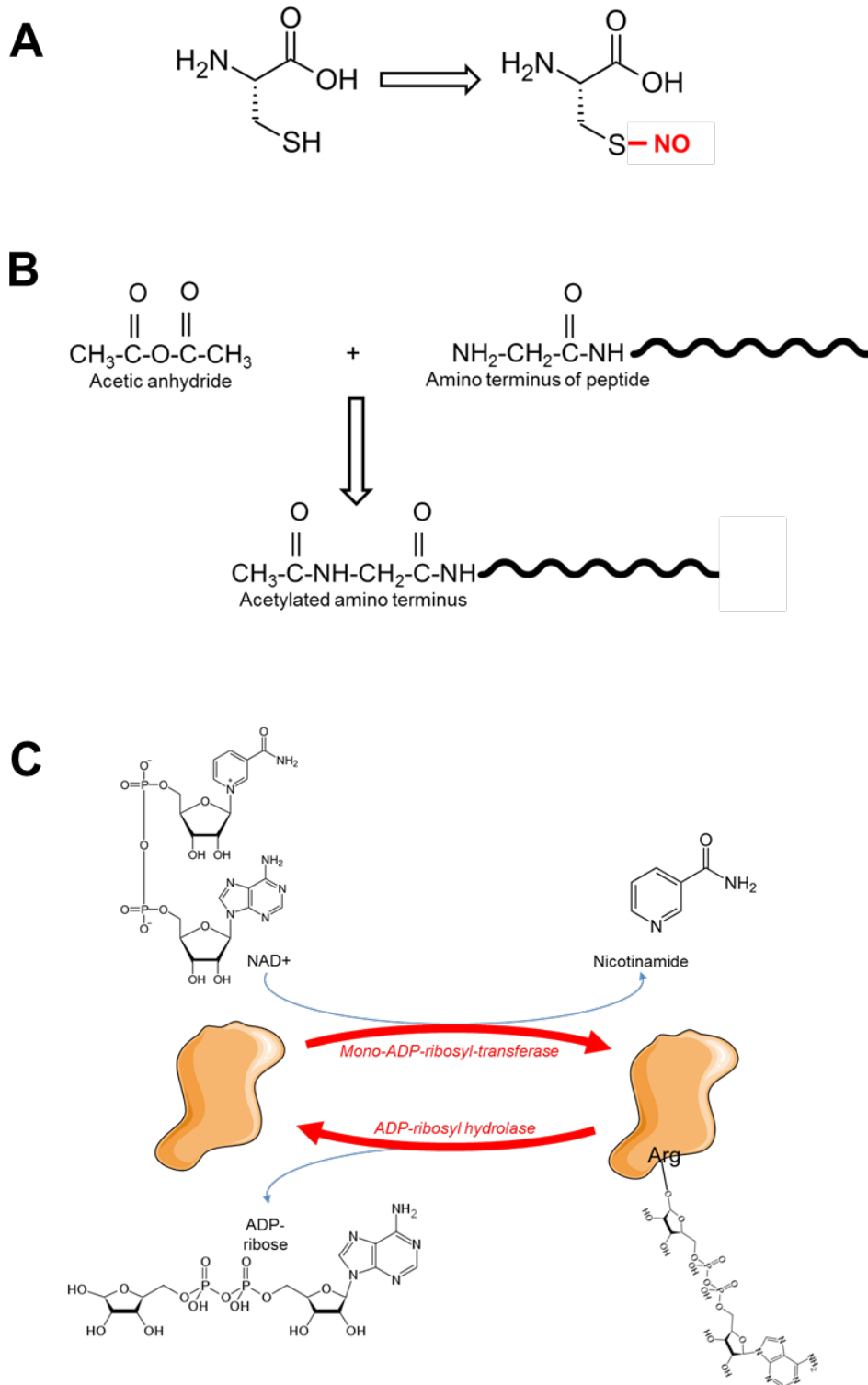

Figure 2-24. Alternative protein modifiers

(A) nitrosylation of a cysteine residue,

(B) acetylation of an N-terminal lysine residue and (C) ADP-ribosylation of an arginine.

Studying the proteome may be more complex than limiting yourself to the transcriptome, but the amount of extra information it delivers is worth the effort. In addition, most proteins are more stable than mRNA which makes handling the samples easier. On the other hand, it will require a lot more specialised equipment than just for handling microarray analysis. Proteomics is therefore a technology that is (at the moment) only available in specialised labs.

The basis of a proteome analysis is two-dimensional gel electrophoresis (Figure 2-25), linked to identification of the individual proteins by way of mass spectrometry.

gaiTEYE
Challenge the way we run

**EXPERIENCE THE POWER OF
FULL ENGAGEMENT...**

.....

**RUN FASTER.
RUN LONGER..
RUN EASIER...**

**READ MORE & PRE-ORDER TODAY
WWW.GAITEYE.COM**

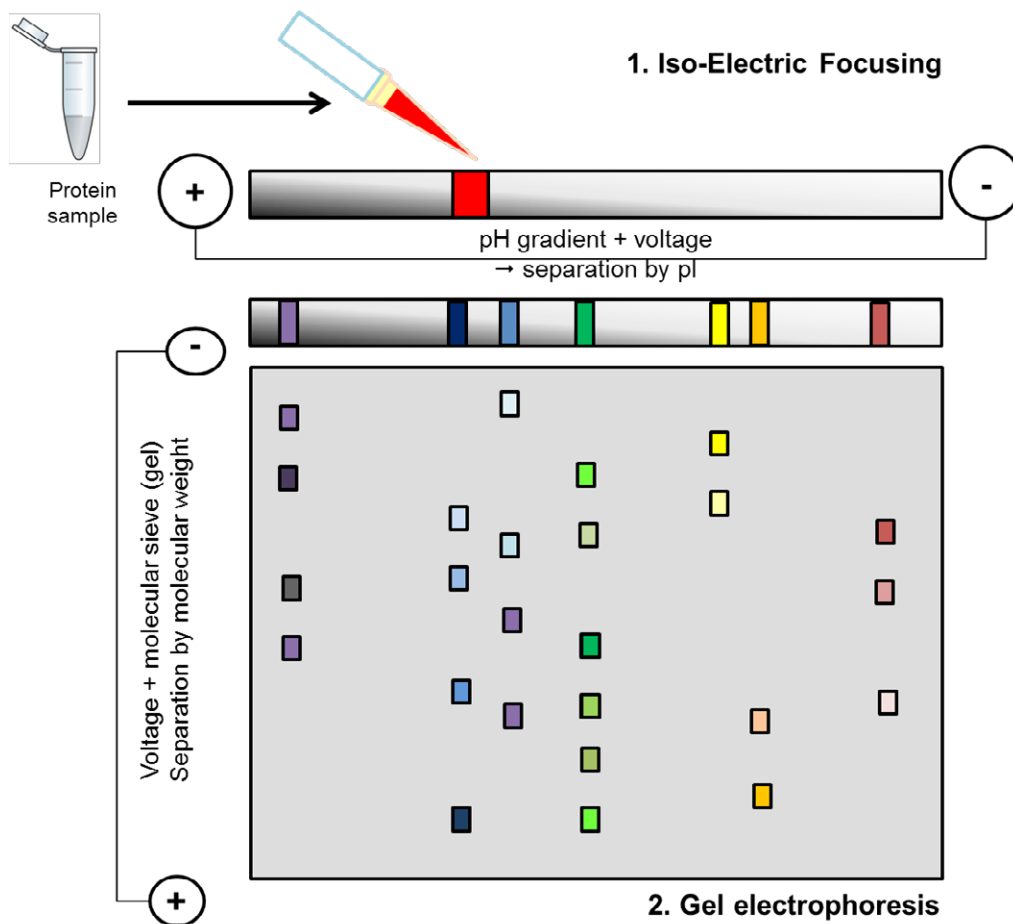

Figure 2-25. 2D gel electrophoresis

The first step consists of **iso-electric focusing** of the proteins. This separates the proteins on the basis of their pI (the pH value at which the total sum of positive and negative charges on the amino acid moieties is zero). This happens by applying the mix of proteins on a strip with a pH gradient and subjecting this strip to an electric field. A positively charged protein will be attracted to the negative pole and a negatively charged protein to the positive pole. However, this charge depends upon the pH of the surroundings of the protein. While the protein migrates, this pH will change, and so will the charges on its amino acids. The protein comes finally to a full stop at that spot where the pH is equal to its pI. Subsequently, the strip is placed on top of a polyacrylamide gel and the whole setup is now subjected to a vertical **electrophoresis** step. This separates the proteins on the basis of their molecular mass.

When performing a proteome analysis, researchers often wish to compare the proteome of different cells, tissues,... To this end, the proteins will be coloured with different fluorescent dyes. Similarly as in microarray analysis, a mix of both samples (with in each the proteins linked to a specific dye) is subjected to 2D gel electrophoresis (Figure 2-26, left). Afterwards, differences in fluorescence will be noted – both in quantity (indicating a difference in the amount of one specific protein between both samples) or in spot location (indicating changes in mass and/or pI due to any kind of modifications made to the protein, as mentioned above).

The next phase calls for an identification of these spots. The proteins in these locations will be isolated from the gel (one by one) and cut into pieces with proteases, which will then be subjected to mass spectrometry. During the measurement, the pieces will be fragmented even more, leading to a mass spectrum – an overview of the different fragments, with the correct mass given for each fragment. This is also called a peptide fingerprint. Comparison of this fingerprint with a database helps to identify the protein that is linked to the aberrant spot (Figure 2-26, right).

An example of such a study is given in Figure 2-27.

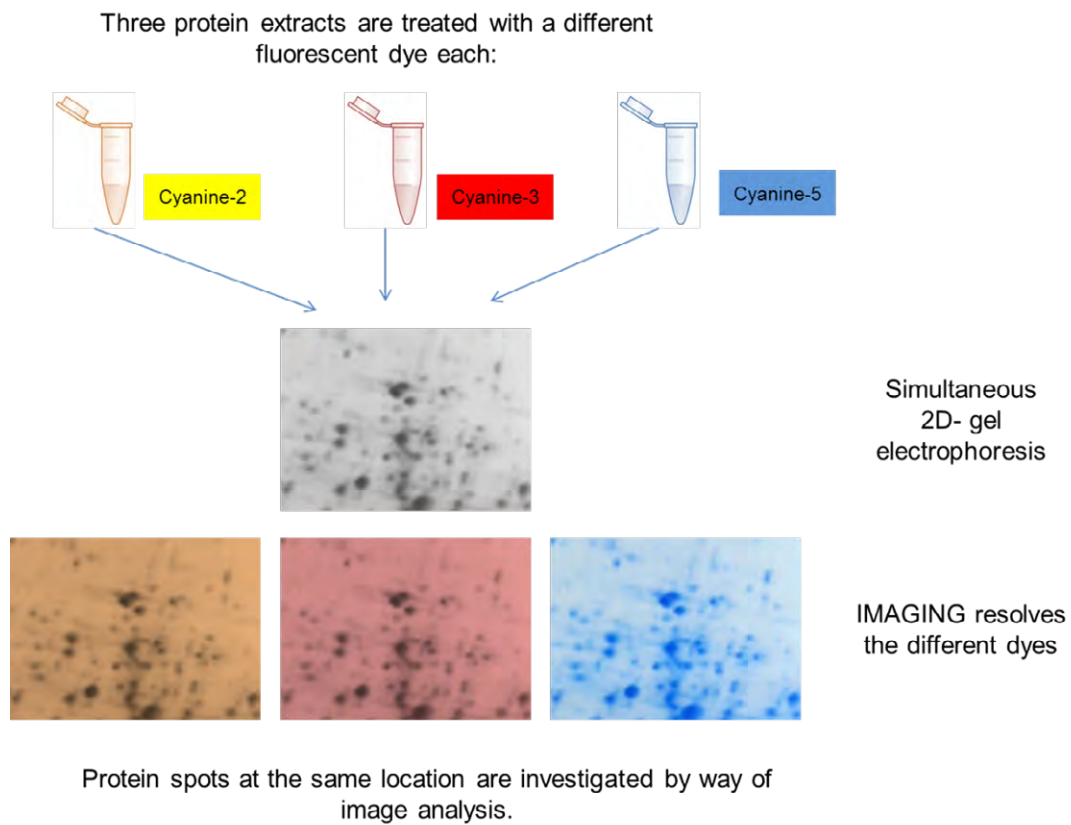

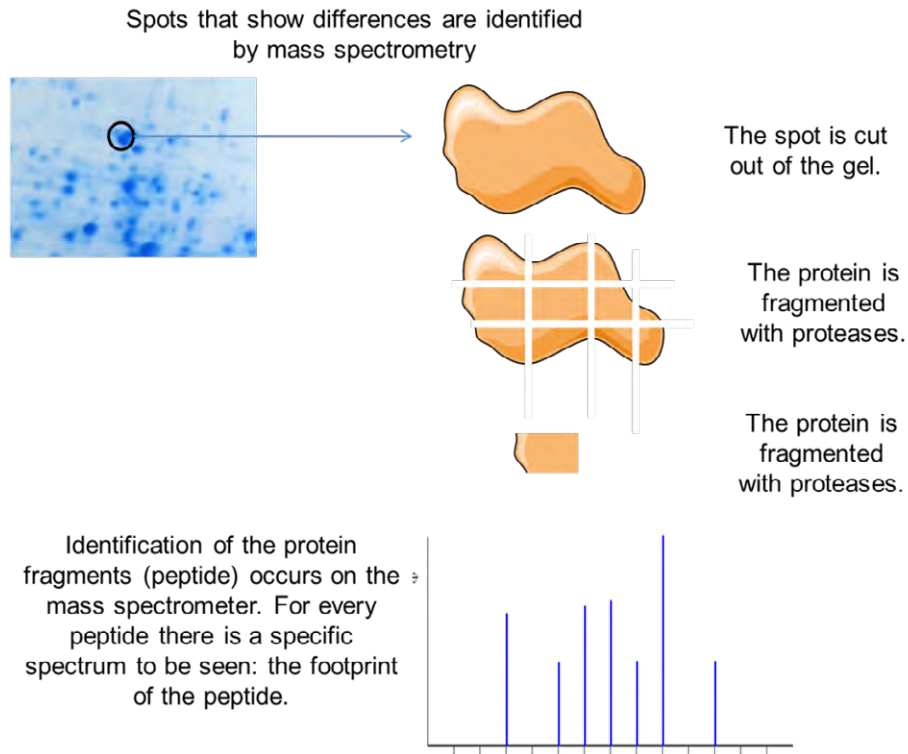

Figure 2-26. Proteome study methods

DESTINATIONS

	GATE	ARRIVAL
INDUSTRY IMPACT	OW	FASTER
GLOBAL ASSIGNMENTS	OW	FASTER
SENIOR CLIENT CONTACT	OW	FASTER
CAREER DEVELOPMENT	OW	FASTER
MAKE PARTNER	OW	FASTER

OLIVER WYMAN



Oliver Wyman is a leading global management consulting firm that combines deep industry knowledge with specialized expertise in strategy, operations, risk management, organizational transformation, and leadership development. With offices in 50+ cities across 25 countries, Oliver Wyman works with the CEOs and executive teams of Global 1000 companies.
An equal opportunity employer.

GET THERE FASTER

Some people know precisely where they want to go. Others seek the adventure of discovering uncharted territory. Whatever you want your professional journey to be, you'll find what you're looking for at Oliver Wyman.

Discover the world of Oliver Wyman at oliverwyman.com/careers



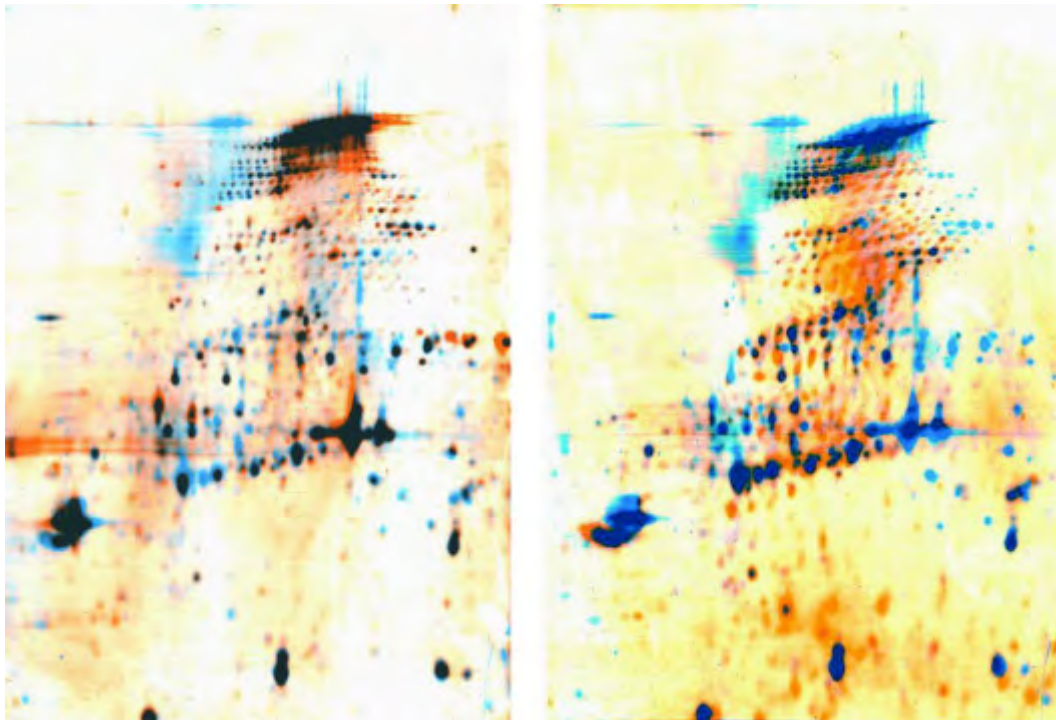

Figure 2-27. Ecotoxicological proteome analysis.

Comparison of protein changes induced by produced water treatment and 17β -oestradiol exposure of cod (*Gadus morhua*). Left: protein changes induced by 1.0% PW (orange) compared to control (blue) detected by 2DE and image analysis in whole fry individuals. Right: protein changes induced by $10\ \mu\text{g/l}\ E_2$ (orange) compared to control (blue) detected by 2DE and image analysis in whole fry individuals. Taken from Bohne-Kjersem et al. 2010.

SEE MORE? Genomics and proteomics, http://www.youtube.com/watch?v=KGZHISs_cel

Introduction to 2D Gel Electrophoresis, <http://www.youtube.com/watch?v=V3ArPwoRK5k>.

2D Gel Electrophoresis Applications, <http://www.youtube.com/watch?v=nVpZkfc0ezk>.

Mass Spectrometry MS, http://www.youtube.com/watch?v=J-wao000_qM

2.6 Modifications to tissues and organs

Moving up from the cellular and subcellular level to the level of tissues and organs, we expand our toolbox to investigate the effect of pollutants on the organisms living in the affected zone. Here, we distinguish between a number of histopathological parameters, chromosomal damage (already discussed above in 2.4.4) and the formation of neoplastic tumours (cancer).

2.6.1 Histopathology

Histopathological biomarkers deal with changes in the normal structure and functioning of a tissue, and the onset of pathological conditions. Such conditions may indeed be the result of all too often exposure to certain pollutants (survey: Table 2-6).

The first one are **necrotic lesions**. These are cell deaths, characterised by a strongly stainable chromatin mass in the nucleus (pycnosis), which becomes basophilic and may even start to disintegrate (karyolysis). The mitochondria swell and cytoplasmic granules tend to increase in number. Necrotic cells will eventually become dislocated from their original place in the tissue and slough off.

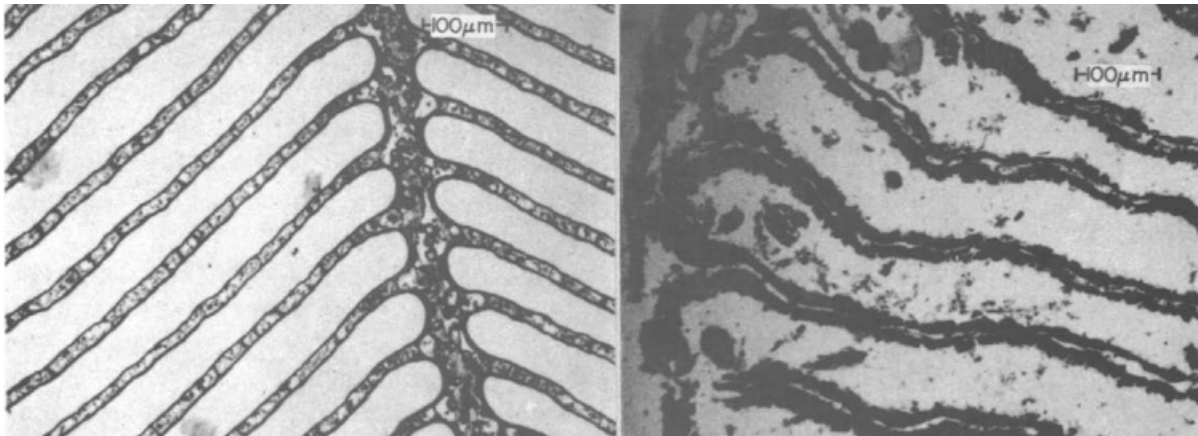

Figure 2-28 Healthy (left) and necrotic gill tissue in the crab *Cancer irroratus* exposed to sewage sludge. Taken from Young and Pearce (1975).

In many cases, such necrotic lesions are accompanied by **inflammatory** processes. These occur in response to cell injury and will attempt to isolate and destroy the offending agent or at least the damaged cells. In humans, the five cardinal signs of inflammation are pain (dolor), redness (rubor), immobility (loss of function – function laesa), swelling (tumor) and heat (calor). The redness and heat are due to an increased blood flow to the inflamed site, where its accumulation causes the swelling. The pain is due to a release of chemicals which stimulate nerve endings. Of course, in cold-blooded species, heat production does not occur, and the redness is only applicable in species with red blood. With the blood, some leucocytes arrive at the scene as well, which will migrate from the blood into the damaged tissue. Their presence is therefore an excellent marker for inflammation. Later in the process, small blood vessels and connective tissue will start to form in the affected spot, forming a mass of granulation tissue (granulocytoma, see Figure 2-29). Also, some scar tissue may form.

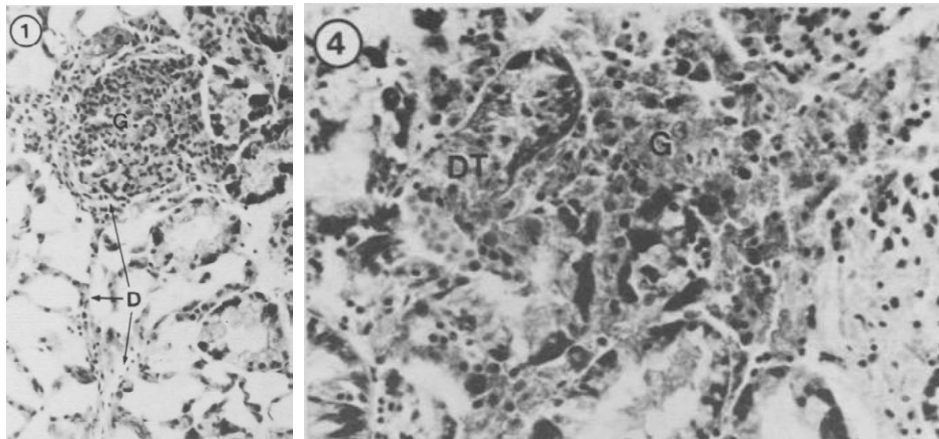

Figure 2-29. Inflammatory responses in mussels living in polluted water.

Left: section of the digestive gland of *Mytilus edulis* showing a small granulocytoma (G) within a dilated haemolymph duct (D). Right: granulocytomas invade the glands between the digestive tubes, while the latter to break down. Taken from Lowe and Moore (1979).

Histopathological biomarkers are easily and cheaply determined. However, their interpretation requires a thorough knowledge of the normal histology of the species we wish to examine. In a lot of cases, such information is only abundantly present for a number of model organisms. Secondly, histopathology is largely seen as a qualitative branch of science, a problem which may be overcome with suitable attention to quantification by the investigator.

Day one
and you're ready

Day one. It's the moment you've been waiting for. When you prove your worth, meet new challenges, and go looking for the next one. It's when your dreams take shape. And your expectations can be exceeded. From the day you join us, we're committed to helping you achieve your potential. So, whether your career lies in assurance, tax, transaction, advisory or core business services, shouldn't your day one be at Ernst & Young?

What's next for your future?
ey.com/careers

ERNST & YOUNG
Quality In Everything We Do

© 2010 EYGM Limited. All Rights Reserved.

Compound	INFLAMMATORY REACTIONS			OTHER ACUTE CHANGES		
	Dilated blood spaces	Postlateral cavities	Migration of granular haemocytes	Frontal cell erosion	Lateral cell erosion	Loss of internal cilia
K ₂ SO ₄	x	x	x			
CdCl ₂	x	x	x			
CdSO ₄	x	x	x			
CuCl ₂	x	x	x			
CuSO ₄	x	x	x			
PbO ₂	x	x	x	x	x	x
AgNO ₃	x	x	x	x		
PCBs				x	x	x
DDT				x	x	x

Table 2-5. Acute histological changes in the gills of *Mytilus edulis* after exposure to different pollutants. Data taken from Sunila (1988)

Histocytological biomarkers	Indicative of
Fin erosion	General health condition of fish (and indirectly general stress and toxicants in water)
Skeletal malformation	General health condition of fish and chlorinated hydrocarbons
Epidermal hyperplasia	General health condition of fish, related to toxicants and general environmental stresses
Operculum abnormalities	General health condition of fish and pulp mill effluents
Liver histopathology	General health condition of fish and levels of toxic xenobiotics, carcinogens and urban pollution
Gill histopathology	General stress to metals, oil, pulp mill effluents, organic pollutants, toxic algae and suspended solids
Kidney histopathology	General health condition of fish and toxic organic contaminants
Macrophage aggregates	General chemical and physical stresses
Embryonic defect	Organic contaminants
Histopathology of bivalves	Organic contaminants, pesticides, oil
Lysosome integrity	General stress in living cells, respond to a wide range of contaminants
Lipopigment content	Oxidative stress caused by PAHs and oil
Peroxisome proliferation	Oxidative stress caused by PAHs and oil

Table 2-6. A summary of the reviewed histocytological biomarkers and their indicative types of pollution/stress. Taken from Au (2004).

2.6.2 Cancer

Cancer is a disease, caused by a change in the genetic make-up of a somatic cell, where this cell and its daughter cells start to divide and grow uncontrollably, forming malignant tumours which invade nearby parts of the body (a neoplasia), or spread to more distant parts of the body through the lymphatic system or bloodstream (metastasis).

While the causes of cancer may be widespread, there is one common consequence: a heritable change in the genome of the affected cells. This can occur due to random mutations, whether simply by chance or catalysed by the presence of a chemical or physical influence on the DNA molecule directly, or because of the infection of the cell with an oncovirus, inserting its viral genome in the chromosomes of the host cell. In all these cases, the so-called proto-oncogenes (genes that are able to control the normal growth and development of a cell) become dysfunctional and change into oncogenes. Once enough proto-oncogenes have been changed, the affected cells will start to divide and develop into a tumor. Given that several pollutants are able to interfere with DNA, the occurrence of tumours can serve well as a biomarker for pollution.

2.7 Biomarkers on the organismal level

2.7.1 Selyean stress

The exposure to sublethal levels of pollutants often causes a number of non-specific symptoms in an organism, which lead, altogether, to suboptimal performance in terms of growth and development. The term usually linked to these conditions, is **stress**.

All in all, stress is an often misused container term with no specific meaning. The first to properly explain the concept and try to give it a biochemical background, is the Hungarian endocrinologist Hans Selye (Figure 2-30, left). He noticed that an organism, when faced with an extraordinary demand (workload, adverse conditions to deal with, xenobiotics to detoxify,...) exhibits a non-specific reaction pattern. He reasoned that any set of conditions that threaten an organism's well-being (a stress) leads to a three-stage bodily response (Figure 2-30, right):

- **Stage 1: Alarm**
 - When first dealing with the presence of stress, the body mobilises its resources and primes itself for a “fight-or-flight”-type response.
 - This implicates the release of hormones such as cortisol and adrenaline. Cortisol stimulates the release of glucose from the glycogen reserves in the liver; adrenalin increases the levels of glucose in the blood. As such, both hormones increase the body's readily available energy supply. Concurrently, the sympathetic nervous system is activated.

- **Stage 2: Resistance**

- The body continues to mobilise its resources to fight against the stressor, causing blood glucose levels to remain high, with cortisol and adrenalin at elevated levels. Heart rate, blood pressure and breathing frequency are increased as well
- The parasympathetic nervous system retakes control from the sympathetic nervous system, so that the outward appearance of organism seems normal.
- Nevertheless, the body remains on red alert.

- **Stage 3: Exhaustion**

- If the stress continues to hold on, the organism will eventually exhaust its resources and becomes susceptible to disease and death.
- The alternative is that the body adapts to the stressful conditions that plague it. In that case, the stress will gradually diminish because of the adaptation.



In the past four years we have drilled

81,000 km

That's more than **twice** around the world.

Who are we?
We are the world's leading oilfield services company. Working globally—often in remote and challenging locations—we invent, design, engineer, manufacture, apply, and maintain technology to help customers find and produce oil and gas safely.

Who are we looking for?
We offer countless opportunities in the following domains:

- Engineering, Research, and Operations
- Geoscience and Petrotechnical
- Commercial and Business

If you are a self-motivated graduate looking for a dynamic career, apply to join our team.

What will you be?

Schlumberger

careers.slb.com

Click on the ad to read more

This three-stage process is known as the general adaptation syndrome (GAS). Its central concept is that stress keeps a body away from maintaining homeostasis, and that the body needs to adapt to the stress conditions in order to escape it. In biology, most biochemical processes strive to maintain equilibrium, a steady state that exists more as an ideal and less as an achievable condition. However, environmental factors, internal or external stimuli, continually counteract this tendency to achieve homeostasis. The more intense the stress, the more a body is removed from this ideal condition, and the more energy and resources it needs to invest to achieve it. If it wants to win this battle, it needs to shift the (homeostatic) equilibrium to a point where the stress is no longer a threat. Exhaustion then only occurs when the stress is too large for adaptation to occur, or when that new equilibrium point is unattainable.

The GAS is thought to be the main reason why stress is an underlying cause of many health problems. By changing the way our body normally functions, stress disrupts the natural balance – the homeostasis – crucial for well-being.

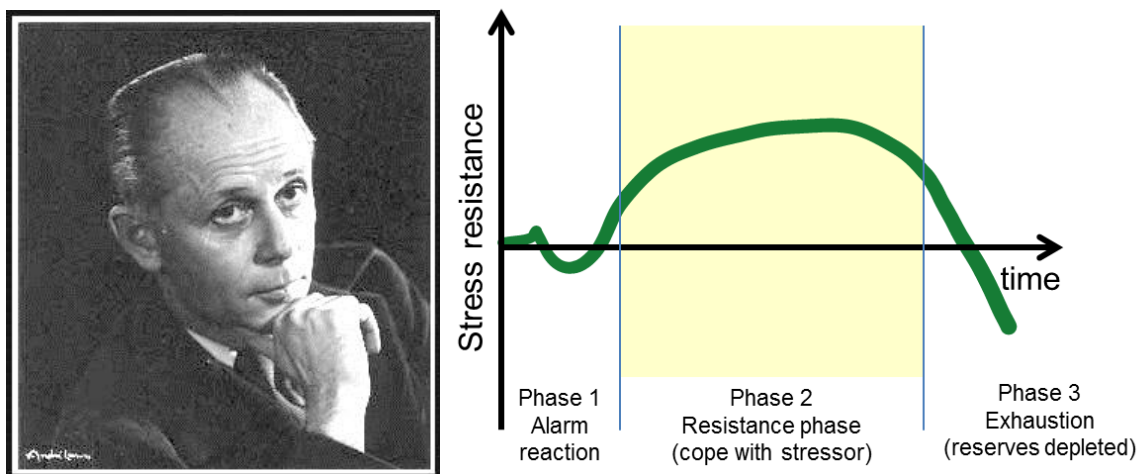

Figure 2-30. Hans Selye (left) and his General Adaptation Syndrome model (right).

2.7.2 Growth and development

An easy variable to measure is the size of an organism, and how this size changes (i.e. the organism grows). In addition, growth is a variable that is heavily influenced by the biochemical and physiological condition of the organism under study. Hence, the growth rate of an organism easily serves as a reliable biomarker for pollution exposure as well.

Overall, pollution has a growth retardant effect, albeit that the dose-response relation between both often exhibits a response threshold. On the other hand, it has often been established that a low dose of a pollutant (or even more generally, a stressor) actually stimulates growth. That effect is called **hormesis** (Figure 2-31). This occurs in response to different pollutants, such as heavy metals (Lefcort et al. 2008).

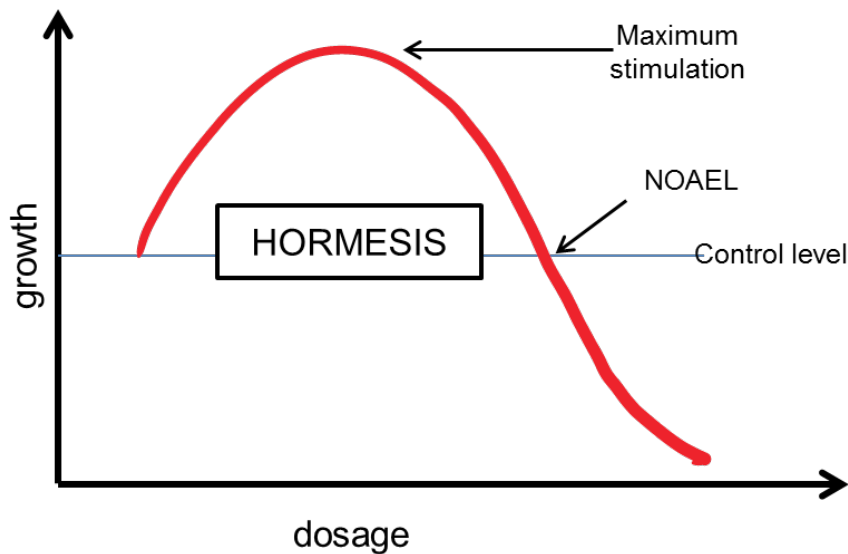

Figure 2-31. Hormesis: growth stimulation by stress
Dose-response curve depicting characteristics of the chemical hormetic zone (modified from Calabrese and Baldwin, 1997). Abbreviations: NOAEL = no observed adverse effect level; LOAEL = lowest observed adverse effect level; ZEP = zero equivalent point.

A second measure on the organismal level is the so-called **scope for growth (SFG)**, which is equal to the amount of energy which is not needed for defence and xenobiotic detoxification, and can therefore be used for growth and development (Widdows and Shick 1985). As such, the SFG offers a way to integrate a wide variety of possible cellular responses (both detrimental and beneficial). To assess the SFG, several physiological parameters were measured and converted into energy equivalents:

$$C = P + R + U + F$$

where C = total consumption of food energy; P = production of both somatic tissue and gametes; R = respiratory energy expenditure; U = energy lost as excreta; F = faecal energy loss. In a second step, SFG is calculated as follows:

$$\text{SFG} = A - (R + U)$$

where A, the absorbed part is calculated as the product of consumption, C, and the efficiency of absorption of energy from the food, aE. The latter was in turn computed as

$$aE = (f - e) / [(1 - e) * f]$$

where f and e are the ash-free dry weight:dry weight ratio of food and faeces, respectively. Formulas and description were taken directly from Okumuş and Stirling (1994). Examples of how pollution may affect the SFG is given in Figure 2 32, Figure 2 34 and Figure 2 34.

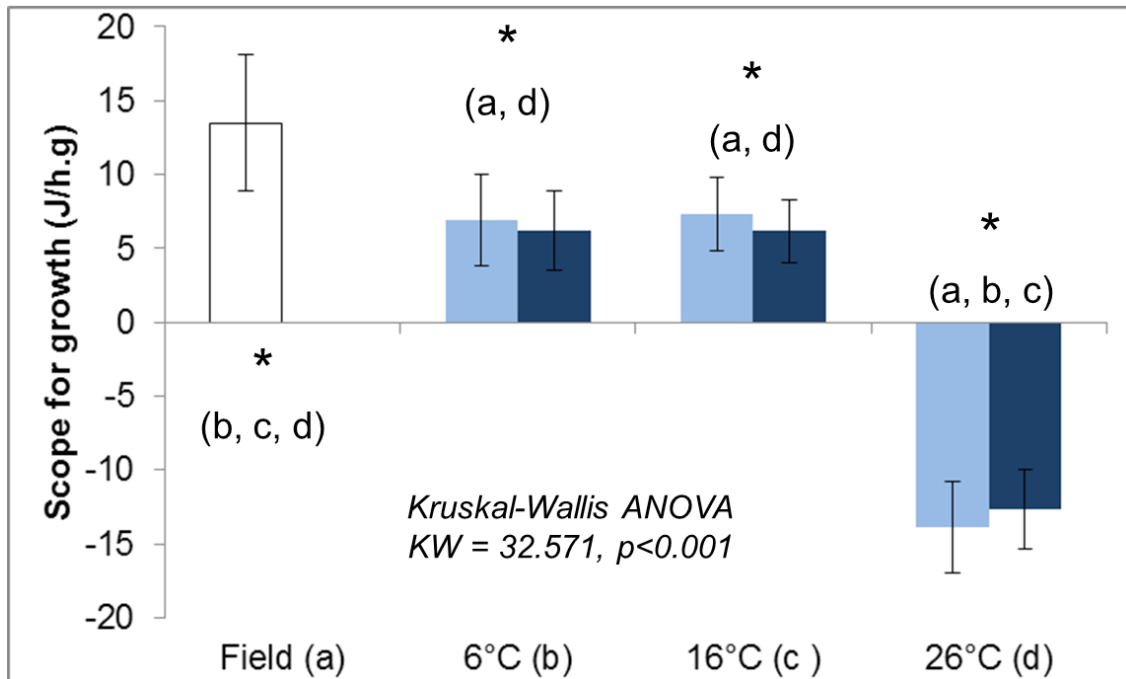

Figure 2-32. SFG of mussels. White bars represent field values, crossed bars values after an acclimation period and shaded bars values at the end of the experiment. Marked values are significantly different ($p < 0.05$, Kruskal–Wallis with post-hoc) from a specific treatment denoted by the subscript. Taken from Mubiana and Blust (2007).

An alternative measure is the **cellular energy allocation (CEA; De Coen and Janssen 1997)**. This assesses the changes in the biochemical energy reserves E_a (total carbohydrate, protein and lipid content) of an organism, as well as its energy consumption E_c (electron transport activity). CEA is then calculated as follows:

$$CEA \left(\frac{\text{mJ}}{\text{organism}} \right) = \frac{\int_0^{96 \text{ h}} E_a \cdot dt - \int_0^{96 \text{ h}} E_c \cdot dt}{96 \text{ h}}$$

Both CEA and SFG can be taken together to obtain a more complete image of the effect of a certain pollutant (Figure 2-33).

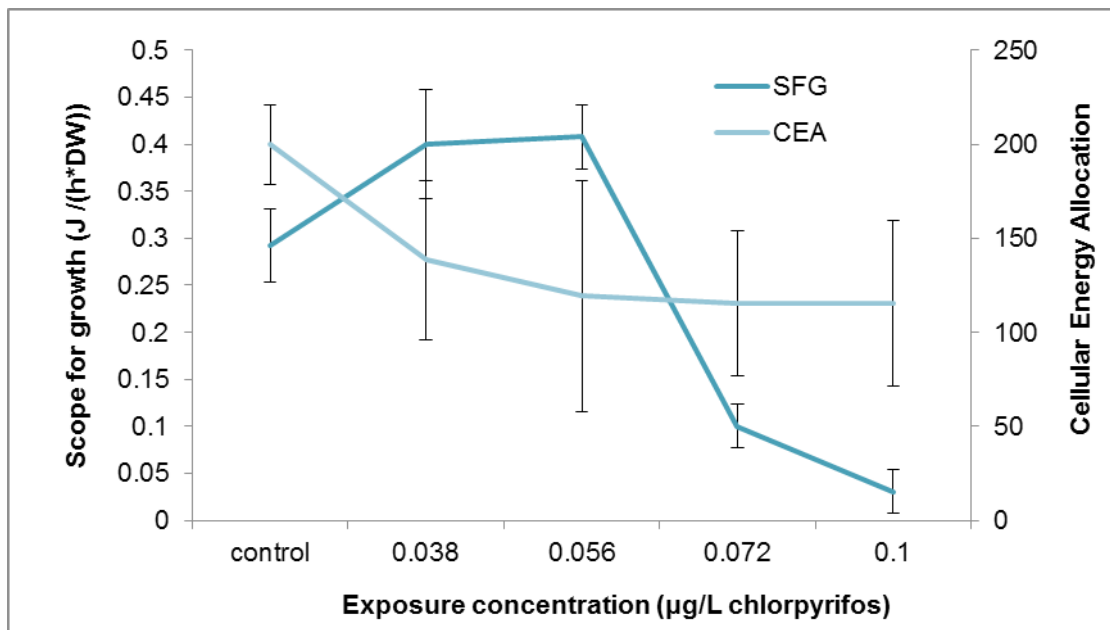

Figure 2-33. Scope for growth (SFG) and cellular energy allocation (CEA) of *Neomysis integer* (Crustacea: Mysidacea) following exposure to chlorpyrifos. Data pooled from SFG calculated after 48, 96 and 168 h and CEA calculated after 48 and 168 h. Error bars correspond to standard deviations of the mean. *Significantly different from control (*p < 0.05, **p < 0.01). Taken from Verslycke et al. (2004).



Hellmann's is one of Unilever's oldest brands having been popular for over 100 years. If you too share a passion for discovery and innovation we will give you the tools and opportunities to provide you with a challenging career. Are you a great scientist who would like to be at the forefront of scientific innovations and developments? Then you will enjoy a career within Unilever Research & Development. For challenging job opportunities, please visit www.unilever.com/rjobs.

Could it be 
Unilever



 [Click on the ad to read more](#)

When it is known what the impact of a certain type of pollution is known on the SFG, scientists can also use this parameter to investigate the possible presence of hitherto unknown compounds. This is represented in the graph of Figure 2-34: the left bar represents the SFG for mussels (*Mytilus edulis*) in an unpolluted environment, the middle bar gives the SFG in a moderately polluted area (with a well-known exposure to hydrocarbons and tributyltin), and the right bar does this for a newly investigated area where the same compounds of the previous site are present, plus a set of unknowns. Due to these unknowns, the SFG is affected more than could be predicted based on the concentrations and established effects of hydrocarbons and tributyltin alone. This warrants further study and the need to get to know these unknown pollutants.

In a number of cases, the pollution will cause specific anatomical defects, like scoliosis (lateral curvature of the spine) and lardosis (extreme forward curve of the spine) (Figure 2-35).

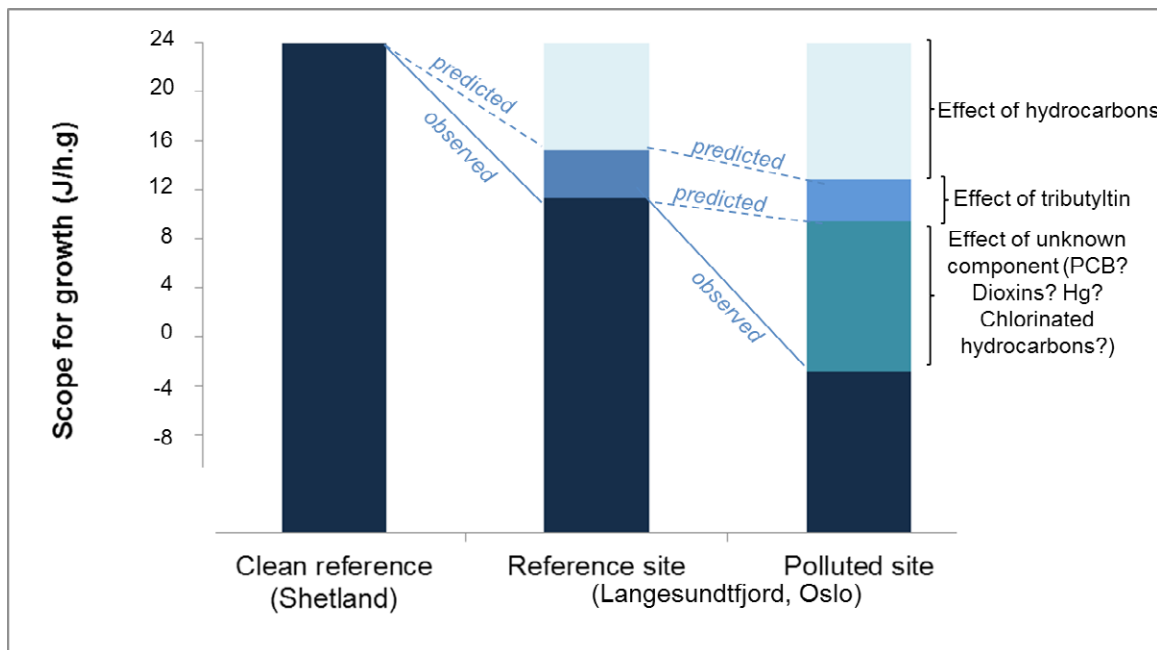

Figure 2-34. Effect of pollution on Scope for Growth. SGF of *Mytilus edulis* from Langesundtjord in comparison to a “clean reference site” in the Shetland Islands. And a second reference site in the Langesundtjord. Data from Widdows and Johnson, 1988; Figure taken from Widdows and Donkin (1991).

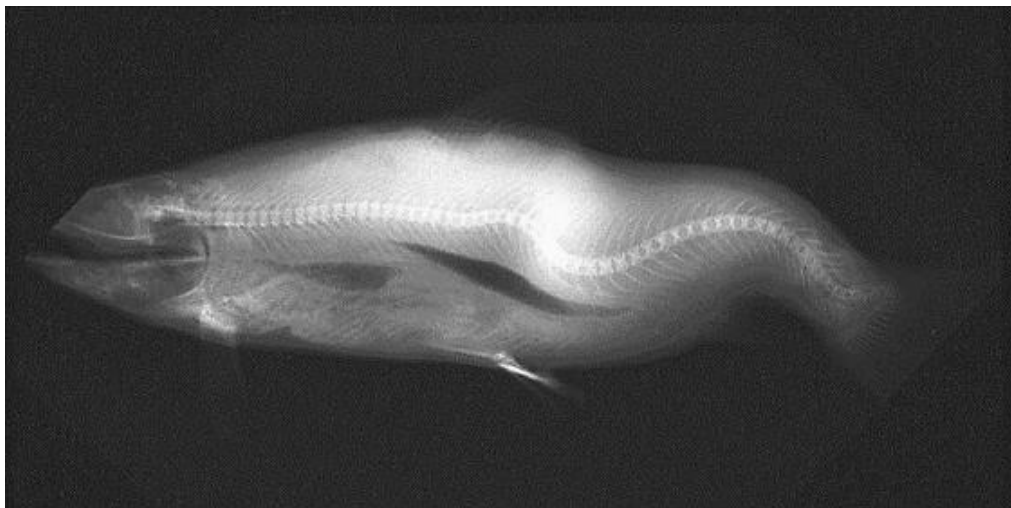

Figure 2-35. Atlantic salmon smolt with spinal deformities
(Taken from Silverstone and Hammell 2002)

2.7.3 Biomarkers on the organismal level: Endocrine disruptors

The coordination of the response of a living being to its environment occurs in two ways. On the one hand, there is the nervous system, which transfers sensory stimuli rather quickly: pain, odours, tastes, visual and auditory elements. Nerve signals trigger immediate reactions of specific cells and tissues (e.g. muscles). On the other hand, there are the hormones – a number of small and larger molecules, which are able to affect the general physiology of a cell or an organ on a longer term, and which are responsible for the regulation of more general processes like general metabolism, growth and organ differentiation, defences, behaviour and reproduction. Hormones play also an important role in shaping a developing living being during its embryonic and foetal stages, for example by directing the development of sexual characteristics and gender identity.

Hormone	Origin	Function
Adrenaline	adrenal gland	Fight or flight response Stress See also 2.7.1
Insulin	pancreas	Glucose uptake
Thyroxin	thyroid gland	General metabolism
Oestradiol	ovaries	development of female sexual secondary characteristics
Testosterone	testicles and ovaries, adrenal glands	Development of muscle mass; androgenic development

Table 2-7. A number of well-known examples of hormones.

Hormones are being produced in specific places (glands) in the organism. The vertebrate pancreas produces insulin, insect larvae develop because of a finely tuned production of ecdyson, the thyroid gland produced thyroxin. From there, the hormones are released into the bloodstream (a process called endocrine secretion), so that the compounds can travel through the body and reach their target cells. These target cells contain receptor proteins, allowing them to sense the presence and the quantity of a specific hormone. These receptors are found as integral proteins in the plasma membrane or as free proteins in the cytoplasm. In each case, the receptor will send out a signal as soon as it binds with the hormone. Through a cascade of intermediary proteins and signal molecules, the signal will reach the nucleus and activate the proper genes, leading to a suitable response (Figure 236).

The hormonal system must be very specific in its responses. There are tens of thousands different chemicals that come into contact with our cells; still, the receptors are usually capable to recognise the specific chemical structure of that one compound that is an active hormone. However, mistakes are not impossible. Very closely related chemicals are able to trigger the same actions as the normal hormones would do, causing a number of metabolic malfunctions (Safe and Gaido 2009). We call them pseudohormones. Other compounds bind to the receptor in such a way that there are no further responses possible from that receptor. They are called antagonists.



Discover the truth at www.deloitte.ca/careers

Deloitte.

© Deloitte & Touche LLP and affiliated entities.



Click on the ad to read more

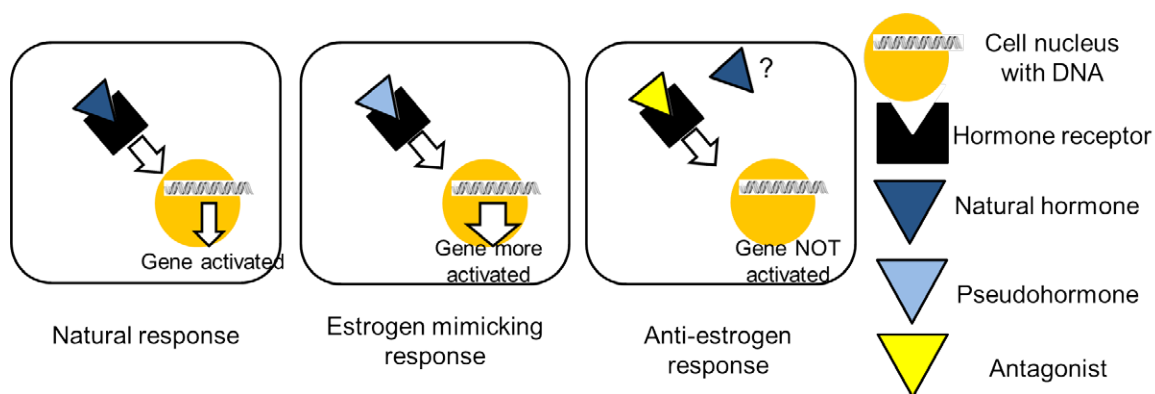

Figure 2-36. Action of hormones (left), pseudohormones (middle) and hormone antagonists (right).

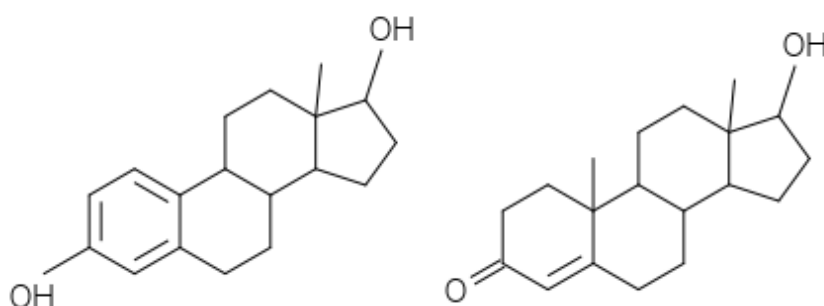

Figure 2-37. The typical female (left) and male (right) sex hormones in vertebrates.

Several decades ago, such malfunctions were found to occur in the reproductive system of a number of animals, including mankind itself: a lower fertility, disruption of gender-related behaviour, and even the occurrence of sex-changing individuals (a condition indicated with the term “imposex”). In mankind, there was a significant increase in the incidence of breast and prostate cancer, and decreases in sperm quality and quantity. These changes are due to the occurrence of high levels of oestrogens in the environment (due to a high consumption of oestrogen and progesterone in the female contraceptive pills), or to a high exposure to so-called estrogenic chemicals (xenobiotics, often of a very different chemical nature, that mimic the action of normal oestrogens). The source of these compounds in many instances anthropogenic.

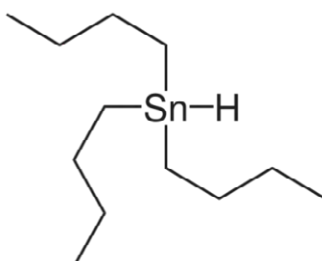

Figure 2-38. Tributyltin

One of the worst examples is the synthetic oestrogen diethylstilboestrol (DES), prescribed to pregnant women to avoid spontaneous abortion, caused a frequent occurrence of a clear-cell carcinoma, a very rare vaginal cancer, during the puberty of their daughters. The male children were afflicted with morphological alterations of the penis (such as hypospady, a condition where the urethra does not end at the tip, but elsewhere on the organ), the formation of cysts, and diminished sperm quality.

A typical maritime example is the organometallic compound tributyltin (TBT, Figure 2-38; reviewed by Santillo et al. (2001) or by Antizar-Ladislao (2008)). Since the 1960s, the compound was added to paints as an antifouling agent⁴. It was also used as a fungicide in textile production and industrial water systems, such as cooling towers and refrigeration water systems, wood pulp and paper mill systems, and breweries. By the 1970s, most seagoing vessels had TBT painted on their hulls.

Oestrogenic and antioestrogenic effects	
HIGH	diethylstilboestrol (DES)
HIGH	ethinyl oestradiol (active component in the “pill”)
MEDIUM	phytoestrogens:
	isoflavones
	coumestans
	lignans
LOW	bisphenol A
LOW	octylphenol, nonylphenol
LOW	pesticides, such as DDT, dieldrin, toxaphene
Androgenic receptor antagonists	
	DDE
	phthalates such as DBP, DEHP
	pesticides such as linuran, procymidone
	hydroxyflutamide
Others	
	Dioxins, furans, dioxin-like PCBs

Table 2-8. Overview of potential pseudohormones and hormone antagonists

Unfortunately, TBT has a lot of negative effects on marine life (Table 2-9). TBT causes imposex in marine snails (Blaber 1970; Oehlmann et al. 1991; Ten Hallers-Tjabbes et al. 1994; Bettin et al. 1996), even at ng/L levels. In areas of heavy shipping, where a lot of TBT has been released, gastropod populations have been decimated due to the impossibility to reproduce properly. Moreover, TBT causes a reduced growth and a faulty development (Liu et al. 2012) in invertebrates, killed off oyster larvae (Ruiz et al. 1998). Both tributyltin and its metabolic derivative dibutyltin, cause immunosuppression in marine mammals. The compound is linked to the death of a number of dead sea otters (*Enhydra lutris*) and bottlenose dolphins between 1992 and 2002, all of which had extremely high levels of tributyltin in their livers (Kannan et al. 1996, Murata et al. 2008).

TBT was therefore banned as antifouling agent in 2008, due to The Convention on the Control of Harmful Anti-fouling Systems on Ships (AFS Convention) (Gipperth 2009). This convention was adopted in 2001 under the auspices of the IMO, and forbade the use of new antifouling paint layers containing TBT since 2003. As ships renew their antifouling layers every five years while in dry-dock, the last outer layer containing TBT had to be gone by 2008. In some instances, earlier layers are still present, under the newer protective layer. Several years later, scientists in New Zealand and Europe were able to report the recovery of dog whelk populations from imposex.

Grant Thornton—^{REALLY} a great place to work.

We're proud to have been recognized as one of Canada's Best Workplaces by the Great Place to Work Institute™ for the last four years. In 2011 Grant Thornton LLP was ranked as the fifth Best Workplace in Canada, for companies with more than 1,000 employees. We are also very proud to be recognized as one of Canada's top 25 Best Workplaces for Women and as one of Canada's Top Campus Employers.



Priyanka Sawant
Manager



Audit • Tax • Advisory
www.GrantThornton.ca/Careers



© Grant Thornton LLP. A Canadian Member of Grant Thornton International Ltd



Other examples of xenobiotics influencing the hormonal coordination of the reproductive system:

- Diethylstilboestrol and pentachlorophenol reduce fertility of *Daphnia magna* (Baldwin et al., 1995; Parks & LeBlanc, 1996)
- Some organophosphates reduce the levels of the reproductive hormone gonadotropin and cause reproductive problems in *Channa punctatus* (Anees 1978);
- Halogenated hydrocarbons reduce egg hatch in the flounder (*Platichthys flesus*) (Von Westernhagen et al. 1981) and other species (Von Westernhagen et al. 1987);
- Kepone causes arrest of sperm maturation and blocks a variety of “oestrogen like” effects on female reproductive systems in many fish, birds and mammals (Safe and Gaido 2009);
- Munkittrick et al. (1998) reported delayed sex maturity, smaller gonads, reduced fertility in fish populations living downstream of bleached kraft pulp mills.

Water and sediments	Tributyltin – organotin compound (TBT) is a broad spectrum algaecide, fungicide, insecticide and miticide used in anti-fouling paints since the 1960s. TBT is toxic to humans. TBT can be broken down in water under the influence of light (photolysis) and micro-organisms (biodegradation) into less toxic di- and monobutyltin. Half-life varies from a few days to a few weeks, but decomposition is slower when TBT has accumulated in sediment – if oxygen is completely excluded, TBT half-life maybe several years. Therefore waters with heavily sedimented bottoms – such as harbours, ports, estuaries – are at risk of being contaminated with TBT for several years.
Shell malformations	TBT causes thickening of shells in sea oysters, caused by disturbance of calcium metabolism.
Imposex	Recorded in marine snails: females develop male sexual characteristics. Imposex has been recorded in 72 marine species. Concentration of just 2.4 nanograms of TBT per litre needed to produce sexual changes in dog-whelks, leading to sterility.
Marine mammals	Traces of TBT have been found in whales, dolphins and members of the seal family in the United States, south-east Asia, the Adriatic Sea and the Black Sea. The TBT is absorbed via the food chain.
Reduced resistance to infection	Research has shown TBT reduces resistance to infection in fish such as flounder and other flatfish which live on seabed and are exposed to relatively high levels of TBT, especially around areas with silty sediment like harbours and estuaries.

Table 2-9. Tributyltin (TBT) – harmful effects on the environment (IMO, 2002)

Ref: TBT in antifouling paints: National Institute for Coastal and Marine Management/RIKZ, Netherlands. MEPC 42/Inf.10

2.7.4 Behaviour

Pollutant levels may also, as a final effect on the organismal level, affect the behaviour of the marine organisms. As a result, the organisms will:

- change their responses to environmental stimuli, preferences and avoidances;
 - e.g. salmon changes its temperature preference from 19.1°C to 23.4°C as a result of DDT in the environment.

- become less active and fatigues or rather hyperactive,
e.g. mysid shrimp (Roast et al. 2000) or *Cyprinus carpio* (carp; Halappa and David 2009)
become hyperactive upon contact with the pesticide chlorpyrifos.
e.g. Mercury, DDT and carbaryl made golden shiners become hyperactive and reduced their shoal cohesion after detection of a predator (Weis and Weis 1974a,b, Webber and Haines 2003)
- alter their feeding patterns,
e.g. Cd and Zn exposure forces shellfish (such as the Asiatic clam *Corbicula fluminea*) to close its shell and stop filter feeding (Doherty et al. 1987)
- be unable to maintain optimal performance levels (e.g. swimming speed, predator success, grazing).
For example: chlorpyrifos decreased the top speed of swimming mysids (Roast et al. 2000).
Burrowing is reduced in *Donax trunculus* after Cd exposure (Neuberger-Cywiak et al. 2003).
- have a decreased reproduction success due to altered mating behaviour
E.g. in male medakas after TBT exposure (Table 210);
e.g. in *Gammarus pulex*, disrupts precopulatory pairing (Poulton and Pascoe 1990)

Treatment	Number of male medakas that performed			
	Following	Dancing	Crossing	Mating
Control	12	9	6	6
TBT	8	5	3	3
PCBs	12	10	7	6
TBT + PCBs	5**	3*	2	2

Table 2-10. Sexual behaviour changes of male medakas treated with TBT and/or PCBs

(N=12 per treatment group) – Taken from Nakayama et al.2004

*:Significantly different ($p < 0.05$, the Fisher's exact test) from control value.

** : Significantly different ($p < 0.01$, the Fisher's exact test) from control value.

2.8 Effects on ecosystems

Lastly, one can investigate changes that affect the complete ecosystem: community structure, biodiversity, the vertical distribution of macrofauna,... In general, pollution causes three main changes on the ecosystem level:

- A reduction in diversity (2.8.1)
- Opportunist species become dominant (again) (2.8.1)
- The dominant species undergo a reduction in size due to changes in energy metabolism and cycling (2.7.2) which then alters the competition in the community.

2.8.1 Measuring biodiversity and species composition

Biodiversity is assessed with the aid of a number of indices.

The first one is the most simple: it is **species richness S or SR**, the number of species in a certain area. Whittaker (1972) distinguished between four different levels of species richness, each measured at its own scale:

- point diversity or the diversity measured in a single sample,
- alpha diversity or the average diversity in a number of samples within a habitat,
- gamma diversity (the diversity of a larger unit, with different habitats, such as an island or landscape)
- and finally epsilon or regional diversity (the total diversity of a group of areas of gamma diversity).

Gray (2000) suggested to call these respectively:

- Point species richness SR_p
- Sample species richness SR_s
- Large area species richness SR_L
- Biogeographical province species richness SR_B

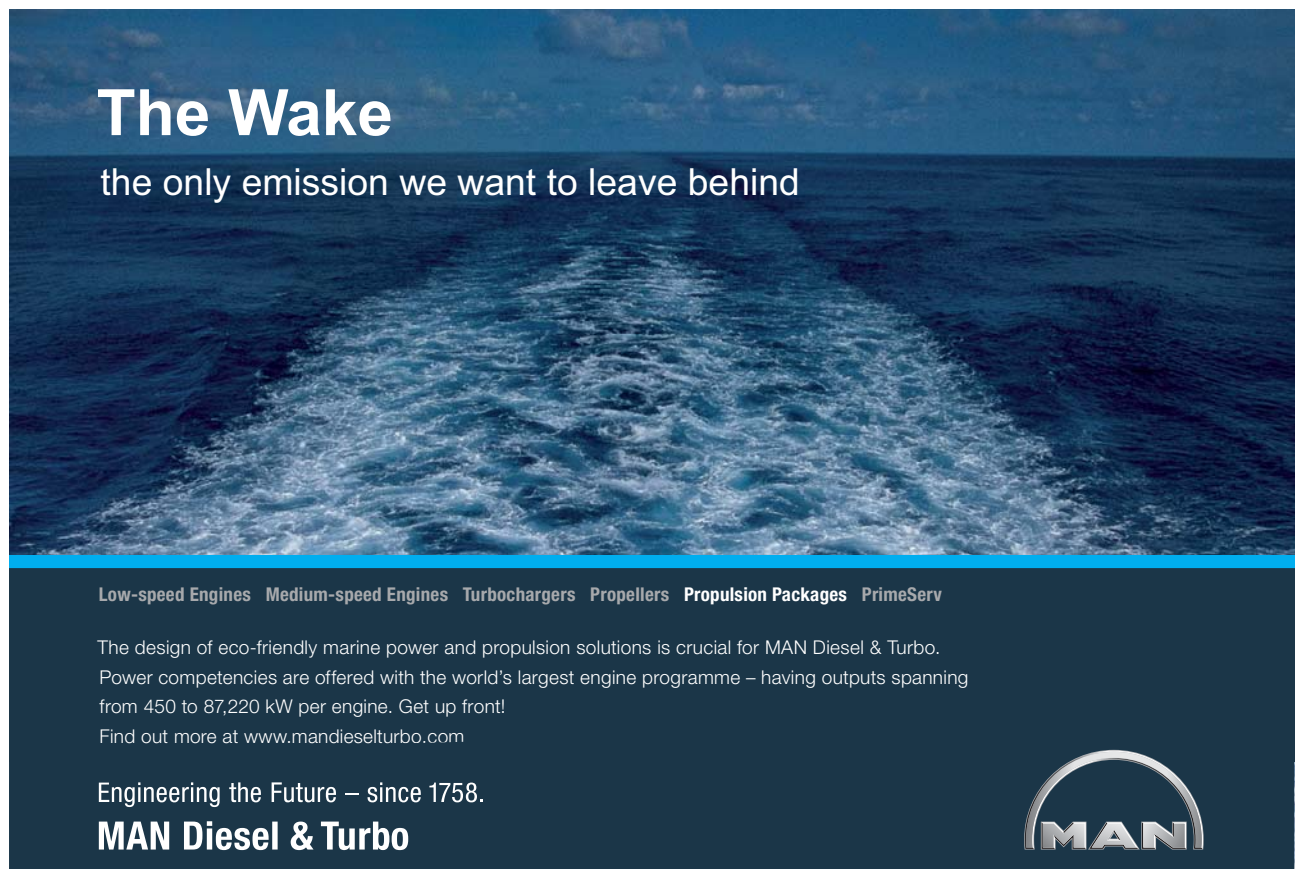

The Wake
the only emission we want to leave behind

Low-speed Engines Medium-speed Engines Turbochargers Propellers Propulsion Packages PrimeServ

The design of eco-friendly marine power and propulsion solutions is crucial for MAN Diesel & Turbo. Power competencies are offered with the world's largest engine programme – having outputs spanning from 450 to 87,220 kW per engine. Get up front!
Find out more at www.mandieselturbo.com

Engineering the Future – since 1758.
MAN Diesel & Turbo



For practical reasons one would ideally include all life forms in an assessment of species richness. However, both for practical reasons and because in many cases, the bacterial species will be difficult to identify, the microscopic level is often neglected. The fauna retained on a 0.5 or 1 mm sieve will therefore often be referred to as **macrofauna** and those passing through this sieve but are retained on a 0.62 mm sieve as **meiofauna**. Additionally, studies will focus on a certain taxon, as a proper determination requires a certain degree of expertise in that taxon (Gray 2000).

The main disadvantage of reporting simply the number of species in a sample is that the index depends on sample size and sampling effort. Two indices that try to remedy this problem are **Margalef's diversity index**

$$D_{Mg} = \frac{S - 1}{\ln N}$$

and **Menhinick's diversity index**:

$$D_{Mn} = \frac{S}{\sqrt{N}}$$

with S again the number of species that was observed and N the number of individuals in the sample.

A second measurement is aimed to assess diversity. The most widely used in ecology is undoubtedly the **Shannon-Wiener diversity index H'**.

$$H' = - \sum_{i=1}^S p_i \cdot \ln p_i$$

p_i is here the relative abundance of a given species, calculated as the ratio between the number of individuals in the sample belonging to that species (n_i) and the total number of individuals in the sample, or:

$$p_i = n_i/N$$

Diversity is also measured using the Brillouin diversity index:

$$H = \frac{1}{N} \ln \frac{N!}{\prod_{i=1}^S n_i!}$$

A third aspect is the species **evenness** E (also known as Pielou's evenness):

$$E = \frac{H'}{H'_{max}}$$

with

$$H'_{max} = - \sum_{i=1}^S \frac{1}{S} \cdot \ln \frac{1}{S} = \ln S$$

Evenness is a number between 0 and 1. A low evenness points at a community that is dominated by one or a few species; a high evenness indicates that there are more or less an equal amount of individuals from each organism.

Examples of these indices are given in Table 2-11.



CAREER KICKSTART

An app to keep you in the know

Whether you're a graduate, school leaver or student, it's a difficult time to start your career. So here at RBS, we're providing a helping hand with our new Facebook app. Bringing together the most relevant and useful careers information, we've created a one-stop shop designed to help you get on the career ladder – whatever your level of education, degree subject or work experience.

And it's not just finance-focused either. That's because it's not about us. It's about you. So download the app and you'll get everything you need to know to kickstart your career.

So what are you waiting for?

Click [here](#) to get started.



Parameters	Locations						
	A	B	C	D	E	F	G
Distance from watergate (km) (see map below)	0.5	1	1	1.5	2	2.5	3
<i>Sediment metal concentrations (ppm)</i>							
Cu.	269	78	61	48	44	32	25
Zn	348	166	154	130	137	106	98
Cr	229	95	75	77	75	75	64
Ni	83	60	60	53	57	51	48
Pb	62	33	35	31	34	28	27
Cd	0.42	0.37	0.36	0.34	0.34	0.34	0.33
Mn	611	592	714	570	756	721	743
<i>Community details</i>							
No of species	4	3	17	19	15	22	26
Total Density (indiv/m ²)	2080	529	1710	5390	4940	10200	10100
Total Biomass (g wet weight/m ²)	5.9	0.8	123	70.3	77.5	805	1110
Biomass per individual (mg wet weight/indiv.)	2.8	1.5	71.9	13.0	15.7	78.9	110
<i>Ecological indices</i>							
Shannon–Wiener diversity	0.20	0.60	1.77	2.23	1.57	1.80	1.59
Margalef's richness	0.39	0.32	2.15	2.10	1.65	2.28	2.71
Pielou's evenness	0.15	0.55	0.62	0.76	0.58	0.58	0.49

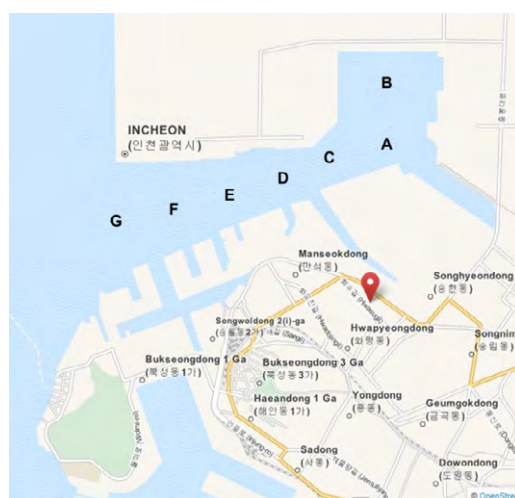

Table 2-11. Study of metal pollution and ecosystem structure in Seoul, Korea
Taken from Ryu et al., 2011. Map courtesy of OpenStreetMap (www.openstreetmap.org)

2.8.2 Trends expected in stressed ecosystems

On a more functional level, Odum (1985) presented a list of possible changes due to an increase in stress (for example due to exposure of pollutants) on an ecosystem:

Energetics

1. Community respiration increases
2. The equilibrium between production/respiration becomes unbalanced and deviates from 1.
3. The equilibrium between production and standing biomass, or between respiration and standing biomass increases. Maintenance becomes more important.
4. Importance of auxiliary energy (from outside of the ecosystem) increases
5. Exported or unused primary production increases

Nutrient cycling

6. Nutrient turnover increases
7. The cycling of nutrients decreases
8. Nutrient loss increases (the system becomes more “leaky”)

Community structure

9. Proportion of r-strategists (organisms that produce a lot of offspring that will mostly die before adulthood) increases
10. Size of organisms decreases
11. Lifespans of organisms or parts (leaves, for example) decrease
12. Food chains shorten because of reduced energy flow at higher trophic levels and/or greater sensitivity of predators to stress
13. Species diversity decreases and dominance increases; if original diversity is low, the reverse may occur; at the ecosystem level, redundancy of parallel processes theoretically declines

General system-level trends

14. Ecosystem becomes more open (i.e., input and output environments become more important as internal cycling is reduced)
15. Autogenic successional trends reverse (succession reverts to earlier stages)
16. Efficiency of resource use decreases
17. Parasitism and other negative interactions increase, and mutualism and other positive interactions decrease
18. Functional properties (such as community metabolism) are more robust (homeostatic-resistant to stressors) than are species composition and other structural properties

2.9 Read more?

2.9.1 Articles and books

Anees, M.A. (1978). *Channa punctatus* (Bloch) exposed to sub-lethal and chronic levels of three organophosphorus insecticides. *Bulletin of environmental contamination and toxicology*, 19(1), 524–527.

Antizar-Ladislao, B. (2008). Environmental levels, toxicity and human exposure to tributyltin (TBT)-contaminated marine environment. A review. *Environment International*, 34(2), 292–308.

Au, D.W.T. (2004). The application of histo-cytopathological biomarkers in marine pollution monitoring: a review. *Marine pollution bulletin*, 48(9), 817–834.

Baldwin, W.S., Milam, D.L., & Leblanc, G.A. (1995). Physiological and biochemical perturbations in *Daphnia magna* following exposure to the model environmental estrogen diethylstilbestrol. *Environmental Toxicology and Chemistry*, 14(6), 945–952.

Beaumont, A.R., & Newman, P.B. (1986). Low levels of tributyl tin reduce growth of marine micro-algae. *Marine pollution bulletin*, 17(10), 457–461.

ORACLE®

Be BRAVE

enough to reach for the sky

Oracle's business is information - how to manage it, use it, share it, protect it. Oracle is the name behind most of today's most innovative and successful organisations.

Oracle continuously offers international opportunities to top-level graduates, mainly in our Sales, Consulting and Support teams.

If you want to join a company that will invest in your future, Oracle is the company for you to drive your career!

<https://campus.oracle.com>



ORACLE®

ORACLE IS THE INFORMATION COMPANY



- Bettin, C., Oehlmann, J., & Stroben, E. (1996). TBT-induced imposex in marine neogastropods is mediated by an increasing androgen level. *Helgoland Marine Research*, 50(3), 299–317.
- Blaber, S.J. (1970). The occurrence of a penis-like outgrowth behind the right tentacle in spent females of *Nucella lapillus* (L.). *Journal of Molluscan Studies*, 39(2-3), 231–233
- Bohne-Kjersem, A., Bache, N., Meier, S., Nyhammer, G., Roepstorff, P., Sæle, Ø., Goksøyr A. & Grøsvik, B.E. (2010). Biomarker candidate discovery in Atlantic cod (*Gadus morhua*) continuously exposed to North Sea produced water from egg to fry. *Aquatic Toxicology* 96(4), 280–289.
- Calabrese, E.J., & Baldwin, L.A. (1997). A quantitatively-based methodology for the evaluation of chemical hormesis. *Human and Ecological Risk Assessment*, 3(4), 545–554.
- Calabrese, E.J., & Baldwin, L.A. (2000). Chemical hormesis: its historical foundations as a biological hypothesis. *Human & experimental toxicology*, 19(1), 2–31.
- Calabrese, E.J., & Baldwin, L.A. (1997). The dose determines the stimulation (and poison): development of a chemical hormesis database. *International Journal of Toxicology*, 16(6), 545–559.
- Carvalho, R.N., Bopp, S.K., & Lettieri, T. (2011). Transcriptomics responses in marine diatom *Thalassiosira pseudonana* exposed to the polycyclic aromatic hydrocarbon benzo [a] pyrene. *PloS one*, 6(11), e26985. doi:10.1371/journal.pone.0026985
- Chapman, P.M. (1995). Ecotoxicology and pollution – Key issues. *Marine Pollution Bulletin*, 31(4), 167–177.
- Chen, X., Zhou, Y., Yang, D., Zhao, H., Wang, L., & Yuan, X. (2012). CYP4 mRNA expression in marine polychaete *Perinereis aibuhitensis* in response to petroleum hydrocarbon and deltamethrin. *Marine Pollution Bulletin* 64, 1782–1788.
- De Coen, W.M., & Janssen, C.R. (1997). The use of biomarkers in *Daphnia magna* toxicity testing. IV. Cellular Energy Allocation: a new methodology to assess the energy budget of toxicant-stressed *Daphnia* populations. *Journal of Aquatic Ecosystem Stress and Recovery (Formerly Journal of Aquatic Ecosystem Health)*, 6(1), 43–55.
- Doherty, F.G., Cherry, D.S., Cairns J., jr. (1987) Valve closure responses of the Asiatic clam *Corbicula fluminea* exposed to cadmium and zinc. *Hydrobiologia* 153, 159–167.

- Feder, M.E., & Hofmann, G.E. (1999). Heat-shock proteins, molecular chaperones, and the stress response: evolutionary and ecological physiology. *Annual review of physiology*, 61(1), 243–282.
- Fent, K., & Stegeman, J.J. (1993). Effects of tributyltin in vivo on hepatic cytochrome P450 forms in marine fish. *Aquatic toxicology*, 24(3), 219–240.
- Gao, A., Wang, L., & Yuan, H. (2012). Expression of metallothionein cDNA in a freshwater crab, *Sinopotamon yangtsekiense*, exposed to cadmium. *Experimental and Toxicologic Pathology*, 64(3), 253–258.
- Gipperth, L. (2009). The legal design of the international and European Union ban on tributyltin antifouling paint: Direct and indirect effects. *Journal of environmental management*, 90, 86–95.
- Goksøyr, A. (1995). Cytochrome P450 in marine mammals: isozyme forms, catalytic functions, and physiological regulations. *Developments in Marine Biology*, 4, 629–639.
- Goksøyr, A. & Förlin, L. (1992). The cytochrome P450 system in fish, aquatic toxicology and environmental monitoring. *Aquatic Toxicology*, 22, 287–312.
- Gray, J.S. (2000). The measurement of marine species diversity, with an application to the benthic fauna of the Norwegian continental shelf. *Journal of Experimental Marine Biology and Ecology* 250, 23–49.
- Halappa, R., & David, M. (2009). Behavioral Responses of the Freshwater Fish, *Cyprinus carpio* (Linnaeus) Following Sublethal Exposure to Chlorpyrifos. *Turkish Journal of Fisheries and Aquatic Sciences*, 9(2), 233–238.
- ICCVAM (2001). The Revised Up-and-Down Procedure: A Test Method for Determining the Acute Oral Toxicity of Chemicals. NIH publication 02-4501. National Institute of Environmental Health Sciences. Research Triangle Park, NC.
- Kannan, K., Senthilkumar, K., Loganathan, B.G., Takahashi, S., Odell, D. K., & Tanabe, S. (1996). Elevated accumulation of tributyltin and its breakdown products in bottlenose dolphins (*Tursiops truncatus*) found stranded along the US Atlantic and Gulf coasts. *Environmental science & technology*, 31(1), 296-301.
- Lefcort, H., Freedman, Z., House, S., & Pendleton, M. (2008). Hormetic effects of heavy metals in aquatic snails: is a little bit of pollution good? *EcoHealth*, 5(1), 10–17.

Liu, J., Cao, Q., Yuan, J., Zhang, X., Yu, L., & Shi, H. (2012). Histological observation on unique phenotypes of malformation induced in *Xenopus tropicalis* larvae by tributyltin. *Journal of Environmental Sciences*, 24(2), 195–202.

López-Barea, J., & Pueyo, C. (1998). Mutagen content and metabolic activation of promutagens by molluscs as biomarkers of marine pollution. *Mutation Research/Fundamental and Molecular Mechanisms of Mutagenesis*, 399(1), 3–15.

Lowe, D.M., & Moore, M.N. (1979). The cytology and occurrence of granulocytomas in mussels. *Marine Pollution Bulletin*, 10(5), 137–141.

Magurran, A.E. (2004). *Measuring biological diversity*. Blackwell Publishing: Oxford, UK. 256 p.

Michener, R.H., & Kaufman, L. (2007). Stable isotope ratios as tracers in marine food webs: an update. In R. Michener and K. Lajtha (Eds.). *Stable isotopes in ecology and environmental science* (2nd ed.) Blackwell Publishers, Boston, Massachusetts, p. 238–282.

Michener, R.H., & Lajtha K. (Eds.) (2007). *Stable isotopes in ecology and environmental science*. Blackwell Pub.

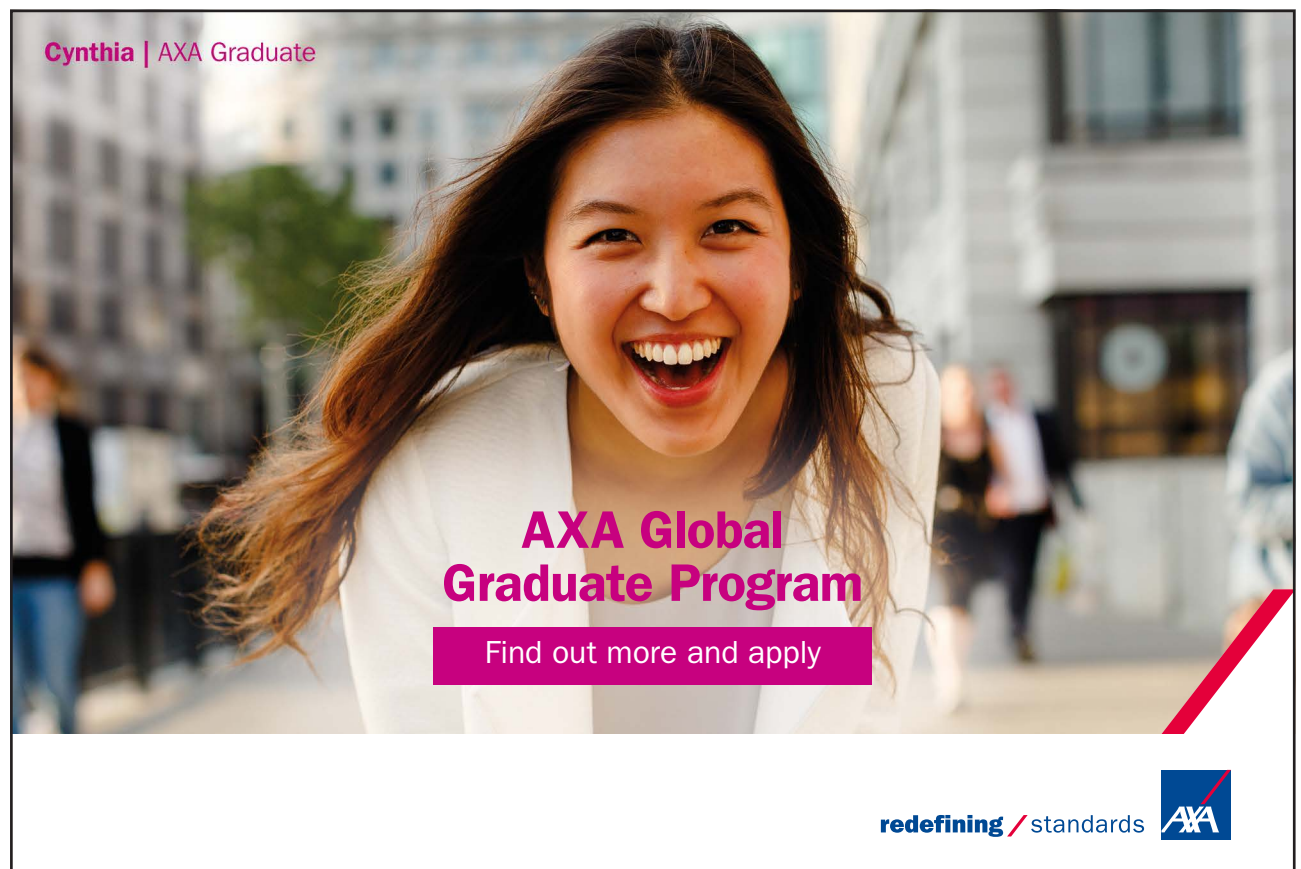

Cynthia | AXA Graduate

AXA Global Graduate Program

Find out more and apply

redefining / standards AXA

- Millero, F., & Pierrot, D. (2001). Speciation of metals in natural waters. *Geochemical Transactions*, 2(1), 57–64.
- Mubiana, V.K., & Blust, R. (2007). Effects of temperature on scope for growth and accumulation of Cd, Co, Cu and Pb by the marine bivalve *Mytilus edulis*. *Marine environmental research*, 63(3), 219–235.
- Munkittrick, K.R., McMaster, M.E., McCarthy, L.H., Servos, M. R., & Van Der Kraak, G.J. (1998). An overview of recent studies on the potential of pulp-mill effluents to alter reproductive parameters in fish. *Journal of Toxicology and Environmental Health, Part B Critical Reviews*, 1(4), 347–371.
- Murata, S., Takahashi, S., Agusa, T., Thomas, N.J., Kannan, K., & Tanabe, S. (2008). Contamination status and accumulation profiles of organotins in sea otters (*Enhydra lutris*) found dead along the coasts of California, Washington, Alaska (USA), and Kamchatka (Russia). *Marine Pollution Bulletin*, 56(4), 641–649.
- Nakayama, K., Oshima, Y., Yamaguchi, T., Tsuruda, Y., Kang, I.J., Kobayashi, M., Imada, N. & Honjo, T. (2004). Fertilization success and sexual behavior in male medaka, *Oryzias latipes*, exposed to tributyltin. *Chemosphere* 55, 1331–1337.
- Nelson, D.R., Kamataki, T., Waxman, D.J., Guengerich, F.P., Estabrook, R.W., Feyereisen, R., Gonzalez, F.J., Coon, M.J., Gunsalus, I.C., Gotoh, O., Okuda, K., & Nebert, D.W. (1993). The P450 superfamily: update on new sequences, gene mapping, accession numbers, early trivial names of enzymes, and nomenclature. *DNA and cell biology*, 12(1), 1–51.
- Neuberger-Cywiak, L., Achituv, Y., & Garcia, E.M. (2003). Effects of Zinc and Cadmium on the Burrowing Behavior, LC 50, and LT 50 on *Donax trunculus* Linnaeus (Bivalvia-Donacidae). *Bulletin of environmental contamination and toxicology*, 70(4), 713–722.
- Odum, E.P. (1985). Trends expected in stressed ecosystems. *Bioscience*, 419–422.
- Oehlmann, J., Stroben, E., & Fioroni, P. (1991). The morphological expression of imposex in *Nucella lapillus* (Linnaeus) (Gastropoda: Muricidae). *Journal of Molluscan Studies*, 57(3), 375–390.
- Okumuş, İ., & Stirling, H.P. (1994). Physiological energetics of cultivated mussel (*Mytilus edulis*) populations in two Scottish west coast sea lochs. *Marine Biology*, 119(1), 125–131.
- Parks, L.G., & LeBlanc, G.A. (1996). Reductions in steroid hormone biotransformation/elimination as a biomarker of pentachlorophenol chronic toxicity. *Aquatic toxicology*, 34(4), 291–303.

- Poulton, M., & Pascoe, D. (1990). Disruption of precopula in *Gammarus pulex* (L.) – Development of a behavioural bioassay for evaluating pollutant and parasite induced stress. *Chemosphere*, 20(3), 403–415.
- Roast S.D., Widdows J. & Jones M.B. (2000). Disruption of the swimming behavior of the hyperbenthic mysid *Neomysis integer* (Peracarida; Mysidacea) by the organophosphate pesticide chlorpyrifos. *Aquatic Toxicology*, 47, 227–241.
- Rola, R.C., Monteiro, M.D.C., Reis, S.R.D.S., & Sandrini, J.Z. (2012). Molecular and biochemical biomarkers responses in the mussel *Mytilus edulis* collected from Southern Brazil coast. *Marine Pollution Bulletin* 64, 766–771.
- Ruiz, J.M., Quintela, M., & Barreiro, R. (1998). Ubiquitous imposex and organotin bioaccumulation in gastropods *Nucella lapillus* from Galicia (NW Spain): A possible effect of nearshore shipping. *Marine Ecology Progress Series*, 164, 237–244.
- Ryu, J., Khim, J.S., Kang, S.G., Kang, D., Lee, C.H., & Koh, C.H. (2011). The impact of heavy metal pollution gradients in sediments on benthic macrofauna at population and community levels. *Environmental Pollution*, 159(10), 2622–2629.
- Safe, S.H., & Gaido, K. (2009). Phytoestrogens and anthropogenic estrogenic compounds. *Environmental toxicology and chemistry*, 17(1), 119–126.
- Santillo, D., Johnston, P., & Langston, W.J. (2001). 13. Tributyltin (TBT) antifoulants: a tale of ships, snails and imposex. In P. Harremoës et al. (Eds.) Late lessons from early warnings: the precautionary principle 1896–2000, European Environment Agency.
- Sarkar A., Ray D., Shrivastava A.N., & Sarker S. (2006) Molecular Biomarkers: Their significance and application in marine pollution monitoring. *Ecotoxicology* 15, 333–340.
- Silverstone, A.M., & Hammell, L. (2002). Spinal deformities in farmed Atlantic salmon. *The Canadian Veterinary Journal*, 43(10), 782.
- Sobral, P., & Widdows, J. (1997). Effects of copper exposure on the scope for growth of the clam *Ruditapes decussatus* from southern Portugal. *Marine pollution bulletin*, 34(12), 992–1000.
- Sunila, I. (1988). Acute histological responses of the gill of the mussel, *Mytilus edulis*, to exposure by environmental pollutants. *Journal of Invertebrate Pathology* 52, 137–141.

Tabrez, S., Ahmad, M. (2012). Cytochrome P450 system as potential biomarkers of certain toxicants: comparison between plant and animal models. *Environ Monit Assess.* 185(4), 2977–2987.

Ten Hallers-Tjabbes, C.C., Kemp, J.F., & Boon, J.P. (1994). Imposex in whelks (*Buccinum undatum*) from the open North Sea: Relation to shipping traffic intensities. *Marine Pollution Bulletin*, 28(5), 311–313.

Tomanek, L. (2011). Environmental proteomics: changes in the proteome of marine organisms in response to environmental stress, pollutants, infection, symbiosis, and development. *Annual Review of Marine Science*, 3, 373–399.

Urlacher, V.B., Girhard, M. (2012). Cytochrome P450 monooxygenases: an update on perspectives for synthetic application. *Trends in Biotechnology* 30, 26–36.

Verslycke, T., Roast, S D., Widdows, J., Jones, M.B., & Janssen, C.R. (2004). Cellular energy allocation and scope for growth in the estuarine mysid *Neomysis integer* (Crustacea: Mysidacea) following chlorpyrifos exposure: a method comparison. *Journal of Experimental Marine Biology and Ecology*, 306(1), 1–16.

Von Westernhagen, H., Dethlefsen, V., Cameron, P., & Janssen, D. (1987). Chlorinated hydrocarbon residues in gonads of marine fish and effects on reproduction. *Sarsia*, 72(3–4), 419–422.

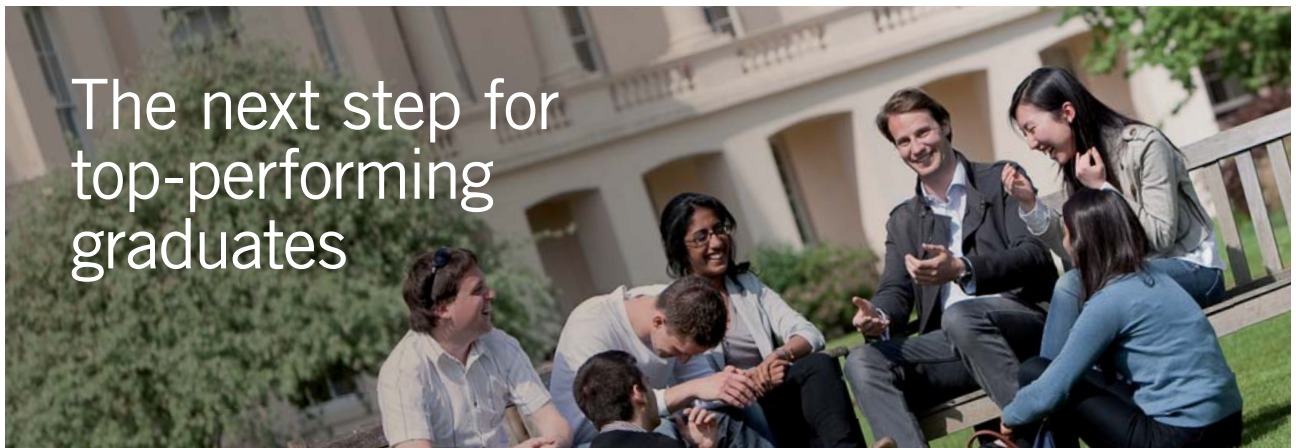

Masters in Management



Designed for high-achieving graduates across all disciplines, London Business School's Masters in Management provides specific and tangible foundations for a successful career in business.

This 12-month, full-time programme is a business qualification with impact. In 2010, our MiM employment rate was 95% within 3 months of graduation*; the majority of graduates choosing to work in consulting or financial services.

As well as a renowned qualification from a world-class business school, you also gain access to the School's network of more than 34,000 global alumni – a community that offers support and opportunities throughout your career.

For more information visit www.london.edu/mm, email mim@london.edu or give us a call on +44 (0)20 7000 7573.

* Figures taken from London Business School's Masters in Management 2010 employment report



- Von Westernhagen, H., Rosenthal, H., Dethlefsen, V., Ernst, W., Harms, U., & Hansen, P.D. (1981). Bioaccumulating substances and reproductive success in baltic flounder *Platichthys flesus*. *Aquatic Toxicology*, 1(2), 85–99.
- Webber, H.M., Haines, T.A. (2003). Mercury effects on predator avoidance behaviour of a forage fish, golden shiner (*Notemigonus crysoleucas*). *Environmental Toxicology and Chemistry*, 22(7), 1556–1561.
- Weis, P., & Weis, J.S. (1974). Schooling behavior of *Menidia menidia* in the presence of the insecticide Sevin (carbaryl). *Marine biology*, 28(4), 261–263.
- Weis, P., & Weis, J.S. (1974). DDT causes changes in activity and schooling behavior in goldfish. *Environmental Research*, 7(1), 68–74.
- Whittaker, R.H. (1972). Evolution and measurement of species diversity. *Taxon* 21, 213–251.
- Widdows, J., & Donkin, P. (1991). Role of physiological energetics in ecotoxicology. *Comparative Biochemistry and Physiology Part C: Comparative Pharmacology*, 100(1), 69–75.
- Widdows, J., & Shick, J.M. (1985). Physiological responses of *Mytilus edulis* and *Cardium edule* to aerial exposure. *Marine Biology*, 85(3), 217–232.
- Widdows, J., Burns, K.A., Menon, N.R., Page, D.S., & Soria, S. (1990). Measurement of physiological energetics (scope for growth) and chemical contaminants in mussels (*Arca zebra*) transplanted along a contamination gradient in Bermuda. *Journal of Experimental Marine Biology and Ecology*, 138(1), 99–117.
- Widdows, J., Nasci, C., & Fossato, V.U. (1997). Effects of pollution on the scope for growth of mussels (*Mytilus galloprovincialis*) from the Venice Lagoon, Italy. *Marine Environmental Research*, 43(1), 69–79.
- Wo, K.T., Lam, P. K., & Wu, R.S. (1999). A Comparison of Growth Biomarkers for Assessing Sublethal Effects of Cadmium on a Marine Gastropod, *Nassarius festivus*. *Marine Pollution Bulletin*, 39(1), 165–173.
- Young, J.S., & Pearce, J.B. (1975). Shell disease in crabs and lobsters from New York Bight. *Marine Pollution Bulletin*, 6(7), 101–105.
- Zbinden, G., Flury-Roversi, M. (1981). Significance of the LD50 test for the toxicological evaluation of chemical substances. *Archives of Toxicology* 47, 77–99.

2.9.2 Websites

IMO (2002) Anti-fouling systems. <http://www.imo.org/OurWork/Environment/Anti-foulingSystems/Documents/FOULING2003.pdf>. Checked on 22 December 2012.



Get Internationally Connected at the University of Surrey

MA Intercultural Communication with International Business
MA Communication and International Marketing



MA Intercultural Communication with International Business

Provides you with a critical understanding of communication in contemporary socio-cultural contexts by combining linguistic, cultural/media studies and international business and will prepare you for a wide range of careers.

MA Communication and International Marketing

Equips you with a detailed understanding of communication in contemporary international marketing contexts to enable you to address the market needs of the international business environment.

For further information contact:

T: +44 (0)1483 681681

E: pg-enquiries@surrey.ac.uk

www.surrey.ac.uk/downloads



Click on the ad to read more

3 Inorganic pollutants

While chapter 2 gave a full overview of the different ways a pollutant (in general) affects an organism, this and the next chapters present the most important classes of pollutants in more detail: their mode of action, their specific consequences, and examples to illustrate all of this. In this chapter, the inorganic components are treated: inorganic nutritive ions like phosphates and nitrates, gases like carbon dioxide and metals. Organic pollutants are the focus of chapter 4, and chapter 5 deals with less classic types of pollution, such as plastics and noise.

3.1 Inorganic nutrients and eutrophication

The first group of pollutants to be discussed are ammonia (NH_4^+), nitrate (NO_3^-) and phosphate (PO_4^{3-}). In many situations, they would not be considered to be pollutants. All of these inorganic ions are essential for obtaining healthy, well growing crops. They are therefore the constituents of artificial fertilisers. Nevertheless, when these ions occur in higher concentrations, they are quite capable of destroying the normal ecological harmony.

3.1.1 Essential components for plant growth

To start this part, we will first sketch on the nitrogen cycle on land (based on Figure 3-1). In the next paragraph, we can then compare the terrestrial cycle with the more complicated marine cycle.

Nitrogen is needed mainly for the synthesis of amino acids (for the production of proteins) and nucleotides (for the production of DNA and RNA). It is a very abundant element on earth, given that the atmosphere consists for around 78% of nitrogen gas (N_2). However, due to the fact that in this molecule both nitrogen atoms are linked to each other by way of a triple covalent bond, which is nearly unbreakable for most organisms, nitrogen gas may be abundant, but remains biologically inert. However, there are a number of bacteria (and only bacteria) that are capable of converting the inert nitrogen gas into a component that can be taken up and used by plants. As such, nitrogen becomes available for the organisms on Earth. In this process, called nitrogen fixation, N_2 is reduced to ammonia (NH_4^+). Organisms responsible for this process are for example the rhizobia in the root nodules of Fabaceae, the actinomycete *Frankia* (often in symbiosis with alder trees) or a number of cyanobacteria, which may be free-living, or in association with coral reefs. In the case of the latter, forming such a symbiosis is apparently very efficient, as these cyanobacteria are able to fix twice the amount of nitrogen than on land: around $1.8 \text{ kg of N ha}^{-1} \text{ day}^{-1}$.

Ammonia can also arise from the degradation of the dead remainders of animals and plants, by bacteria or fungi. This process is called **ammonification**. Further oxidation of the ammonia, by a number of free living soil bacteria such as *Nitrosomonas* sp., leads to the formation of nitrite (NO_2^-). This rather toxic component is further metabolised to nitrate by other species, such as *Nitrobacter*. The formation of nitrite and nitrate is called **nitrification**.

Together, ammonia and nitrate are the primary forms of nitrogen in solution. Generally, plants adapted to soils with a low pH and a low oxygen content (e.g. mature forests or arctic tundra) prefer ammonium as their nitrogen source, whereas plants from soils with a higher pH and more aerobic conditions rather take up nitrate (Maathuis 2009). The latter reduce the nitrate to ammonia after uptake. Ammonia is then used for the synthesis of amino acids by way of a transamination reaction (Figure 3-2), which are in turn used for protein synthesis. This is reviewed further by Masclaux-Daubresse et al. (2010).

Finally, there are bacteria that transform nitrate ions back into nitrogen gas. This is **denitrification**.

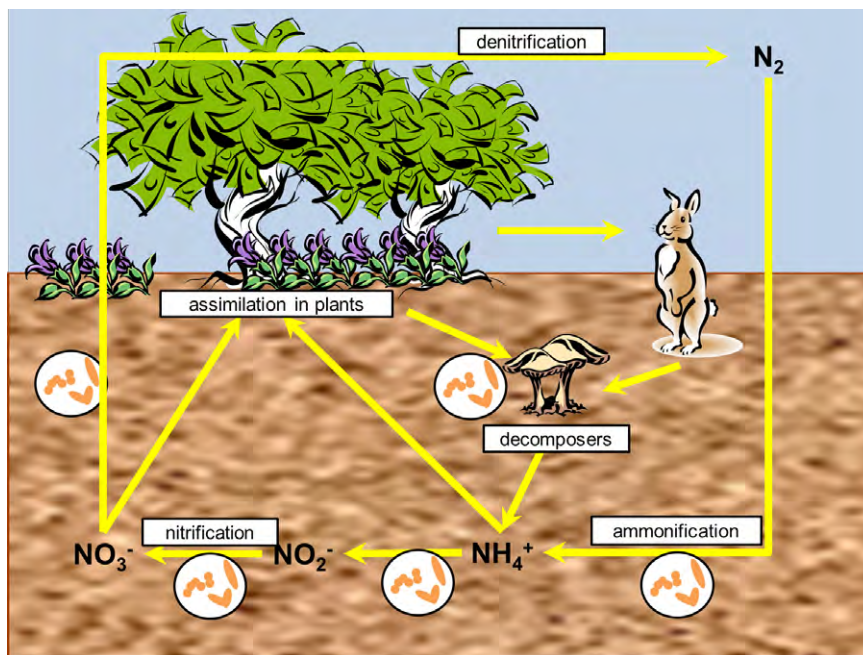

Figure 3-1. The terrestrial nitrogen cycle.

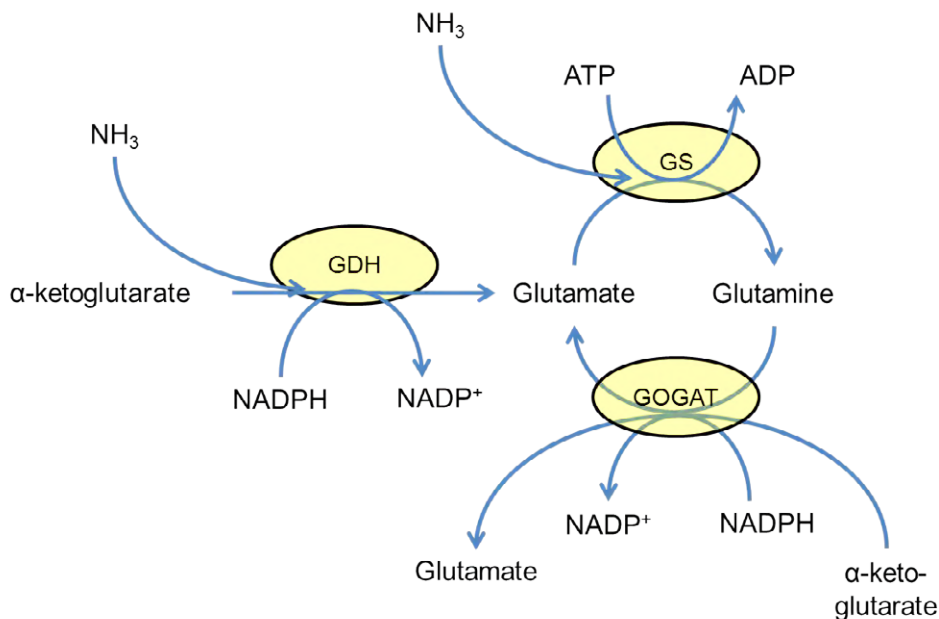

Figure 3-2. Nitrogen assimilation. The transamination reaction between ammonia and α -ketoglutarate leads to the amino acid glutamate; further transamination leads to glutamine. GDH: glutamate dehydrogenase; GS: glutamine synthase; GOGAT: glutamine:2-oxoglutarate aminotransferase.

Form	Function	Where to find ?
Nitrate (NO ₃ ⁻)	<ul style="list-style-type: none"> - Nitrogen source, - Electron acceptor for anaerobe bacteria 	<ul style="list-style-type: none"> - Coastal upwelling zones - Deep ocean
Ammonium (NH ₄ ⁺)	<ul style="list-style-type: none"> - Nitrogen source - Energy source - Electron donor 	<ul style="list-style-type: none"> - Rapidly recycled pool in open ocean
Nitrite (NO ₂ ⁻)	<ul style="list-style-type: none"> - Nitrogen source - Energy source - Electron donor and acceptor 	<ul style="list-style-type: none"> - At margins of oxic/anoxic zones
Dinitrogen (N ₂)	<ul style="list-style-type: none"> - Nitrogen source for assimilation from atmosphere 	<ul style="list-style-type: none"> - Atmosphere
Nitrous oxide (N ₂ O)	<ul style="list-style-type: none"> - Electron donor and acceptor 	<ul style="list-style-type: none"> - Intermediate in nitrification - At oxic/anoxic interface - In anoxic/suboxic zones
Organic nitrogen	<ul style="list-style-type: none"> - Nitrogen source 	<ul style="list-style-type: none"> - Complex organic matter is found throughout oceans
Urea [(NH ₂) ₂ -C=O]	<ul style="list-style-type: none"> - Nitrogen source 	<ul style="list-style-type: none"> - Decomposition product, in water column

Table 3-1. Major forms of nitrogen in the ocean After Zehr and Kudela (2011).

3.1.2 The nitrogen cycle in the marine environment

For organisms in a marine environment, nitrogen is even more precious than for those on land. A lack of nitrogen is generally speaking one of the major limitations for net primary production by the phytoplankton, the basis of all marine food chains and webs.

The overall nitrogen cycle in marine ecosystems is similar to the terrestrial one. In a first step, nitrogen is fixed into a biologically useful form (ammonia), mainly by cyanobacteria. Other ways by which nitrogen enters the seas and the oceans are runoff from the land and precipitation (e.g., in the guise of acid rain). However, without extra fixation, the oceans would be devoid of nitrogen in about 2000 years (Gruber 2008). The contribution of these cyanobacteria is therefore crucial.

Only a handful of cyanobacteria, such as *Trichodesmium* sp., are able to **fix nitrogen** gas. Some of them are free-living, and occur in oligotrophic waters, where they are able to alleviate the lack of bio-available nitrogen, but are still dependent upon a decent influx of phosphates. Nitrogen fixation also takes place in shallow and oligotrophic waters harbouring coral reefs – more specifically, in the cyanobacteria that live as symbionts in the corals and sponges that make up these reefs. Other cyanobacteria, like *Richelia* sp. (Figure 3-3) form symbioses with microalgae (diatoms) or macroalgae, or with higher plants (such as the saltmarsh grass *Spartina* spp.).

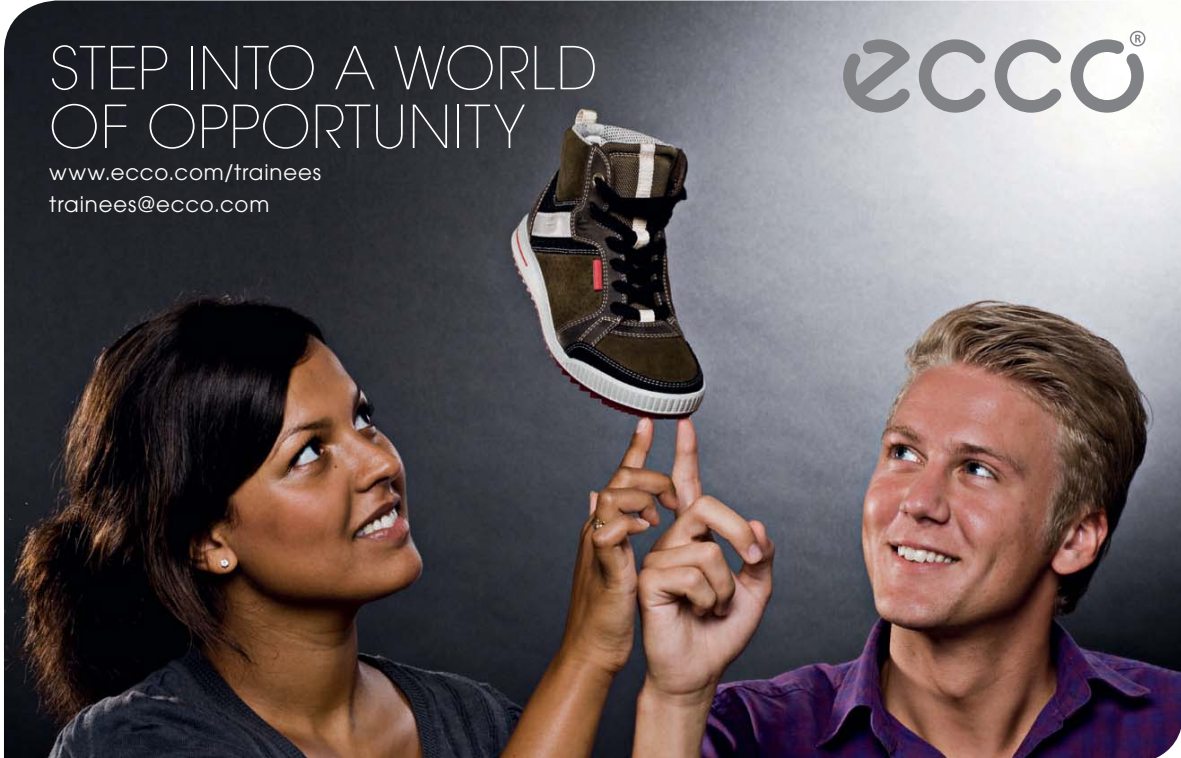

STEP INTO A WORLD
OF OPPORTUNITY

www.ecco.com/trainees
trainees@ecco.com

eCCO[®]

The advertisement shows a woman on the left and a man on the right, both smiling and looking upwards. They are holding a brown and white ECCO sneaker between their fingers. The background is a dark, textured grey.



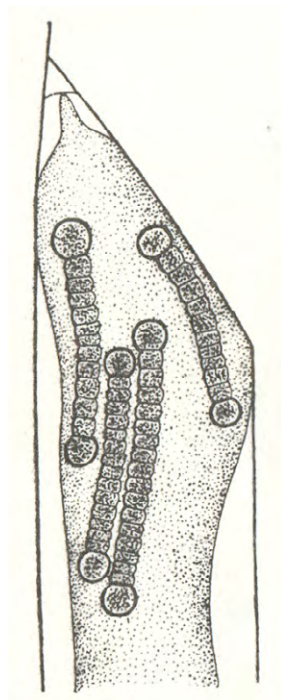

Figure 3-3. Endophytic form of the cyanobacterium *Richelia intracellularis*. Original drawing from Schmidt in 1901. Found at <http://www.cyanodb.cz/Richelia>

The cyanobacteria (as well as the planktonic organisms that graze on them) release the fixed nitrogen as ammonia into the water. NH_4^+ is further oxidised by a number of bacterial species in a **nitrification**⁵ step to form nitrate, which is the preferential source of fixed nitrogen for phytoplankton. Once taken up, this nitrate is further reduced intracellularly by a nitrate reductase (to NO_2^-) and a nitrite reductase (to NH_4^+), since ammonia is the preferential form for assimilation of the nitrogen into the cell metabolism. This ammonia is then built into amino acids by way of a transamination reaction (Figure 3-2).

A factor to be reckoned with in marine ecology is the so-called biological pump (Figure 3-6). This pump forms the bridge between the euphotic zone (the zone where sunlight can still penetrate the water and where it is used by the autotrophic organisms) and the deeper layers of the ocean. In the euphotic zone, atmospheric CO_2 and N_2 gas are fixed into organic molecules.

Due to the existence of the biological pump, this newly formed organic material is transported to the lower zones, where it serves as a basis for the food chain below.

This transport occurs in various ways.

1. Phytoplankton dies off and sinks; herbivores digest the phytoplankton they ate and produce sinking faecal pellets. This organic material may then be consumed and decomposed by the organisms in the deeper zones.
2. Also, some zooplankton species feed in the surface waters at night and return to the deeper layers during the day, where they digest the ingested food.
3. Dissolved organic carbon produced by phytoplankton or by animal excretion in surface waters can be transported downward during deep mixing events.
4. Together with the organic material, some calcite and aragonite will sink as well. These calcium carbonate minerals are inorganic in nature, but organic in origin (as they make up the shells of crustaceans and molluscs).

The sinking results in ammonia being introduced at lower depths. The bacteria at these depths will assist in the nitrification (conversion of ammonia to nitrite and nitrate). The resulting nitrate can then return to the euphotic zone by vertical mixing and upwelling. Different microbes are responsible for each of the steps in the oxidation of ammonia, such as *Nitrosomonas*, *Nitrospira*, and *Nitrosococcus*.

Finally, there is the process called **anammox** (short for anaerobic ammonium oxidation). This process transforms fixed nitrogen (in the form of ammonia and nitrite) back to N_2 gas, thereby closing the nitrogen cycle:

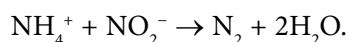

About 50% of the N_2 gas that is being produced in the oceans, comes out of the anammox process, which thereby acts as a sink for fixed nitrogen, and limits the general productivity of the oceans. The organisms that are responsible for this step in the nitrogen cycle all belong to the bacterial phylum of the Planctomycetes. In fresh water, four genera have been found to contribute to anammox so far (*Brocadia*, *Kuenenia*, *Anammoxoglobus*, *Jettenia*), while scientists have identified only one bacterial genus in marine ecosystems (*Scalindua*).

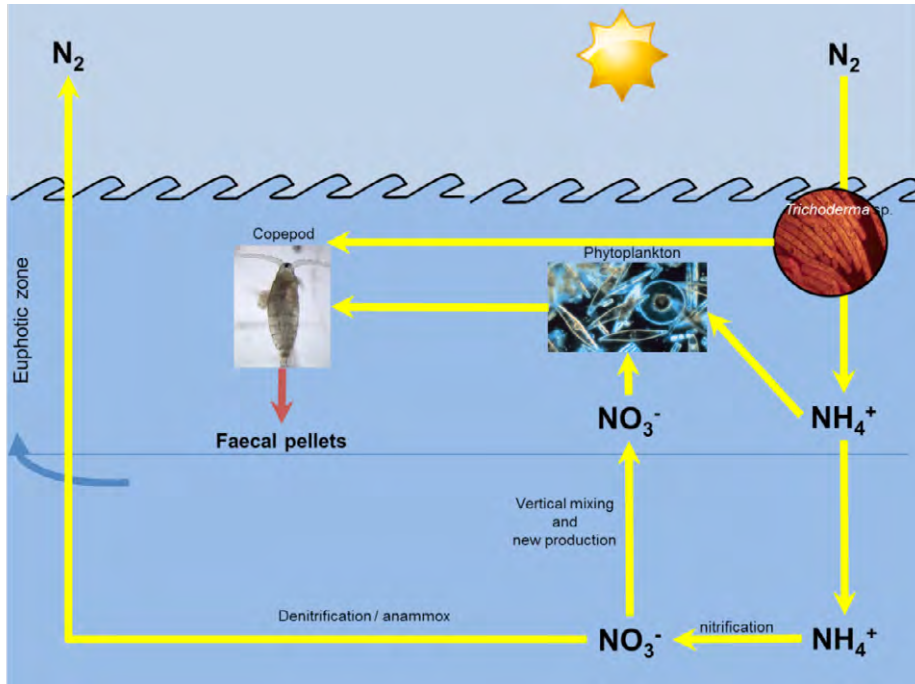

Figure 3-4. The marine nitrogen cycle.

efficiency reliability delivery

As a leading technology company in the field of geophysical science, PGS can offer exciting opportunities in offshore seismic exploration.

We are looking for new BSc, MSc and PhD graduates with Geoscience, engineering and other numerate backgrounds to join us.

To learn more our career opportunities, please visit www.pgs.com/careers

A Clearer Image
www.pgs.com



Click on the ad to read more

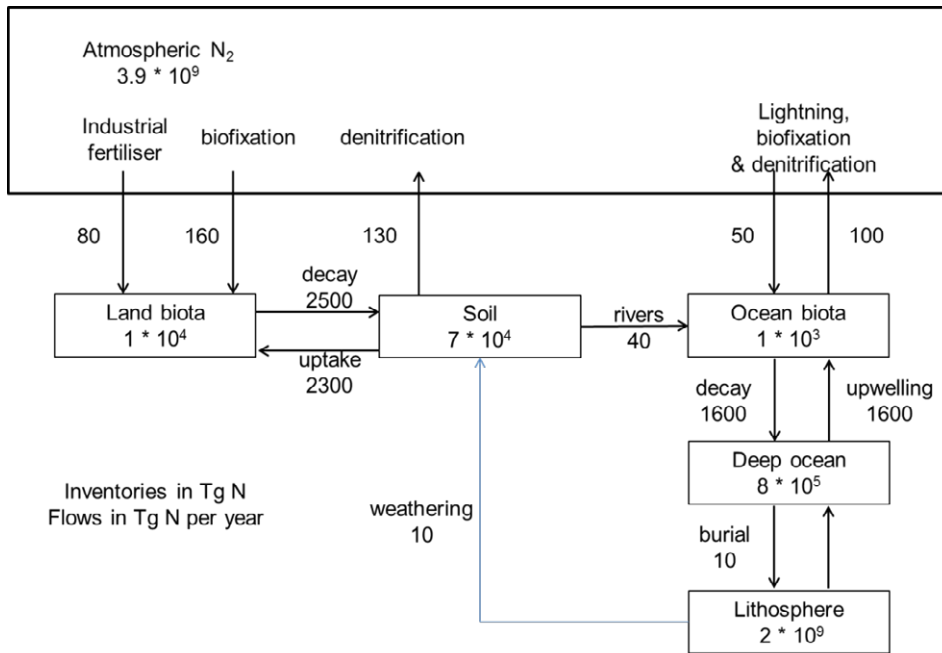

Figure 3-5. Quantification of nitrogen fluxes between different compartments of the earth's ecosystem.

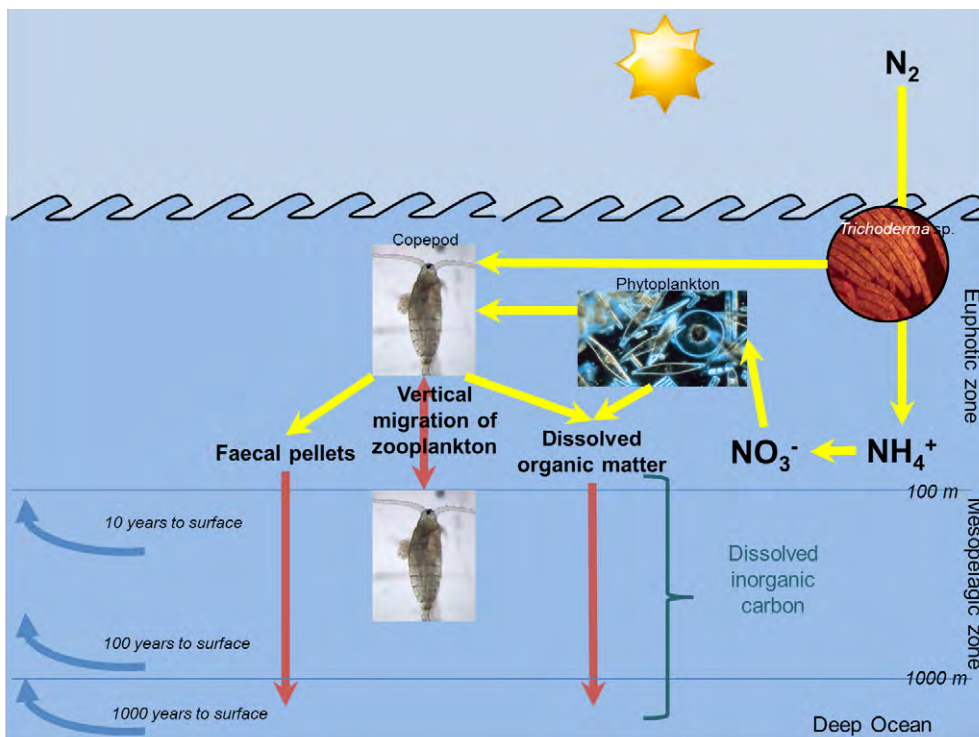

Figure 3-6. Schematic of the biological pump.

Organic matter formed within the euphotic zone is transported to depth by (1) vertical migrating zooplankton (symbolised by a copepod), (2) gravitational settling of dissolved organic matter and faecal pellets. The average time until the dissolved inorganic carbon and nutrients are returned back to the surface depends on the depth of remineralisation.

3.1.3 A high influx of nutrients damages the aquatic ecosystem: eutrophication

There is no doubt that such excess levels of nitrogen and phosphates strongly affect life in aquatic ecosystems. A high concentration of ammonia can be toxic for the fish populations. And whenever a water body (lake, river, sea or ocean) receives an input of nitrate-enriched water, it becomes subject to eutrophication.

Eutrophication is “the process by which a body of water acquires a high concentration of nutrients, especially phosphates and nitrates. These typically promote excessive growth of algae, especially cyanobacteria. As the algae die and decompose, high levels of organic matter and the decomposing organisms deplete the water of available oxygen, causing the death of other organisms, such as fish” (Art, 1993).

Eutrophication is in essence due to the competition between the autotrophic and heterotrophic organisms in the ecosystem.

- “Autotrophic” organisms are literally “feeding by themselves”, from the Greek words autos and trofein. These are creatures like plants, algae and cyanobacteria who use carbon dioxide as a carbon source and the energy from sunlight to synthesize their own foodstuff: carbohydrate molecules that form the basis of the rest of their metabolism and growth, or that are stored as reserve material. Other bacteria convert carbon dioxide into carbohydrates using the energy they obtained from the oxidation of sulfur- and nitrogen-containing ions.
- “Heterotrophic” organisms use others (heteros, in Greek) as a source of food. These organisms (fungi, animals, again many bacteria) break down the larger macromolecules (DNA, proteins, reserve material) once produced by other organisms. This breakdown gives them enough energy to maintain their active metabolism, as well as different biochemical molecules for further catabolism. Ultimately, the macromolecules are transformed into simple inorganic ions and molecules, which then serve as resources, for example for the autotrophs.

Under normal circumstances, autotrophy and heterotrophy are keeping each other in check.

However, nowadays excessive amounts of nitrogen and phosphates end up in the water due to run-off from the land, sewage water and waste material being dumped. At the same time, these elements are normally limiting primary production in an aquatic ecosystem (and certainly in a marine one). An enormous influx of N and P will therefore act as a stimulus for an increased production of algal biomass. This is the so-called algal bloom. However, this biomass production proceeds to such an extent that the layer of algae becomes so thick, that the lower part is deprived of sunlight, stops photosynthesizing and dies off. At that moment, heterotrophic bacteria will start to degrade the dead biomatter, consuming nearly all oxygen that is dissolved in the water in the process. That way, too little oxygen remains for the animals (invertebrates such as molluscs, worms and crustaceans, but also the fish) in the ecosystem, which then, too, start to die (Figure 3-7).

Examples of eutrophication, made visible by the algal bloom, can be seen in Figure 3-8, Figure 3-9 and Figure 3-11.

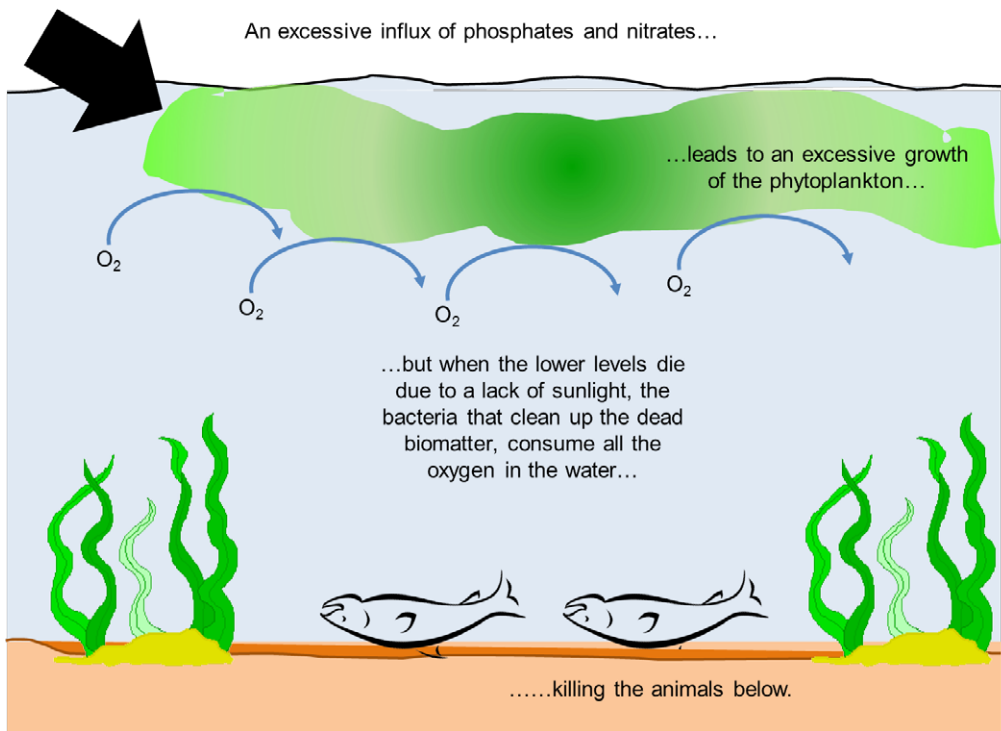

Figure 3-7. The process of eutrophication

STUDY.
The stuff you'll need to make a good living

The advertisement features a tall stack of various books on a wooden desk. In the background, there are bookshelves filled with more books, creating a library-like atmosphere.

PLAY.
The stuff that makes life worth living

NORWAY.
YOUR IDEAL STUDY DESTINATION.

WWW.STUDYINNORWAY.NO
FACEBOOK.COM/STUDYINNORWAY

LOOK UP
STUDY IN NORWAY.

The advertisement shows a snowboarder in mid-air, performing a trick over a snowy slope. The snowboarder is wearing a dark jacket and yellow pants. The background is a bright, snowy landscape.





Figure 3-8. Red tide at of La Jolla San Diego, California.

Source: Alejandro Díaz, Wikipedia

Moreover, the algal bloom (or red tide, Figure 3-8) itself may cause additional problems for the health of marine organisms (or for tourists who wish to enjoy a swim in the ocean). About 2% of the marine microalgae are known to produce toxic compounds, which are known to harm other organisms, like sea mammals and sea reptiles. One such example is the neurotoxic compound brevetoxin, produced by the dinoflagellate *Karenia brevis* (Figure 3-10). A bloom of this organism in 2004 along the coast of Florida caused the death of large numbers of fish, and even, though indirectly, a number of dolphins and manatees (Flewelling et al. 2005). The latter victims are due to the fact that the toxin is often accumulated and magnified in the food chain, a process which increases the danger for the animals on the upper trophic levels (Bricelj et al. 2012).

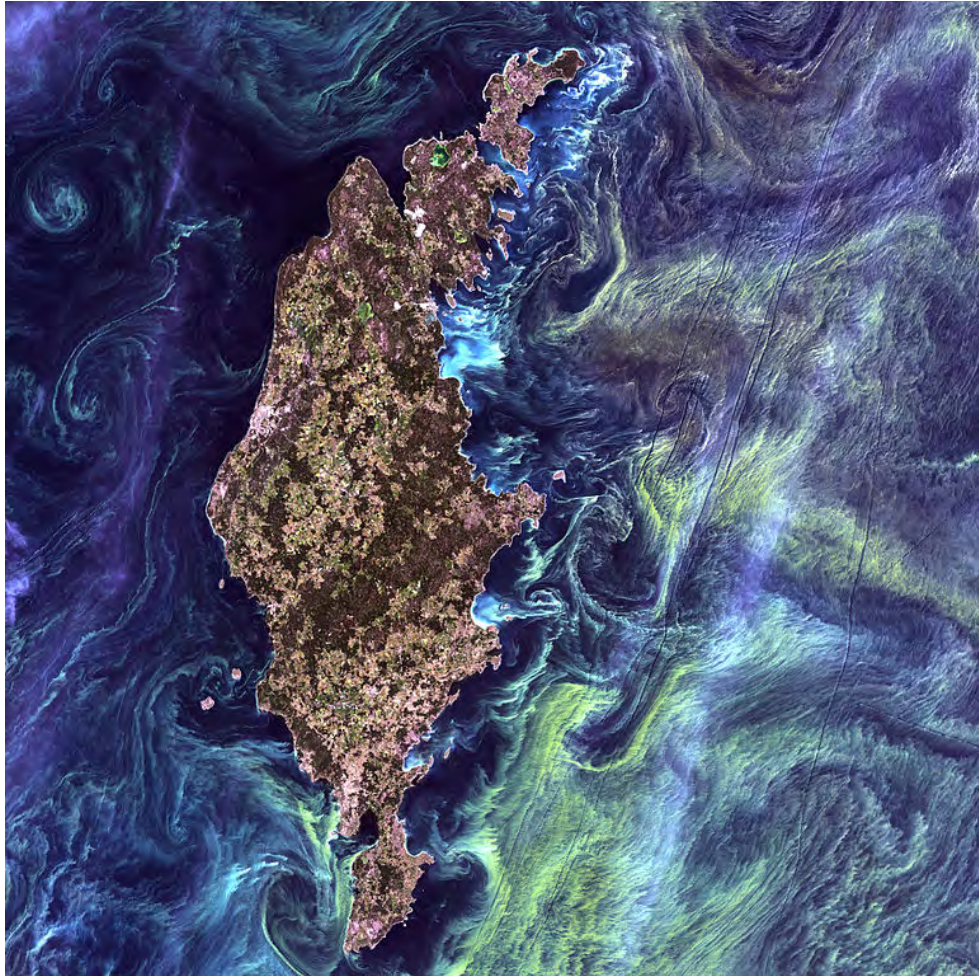

Figure 3-9. Algal bloom around the island of Goteborg, Sweden.
Credit: USGS/NASA/Landsat 7

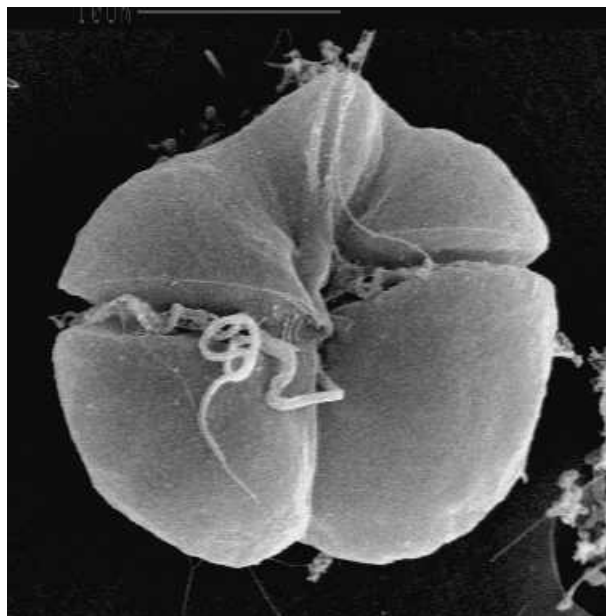

Figure 3-10. *Karenia brevis*, a dinoflagellate that causes harmful algal blooms.
Source: Florida Fish and Wildlife Conservation Commission



Figure 3-11. Eutrophication in the Sea of Azov
 Source: SeaWiFS Project, NASA/Goddard Space Flight Center, and ORBIMAGE. See also Visible Earth, Nasa, at <http://visibleearth.nasa.gov/view.php?id=54054>



Technical training on *WHAT* you need, *WHEN* you need it

At IDC Technologies we can tailor our technical and engineering training workshops to suit your needs. We have extensive experience in training technical and engineering staff and have trained people in organisations such as General Motors, Shell, Siemens, BHP and Honeywell to name a few.

Our onsite training is cost effective, convenient and completely customisable to the technical and engineering areas you want covered. Our workshops are all comprehensive hands-on learning experiences with ample time given to practical sessions and demonstrations. We communicate well to ensure that workshop content and timing match the knowledge, skills, and abilities of the participants.

We run onsite training all year round and hold the workshops on your premises or a venue of your choice for your convenience.

For a no obligation proposal, contact us today at training@idc-online.com or visit our website for more information: www.idc-online.com/onsite/

**OIL & GAS
ENGINEERING**

ELECTRONICS

**AUTOMATION &
PROCESS CONTROL**

**MECHANICAL
ENGINEERING**

**INDUSTRIAL
DATA COMMS**

**ELECTRICAL
POWER**

Phone: **+61 8 9321 1702**
 Email: **training@idc-online.com**
 Website: **www.idc-online.com**





3.1.4 The cost of eutrophication

The process is not only a threat for the viability of many ecosystems, but also constitutes a drain on financial resources. For example, eutrophic water bodies no longer contribute to the production of drinking water. In other instances, algae overrun touristic zones. Elsewhere, expensive measures are required to protect endangered species. All in all, losses due to eutrophication are estimated at around 2.2 billion dollar per year (1.7 billion EUR), in the fresh water ecosystems of the United States alone (data from Dodds et al. 2009).

A study on the health of the kelp (*Saccharina latissima*) forests along the Norwegian shores, performed between 1996 and 2006, indicated a loss of 40% of the normal biomass along the west coast of the country, and even up to 80% along the Skagerrak. This alarming decline was the consequence of an invasion of filamentous epiphytic algae, which completely overrun the existing flora (Sogn Andersen et al. 2011). The decline of these kelp forests lead to the loss of around 50 000 tonnes of fish stocks, and deprived Norway of the possibility to fix carbon dioxide in a growing kelp forest, for a total worth of around 11 million EUR.

3.2 Carbon dioxide and ocean acidification

A second type of inorganic pollution of the oceans forms the link between the chemistry of the atmosphere and of the ocean. Overall, there are three ways in which the gases in the atmosphere can affect life in the oceans.

First, there is the process of **global warming**, driven by the on-going accumulation of greenhouse gases (CO_2 , CH_4 , N_2O , Chlorofluorocarbons and SF_6) in the atmosphere. As this topic would require a more detailed treatment than is possible here, we refer to the chapters 9 and 10 in the book “Atmospheric Pollution” by J.C. Jones, as well as the book “A Wet Look at Climate Change” by P. Moir, both available at bookboon.com.

Secondly, there is the phenomenon of **acid rain**. Briefly – the quantities of SO_2 or NO_x that are emitted on Earth will react in the atmosphere with hydroxyl radicals and oxygen to form sulfuric acid and nitric acid (dissolved in the atmospheric water vapour), as follows:

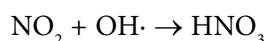
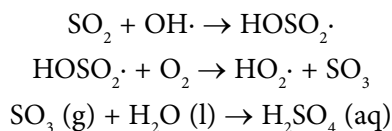

When it rains, the water takes the acid with it, so that it enters the biosphere on Earth. Typical effects comprise the damage seen in forests (*Waldsterben*), acidification of lakes and rivers and the concomitant disturbance of the communities there, and damage to limestone and marble monuments. Nevertheless, while acid rain may well affect shallow coastal waters and freshwater ecosystems, there is little evidence that claims that acid rain has a substantial effect on life in the oceans. It will not be discussed further here; again, we refer to chapters 9 and 10 of the e-book of J.C. Jones for a more in-depth treatment of the phenomenon.

Lastly, there exists an equilibrium between the carbon dioxide in gaseous form in the atmosphere and the one in aqueous solution in the oceans. When CO_2 goes in solution, it forms carbonic acid, which then in turn dissociates into protons and carbonate ions.

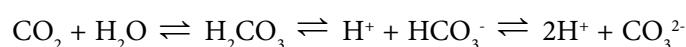

The more CO_2 is present in the atmosphere, the more will dissolve in the oceans and dissociate, causing an increase in the amount of protons present, hence in the acidity, and a decrease in the pH. This slow but noticeable process (Table 3-2) is known as the **acidification of the oceans**. A simulation of the process of ocean acidification can be found at: <http://www.dataintheclassroom.org/content/oa/> (link checked August 13, 2013).

Moment in time	pH	pH change	Source
Pre-industrial (1750)	8.179	0.000	measurements
± Millennium change (1994)	8.104	-0.075	measurements
2050 ($2 \times [\text{CO}_2] = 560$ ppm)	7.949	-0.230	modelling
2100 ($[\text{CO}_2]$ according to some IPCC predictions)	7.824	-0.355	modelling

Table 3-2. pH changes since the Industrial Revolution.



Figure 3-12. Corals on the Great Barrier Reef near Cairns, Queensland, Australia.

Corals construct an exoskeleton that consists mainly of calcium carbonate. Acidification of the oceans may prevent them from doing so – which will lead to their extinction.

Source of the photo: Toby Hudson, on Wikipedia

www.studyat.tudelft.nl

- Ranked #15th in the world (THES Technology ranking 2009)
- Almost 170 years of problem solving experience
- Excellent Sports&Culture facilities
- Check out what and how we teach at www.ocw.tudelft.nl !

TU Delft Delft University of Technology

Challenge the future



Scientists predict that these changes in ocean pH will affect marine life forms, especially those such as molluscs and crustaceans, which depend upon a pH sensitive protection shell made out of calcium carbonate (Doney et al. 2009). Unfortunately, calcium carbonate dissolves on the influence of an increased acidity:

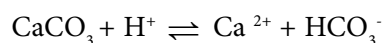

In oceans with rising concentrations of acid, that protective calcium-based shell or skeleton will be all the more difficult to produce. This makes that the effects of acidification are potentially far-reaching. All kinds of organisms which depend on the formation of calcium carbonate shells or skeletons may be in trouble, because carbonate formation in acidic water hampered. Including the phytoplankton, vital for a well-oiled carbon cycle and the basis for the whole food chain in the oceans. The calcareous skeleton of some important plankton species is now 30 to 35 percent thinner than before the Industrial Revolution. It is one of the first concrete evidence of the impact that ocean acidification has on marine life.

Consider for example the foraminifera. These unicellular creatures are very common in the world's oceans and play a role in the transport of a quarter to half of all carbon entering the oceans from the air to the deep sea – which in turn impacts significantly the amount of carbon dioxide in the atmosphere. The oceans absorb every day 30 million tonnes of CO_2 . If even part of that mechanism fails, the global climate itself is in serious problems. Or consider the many calcareous coral and many shellfish, such as oysters and mussels. Because many of these organisms occupy crucial positions down the food chain, any significant decrease in their population, let alone their extinction, would cause a massive loss of biodiversity.

Furthermore, as the ocean becomes enriched in anthropogenic CO_2 , the resulting decrease in pH could lead to decreasing rates of nitrification. Nitrification could potentially become a “bottleneck” in the nitrogen cycle.

It should be mentioned, however, that not all scientists are currently convinced that ocean acidification will have any severe consequence on marine ecosystems as we know them. According to their calculations, the current experiments have only subjected sea creatures to acute and direct changes in pH, instead of the slow changes that are going to happen (thereby failing to take into account that organisms are able to adapt); moreover, the changes in pH that were used in these experiments were too large to be realistic. This analysis can be found at (link checked January 7, 2013):

<http://www.co2science.org/data/acidification/acidification.php>

3.3 Metal pollution

3.3.1 Essential vs. non-essential metals

A third form of inorganic pollution consists of the presence of heavy metals in the environment. Heavy metals are in the strictest sense the ones that have a density higher than 5 g cm^{-3} . This is certainly true for the five main species – mercury, lead, cadmium, chromium and arsenic. However, lighter elements such as zinc and aluminium tend to affect living organisms as well, and it becomes increasingly clear these days that lighter metals are burdening the (marine) environment as strong as their heavier siblings. It is therefore not without reason that some scientists advise to speak only of “metal pollution”.

Metals are naturally present in the environment, albeit usually in their oxidised (cationic) form, for example in ores or in biological material. However, mankind has devised a great number of interesting applications for metals and alloys, enhancing the worldwide spread of metal pollution (even to those places that have never seen metal mining or processing). On top of that, metals are chemical elements, and they cannot be degraded (like sugars into CO_2 and H_2O), only cycled and recycled from organism to organism. As such, they are an excellent illustration of the law of conservation of misery⁶.

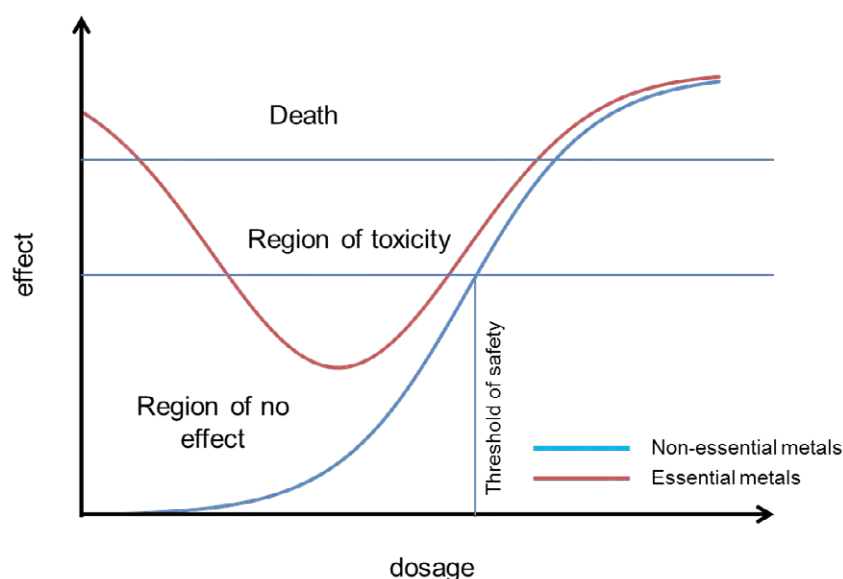

Figure 3-13. Dose-response curves for essential and non-essential metals.

Some metals (Zn, Cu, Cr, Se, Ni, Al) are necessary for a biological organism, and a minimal uptake is needed for a healthy life. They are the essential metals. Examples of such metals are listed in Table 3-3. Both overconsumption and metal shortage have deleterious effects on an organism (Figure 3-13).

Other metals (Hg, Cd, Pb) are non-essential: they constitute just a burden for the organism and have a deleterious effect upon its metabolism. As soon as their levels in the cells or organs of an organism surpass a critical threshold, the organism will suffer a number of symptoms, ultimately leading, at higher doses, to death (Figure 3-13). As such, this graph is essentially the same as the one in Figure 2-7.

Metal	Biological function
Potassium	Helps to preserve a proper electrochemical balance over the plasma membrane
Sodium	Helps to preserve a proper electrochemical balance over the plasma membrane
Calcium	Second messenger Needed in muscle functioning Needed in bone tissue synthesis
Magnesium	Cofactor in many ATPases Central ion in chlorophyll haem group
Zinc	Cofactor in many enzymes, e.g. carboxypeptidase, liver alcohol dehydrogenase, and carbonic anhydrase Part of zinc finger transcription factors
Iron	Central ion in haemoglobin haem group Cofactor in vitamin C uptake
Manganese	Cofactor in many enzymes
Copper	Cofactor in many redox-active enzymes, such as cytochrome c oxidase
Selenium	Cofactor essential to activity of antioxidant enzymes like glutathione peroxidase
Molybdenum	Cofactor in many enzymes, e.g. xanthine oxidase, aldehyde oxidase, and sulphite oxidase
Cobalt	Synthesis of vitamin B12 (by microbes)

Table 3-3. Essential metals for living organisms on Earth

“I studied English for 16 years but...
...I finally learned to speak it in just six lessons”
Jane, Chinese architect

ENGLISH OUT THERE

Click to hear me talking before and after my unique course download



Figure 3-14. Vegetation loss due to metal pollution in Siberia

“Norilsk, a major city in Krasnoyarsk Krai, Russia, and the northernmost city in Siberia, was founded in the 1930s as a settlement for the Norilsk mining-metallurgic complex, sitting near the largest nickel-copper-palladium deposits on Earth. Mining and smelting of nickel, copper, cobalt, platinum and palladium are the major industries. The smelting is directly responsible for severe pollution, generally acid rain and smog. By some estimates, 1 percent of the entire global emissions of sulfur dioxide comes from this one city. Heavy metal pollution near Norilsk is so severe that it is now economically feasible to mine the soil, which has been polluted so severely that it has economic grades of platinum and palladium.”

The image was acquired July 21, 2000 by ASTER on NASA's Terra satellite.

Image Credit: NASA/GSFC/METI/ERSDAC/JAROS, and U.S./Japan ASTER Science Team. Legend and image taken from: http://www.nasa.gov/multimedia/imagegallery/image_feature_1124.html

3.3.2 Sources of metals

There are three important sources for metal pollution on Earth:

Atmospheric metal pollution is accountable for the largest part of the input of Cd, Cu, Fe, Zn, Ni and As into the oceans. These metals originate from forest fires, volcanic activity, dust particles or anthropogenic emissions such as coal fired power stations and car exhausts. Metals can enter the atmosphere in solution in an aerosol drop (which may later evaporate and leave the metal particle floating in the air), or adsorbed to dust or particulate matter. Deposition from the atmosphere can occur via precipitation (wet deposition) or just as dry matter (dry deposition).

Rivers are the second way metals end up in the oceans. The metals then originate from the erosion of rocks containing metals or from runoff from a certain surface, dragging along metal particles which were deposited on that surface from the atmosphere. In the rivers, metals will often form different complexes (due to speciation) and precipitate to the sediments; however, these sediments can be uprooted when the river bed is dredged or trawled or when it is subjected to severe weather. However, the definition we developed in the first chapter is clear: since this is a completely natural process, this is not considered pollution (although the effects on the living organisms in the water may be equally severe).

Lastly, there are deliberate **human actions** which facilitate the entry of metals into rivers and oceans: the dumping of contaminated wastes, of sewage water or of industrial waste. All in all, anthropogenic emission is currently dwarfing natural emission sources (see Table 3-4), especially for Pb, Zn, Cd, Hg and Cu, and it does not seem that this is going to be remedied soon (Figure 3-15).

Metal	Natural sources	Anthropogenic sources
Arsenic	12	18
Cadmium	1.3	7.6
Copper	28	35
Lead	12	332
Nickel	30	56
Zinc	45	132

Table 3-4. Metal emissions into the atmosphere (in kiloton year⁻¹)
Data taken from Duce et al. (1991)

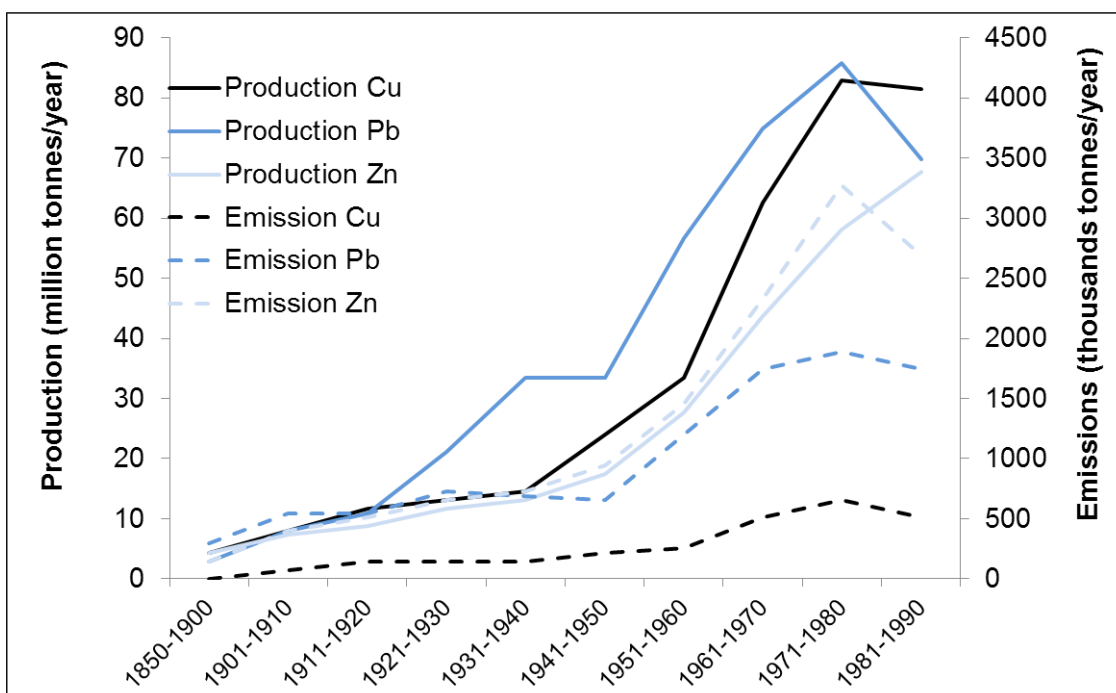

Figure 3-15. Global production and consumption of selected toxic metals, 1850–1990
Taken from Nriagu (1996) and Järup (2003).

Metals may be taken up by marine mammals via several different routes: uptake from the atmosphere via inhalation through the lungs, absorption through the skin or across the placenta before birth, via milk through lactating, ingestion of sea water and ingestion of food. The last one, however, is the most important (Figure 3-16).

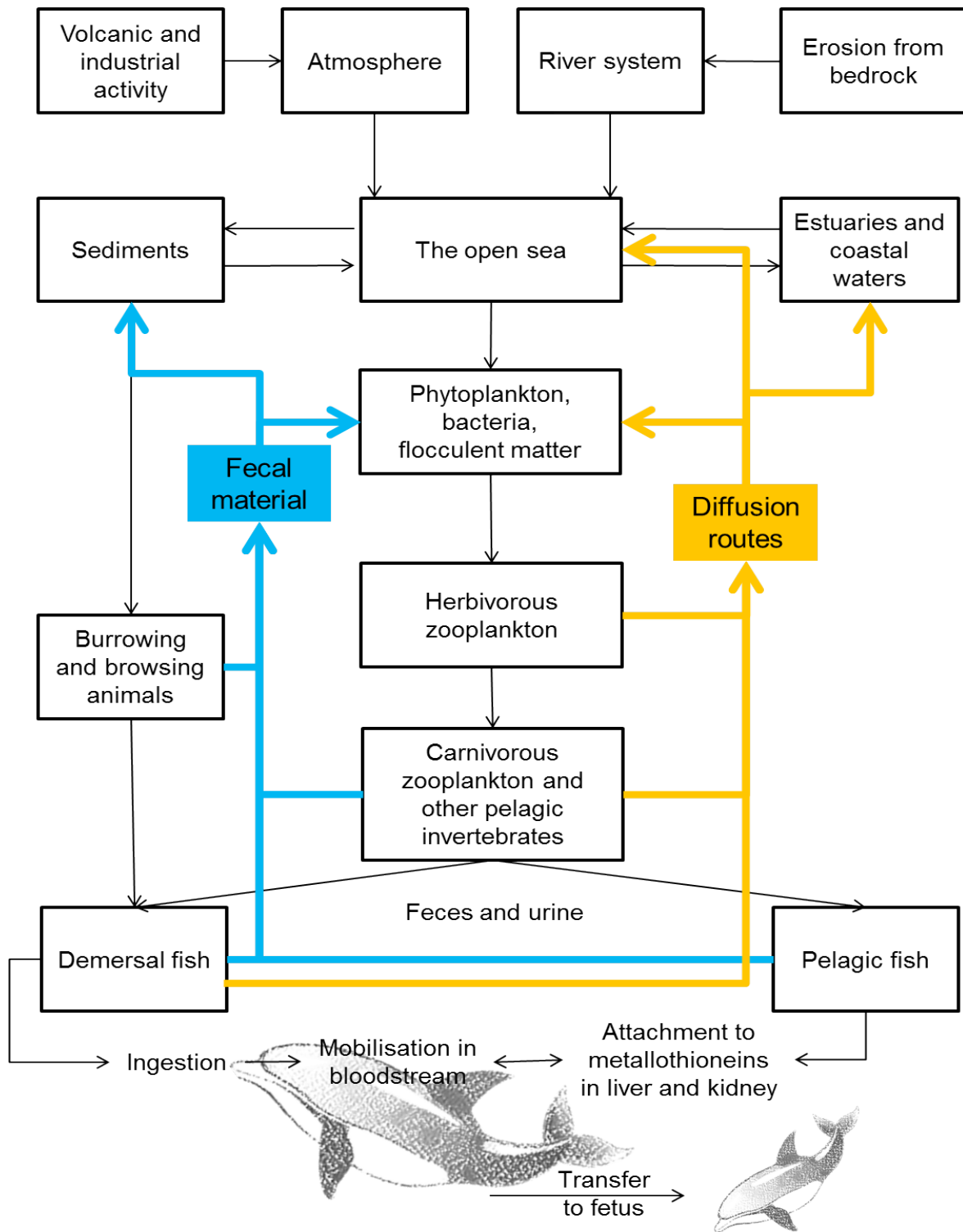

Figure 3-16. Pathway of metal contaminants in the food chain
After Gaskin (1982)

Metal	Minimum	Maximum
Hg	0.2 $\mu\text{g}\cdot\text{g}^{-1}$ muscle <i>Pusa hispida</i> Western Arctic Wagemann <i>et al.</i> , 1996	13156 $\mu\text{g}\cdot\text{g}^{-1}$ liver <i>Tursiops truncatus</i> Mediterranean Sea Leonzio <i>et al.</i> , 1992
Cd	0.007 muscle <i>Pusa hispida</i> (less than 1y. old) Northwest Greenland Dietz <i>et al.</i> , 1998	2324 $\mu\text{g}\cdot\text{g}^{-1}$ kidney <i>Pusa hispida</i> (8 y. old) Northwest Greenland Dietz <i>et al.</i> , 1998
Zn	2 $\mu\text{g}\cdot\text{g}^{-1}$ blubber (body fat) <i>Leptonychotes weddellii</i> (13 y.) Antarctic Yamamoto <i>et al.</i> , 1987	4183 $\mu\text{g}\cdot\text{g}^{-1}$ liver <i>Dugong dugon</i> (>30 y.) Australia Denton <i>et al.</i> , 1980
Cu	0.4 $\mu\text{g}\cdot\text{g}^{-1}$ blood <i>Leptonychotes weddellii</i> (13 y.) Antarctic Yamamoto <i>et al.</i> , 1987	600 $\mu\text{g}\cdot\text{g}^{-1}$ liver <i>Tursiops truncatus</i> Argentina Marcovecchio <i>et al.</i> , 1990

Table 3-5. Examples of smallest and largest concentrations of several non-essential metals found in marine mammals. Taken from Das *et al.* (2003)

All the data are expressed in $\mu\text{g}\cdot\text{g}^{-1}$ dry weight, assuming water content of 75% of the tissue

Study at one of Europe's leading universities



DTU, Technical University of Denmark, is ranked as one of the best technical universities in Europe, and offers internationally recognised Master of Science degrees in 39 English-taught programmes.

DTU offers a unique environment where students have hands-on access to cutting edge facilities and work

closely under the expert supervision of top international researchers.

DTU's central campus is located just north of Copenhagen and life at the University is engaging and vibrant. At DTU, we ensure that your goals and ambitions are met. Tuition is free for EU/EEA citizens.

Visit us at www.dtu.dk



Click on the ad to read more

3.3.3 Lead

Lead (Pb) is a typical example of anthropogenic metal pollution. It is a soft and malleable metal, with a bluish-white colour when freshly cut, which soon becomes grayish upon exposure to air. The metal is used in building construction, lead-acid batteries, bullets, weights, as part of solders, pewters, fusible alloys, and as a radiation shield. (Over)exposure to lead may lead to a number of health problems. The metal is able to damage the neural pathways and cause blood poisoning.

Some of the larger scale lead poisonings have taken place in Ancient times. In Roman times, lead was used as a lining for the water transport in the aqueducts, leading undoubtedly to higher concentrations in the drinking water than is healthy for a person. In addition, some sources claim that sour wine was often sweetened by adding defrutum – thickened must, boiled in lead lined kettles. Other authors question this theory by pointing out that the Romans knew about the dangers of lead⁷.

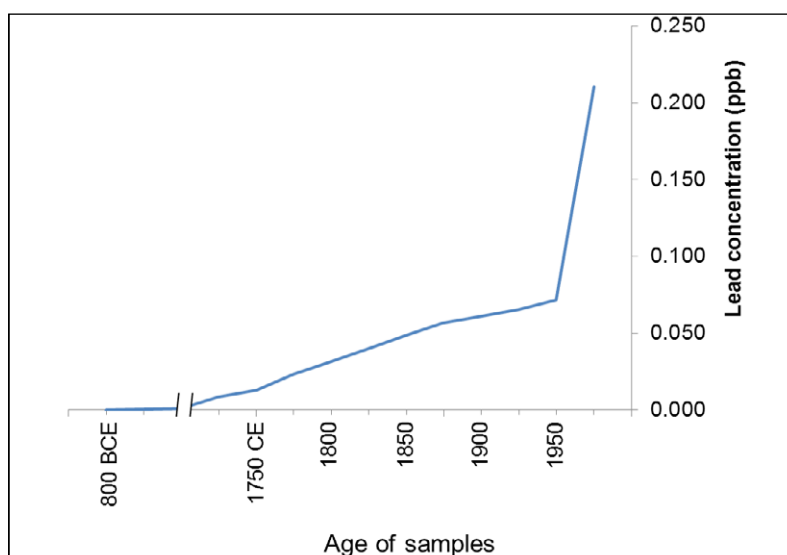

Figure 3-17. Lead contamination in Greenland snow cores.

The level of lead in the environment has gradually and slowly increased since mankind started to use the metal, in Roman times. Lead pollution has increased more rapidly since the start of the industrial revolution, and has risen exponentially due to the addition of lead to petrol (until at least the 1970s). Data from Murozumi et al. (1969)

Beginning with very low levels at about 2,700 years ago, Pb concentration increased during the industrial age and has risen rapidly since Pb was added to gasoline fuel of vehicles as anti-knocking agent. Pb levels were investigated in the ice cap of Greenland with the aid of ice core drillings. The lead concentrations in the ice were shown to have risen 200-fold from the natural level (Figure 3-17). When the lead in the gasoline was finally replaced by a more environment-friendly alternative, this caused a direct drop in Pb levels in human blood as well (Figure 3-18). It should be noted, however, that Pb pollution is more an issue in terrestrial ecosystems than in marine conditions.

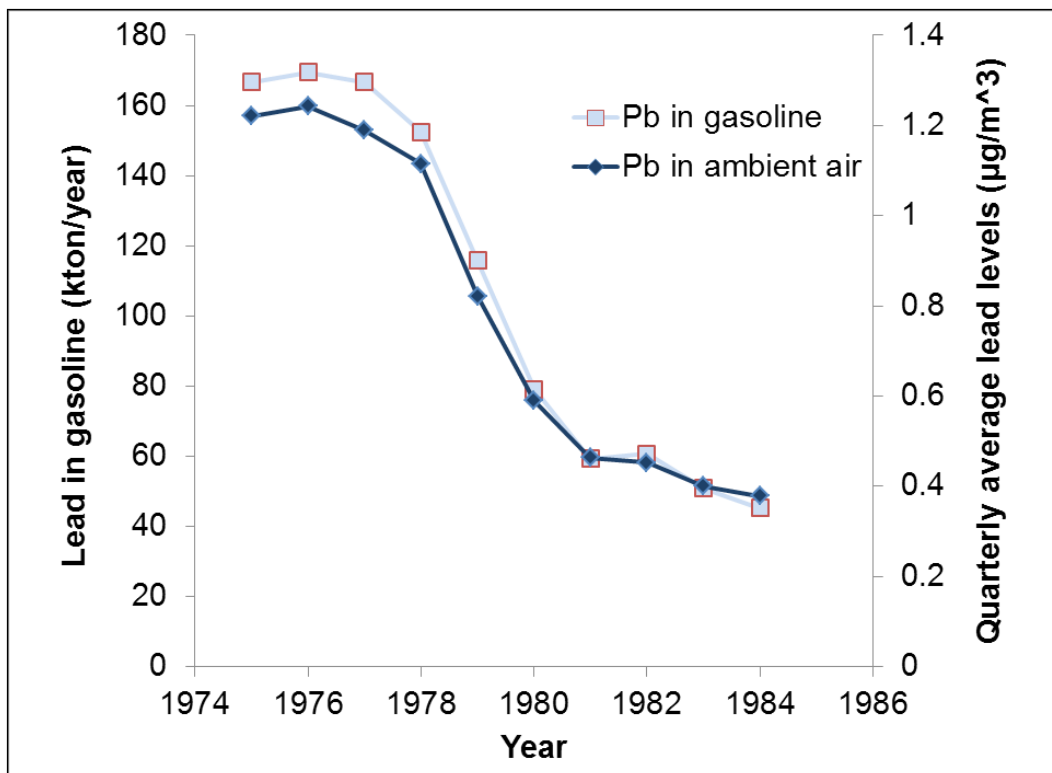

Figure 3-18. Correlation between lead use in gasoline and lead concentrations in the air.

Upon removing lead from gasoline and petrol, lead emissions, and even better, lead contamination of human blood rapidly dropped. Source: US EPA 1986.

3.3.4 Cadmium

Cadmium is a soft, ductile, silver-white or bluish-white metal. It occurs mostly together with zinc sulphide ores or as an impurity in lead and copper ores. The material is used in pigments, coatings, stabilizers, specialty alloys and electronic compounds, but mostly (about 85% in 2010) in rechargeable nickel-cadmium batteries.

Apart from waste during mining and industrial processing, Cd pollution originates mostly from:

- Burning coal (0.25–0.5 ppm) and oil (0.3 ppm)
- Wearing down of car tyres (20–90 ppm)
- Corrosion of galvanised metal (impurity: 0.2% Cd)
- Phosphate fertilisers (phosphate rock 100 ppm Cd)
- Sewage sludge (30 ppm)

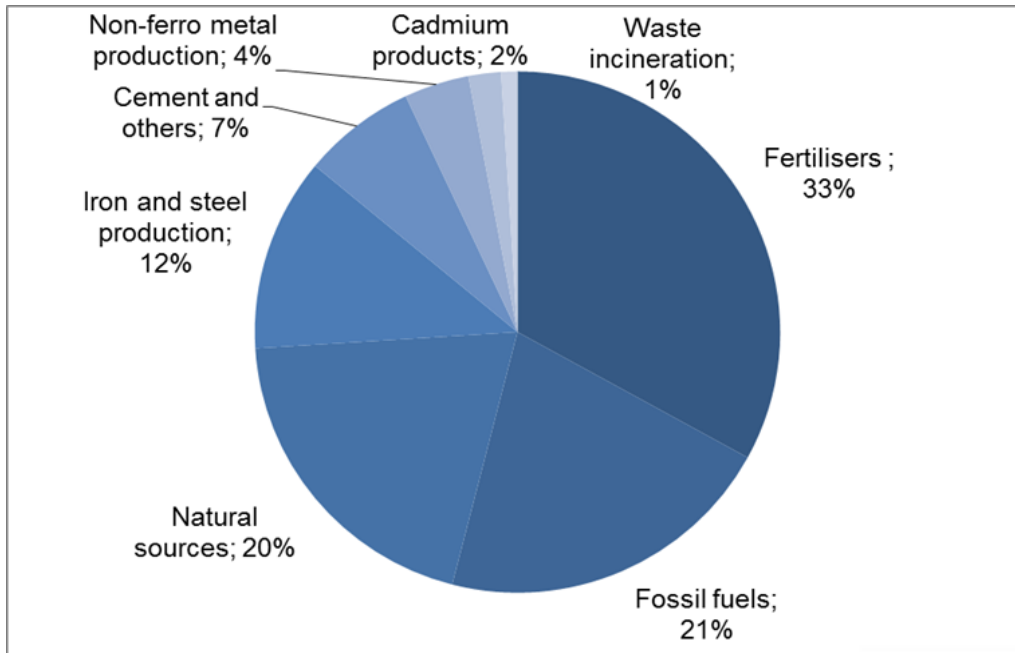

Figure 3-19. Different exposure pathways for Cd in humans

Source: Regoli, Meeting of UNECE Task Force on Heavy Metals, 16 March 2005, Berlin, and www.cadmium.org



MSM

Maastricht School of Management

Increase your impact with MSM Executive Education





For almost 60 years Maastricht School of Management has been enhancing the management capacity of professionals and organizations around the world through state-of-the-art management education.

Our broad range of Open Enrollment Executive Programs offers you a unique interactive, stimulating and multicultural learning experience.

Be prepared for tomorrow’s management challenges and apply today.

For more information, visit www.msm.nl or contact us at +31 43 38 70 808 or via admissions@msm.nl

the globally networked management school



The fact that cadmium posed a real problem for health and environment was made clear in the 1960s, when the metal was revealed in Japan as the cause for itai-itai, a painful bone disease. In that case, the Cd originated from a nearby zinc-lead mine and accumulated in the rice fields downstream. The river water was used as drinking water, and the rice grown in the contaminated fields was eaten. Apparently, the levels were high enough to cause, after thirty years of accumulation, a severe case of itai-itai osteoporosis in the affected people.

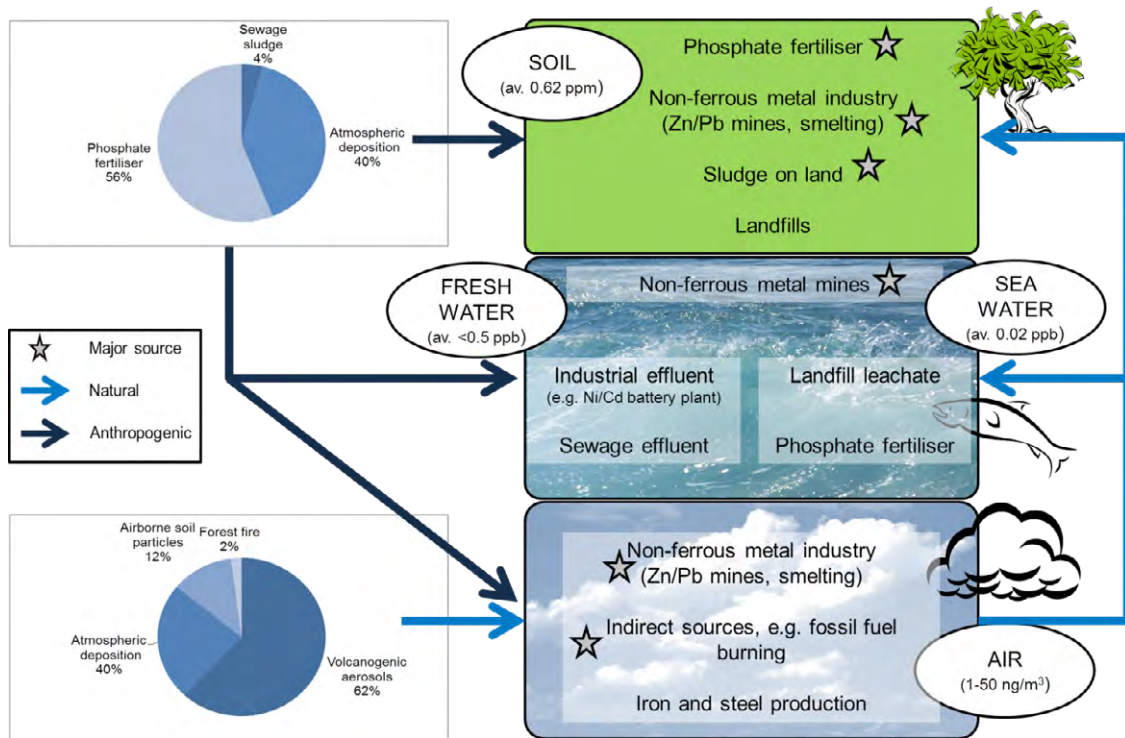

Figure 3-20. Influx of Cd into aquatic ecosystems.
After Pan et al. 2010

More in general, high Cd levels can lead to:

- decreased growth,
- kidney damage (800 $\mu\text{g/g}$ dry weight induces renal damage in humans),
- cardiac enlargement,
- hypertension,
- foetal deformity,
- cancer.

The actual effects of Cd on marine animals is nevertheless relatively small, and few studies have actually proven the link between Cd exposure and any disease symptoms. On the contrary – some marine mammals must possess an efficient detoxification system, as they can tolerate high levels. For example, levels up to 2000 µg Cd per g dry weight were found in Arctic ringed seals, without visible effects on the health of these animals, though (Sonne-Hansen et al. 2002). The same goes for the high levels in baleen whales. There is some evidence that Cd may cause endocrine disruption in silver sea bream (Woo and Man 2011).

3.3.5 Mercury

Mercury is a naturally occurring element that can be found all over the world mostly as cinnabar (mercuric sulphide). In nature, it has been found in several forms: elemental or metallic mercury, inorganic mercury compounds, and organic mercury compounds. Elemental or metallic mercury is a silver-white metal and is liquid at room temperature. If heated, it is a colourless, odourless gas. Mercury is taken up into the food web in one of its organic forms: methylmercury (MeHg) or dimethylmercury (DMHg). This occurs by grazing zooplankton. Also, Hg has a high affinity for lipids, allowing the metal to cross cell membranes and to interfere with cell metabolism (Boening 2000, Pinho et al., 2002). From these organisms onwards, mercury is biomagnified along the food chain up to marine mammals (Table 3-6; Coelho et al. 2010).

Fish & shellfish		Cats		Humans	
oyster	5.6	control	0.9–3.66	control	less than 3.0
gray mullet	10.6	kidney	12.2–36.1	kidney	3.1–144.0
short-necked clam	20.0	liver	37–145.5	liver	0.3–70.5
china fish	24.1	brain	8–18	brain	0.1–24.8
crab	35.7	hair	21–70	hair	96–705

Table 3-6. Mercury in tissue samples from Minamata.
All concentrations are given in ppm. Source: Allchin, sine anno.

The bioaccumulation of mercury has proven to be fatal on a large scale in at least one instant: the disaster at Minamata (Japan) in 1956. Hg entered the local food chain as a result of the release of methylmercury in the industrial wastewater from the Chisso Corporation's chemical factory. The metal then accumulated in shellfish and fish in the local bay, serving as food for the local population.

The severe pollution that ensued brought about a number of neurological problems, such as hearing and speech damage, a perturbed vision, muscle weakness and ataxia, leading, in extreme cases to insanity, paralysis, coma and death.

The discovery of these toxic effects has caused a steady replacement of Hg in a number of production processes and applications. Most of the medical applications have been phased out, such as the antiseptic mercurochrome, or the use of thiomersal in the preservation of vaccines. Mercury-based fever thermometers are banned in the US. The metal is still in use for the production of reference calomel electrodes, mirror telescopes and fluorescent lamps. Due to this decreasing use of the metal, its input into the sea has declined over the past decades, as well. Currently around 75% of the Hg (3600–4500 tonnes). in the marine environment comes from natural sources like eroding ores.

In seawater, dissolved mercury ions occur as HgCl_4^{2-} or HgCl_3^- . They are easily adsorbed to the sediments and the suspended particulate matter, thereby being removed from the solution. They also form complexes with organic molecules in the sea, such as cysteine residues on proteins or humic acids. In anaerobic conditions, Hg may be present in its metallic form, or as sulphide.

Hg^{2+} is further methylated to MeHg and DMHg by bacteria and algae in the photic zone of the ocean. A similar reaction goes on in the (dark) sediments. Other microbes are present to demethylate DMHg to MeHg (Figure 3-21). The methylated forms of mercury are more easily taken up by the organisms on the lowest trophic levels. From there on, the mercury compounds bioaccumulate, as represented for the Arctic ecosystem (Figure 3-22; Kirk et al. 2012).

gaieteye
Challenge the way we run

EXPERIENCE THE POWER OF FULL ENGAGEMENT...

**RUN FASTER.
RUN LONGER..
RUN EASIER...**

**READ MORE & PRE-ORDER TODAY
WWW.GAITEYE.COM**

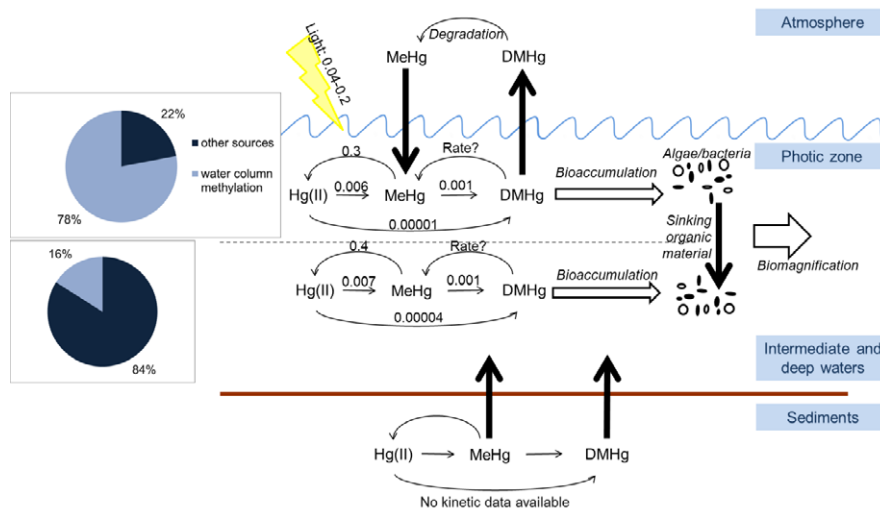

Figure 3-21. Mercury cycling in the Arctic Ocean.

This diagram represents the different processes affecting MeHg concentrations in the water column of the Arctic Ocean: the various Hg methylation and (photo)demethylation pathways (thin arrows), each governed by their respective rate constants (k , expressed in d^{-1} ; values displayed above the arrows) as well as the associated biogeochemical fluxes (thick arrows). The pie charts depict the proportions of MeHg in photic zone and in the deeper waters which are estimated to originate from Hg(II) methylation in the water column (after Kirk et al. 2012).

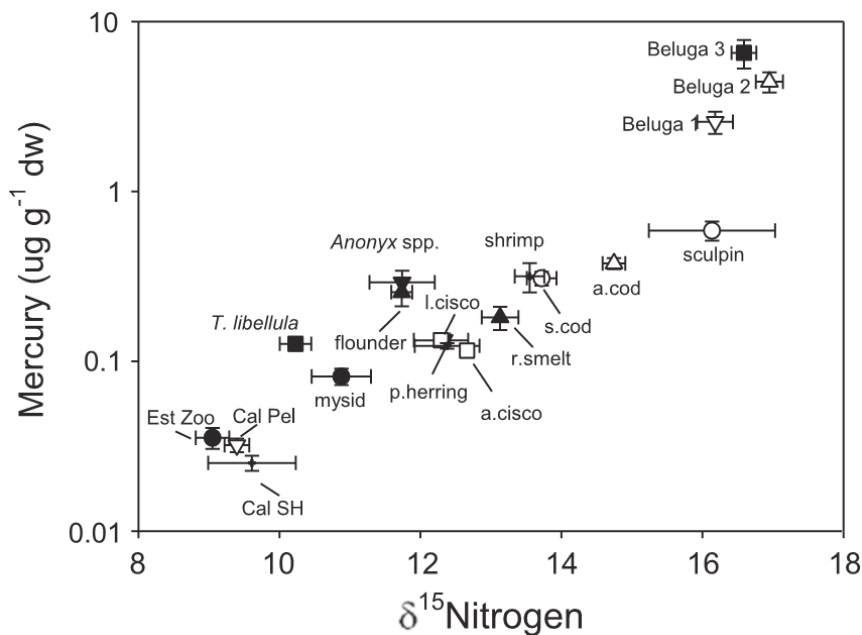

Figure 3-22. Bio-accumulation of mercury in the Arctic food chain.

Invertebrates collected include: calanus copepods collected from the coastal shelf (Cal SH), calanus copepods (Cal Pel) and hyperiid amphipods (*Themisto libellula*) from off-shore pelagic zone, mixed zooplankton from near the coastline (Est Zoo), and mysids, gammarid amphipods (*Anonyx spp.*) and shrimp from benthic zones. Fish collected include: pacific herring, Arctic cisco, least cisco, rainbow smelt, and saffron cod from the coastal shelf, Arctic cod from the off-shore pelagic zone, and flounder and sculpin from the benthic regions. Three groups of beluga whales which utilize different habitats and foraging areas are also shown: Beluga 1: shallow coastal areas; Beluga 2: along ice edges; and Beluga 3: deep off-shore waters. The food chain progression is given as the δ¹⁵N signature. (data from Loseto et al., 2008a, b; figure and legend taken from Kirk et al. 2012)

3.4 Read more?

Allchin, D., The poisoning of Minamata, <http://www1.umn.edu/ships/ethics/minamata.htm>. Visited 11 August 2013.

Boening, D.W. (2000). Ecological effects, transport, and fate of mercury: a general review. *Chemosphere* 40, 1335–1351.

Bricelj, V.M., Haubois, A.G., Sengco, M.R., Pierce, R.H., Culter, J.K., & Anderson, D.M. (2012). Trophic transfer of brevetoxins to the benthic macrofaunal community during a bloom of the harmful dinoflagellate *Karenia brevis* in Sarasota Bay, Florida. *Harmful Algae* 16, 27–34.

Coelho, J.P., Santos, H., Reis, A.T., Falcão, J., Rodrigues, E.T., Pereira, M.E., Duarte, A.C. & Pardal, M.A. (2010). Mercury bioaccumulation in the spotted dogfish (*Scyliorhinus canicula*) from the Atlantic Ocean. *Marine Pollution Bulletin*, 60(8), 1372–1375.

Das, K., Debacker, V., Pillet, S., & Bouquegneau, J.M. (2003). 7. Heavy metals in marine mammals. In J.V. Vos, G.D. Bossart, M. Fournier, T. O’Shea (Eds.) *Toxicology of Marine Mammals*, Taylor and Francis Publishers, Washington D.C, pp. 135–167.

Dodds, W.K., Bouska, W.W., Eitzmann, J.L., Pilger, T.J., Pitts, K.L., Riley, A. J., Schloesser, J.T., Thornbrugh, D.J. (2008). Eutrophication of US freshwaters: analysis of potential economic damages. *Environmental Science & Technology*, 43(1), 12–19.

Doney, S. C., Fabry, V.J., Feely, R.A., & Kleypas, J.A. (2009). Ocean Acidification: The Other CO₂ Problem. *Annual Review of Marine Science* 1, 169–192.

Duce, R.A., Liss, P.S., Merrill, J.T., Atlas, E.L., Buat-Menard, P., Hicks, B.B.,... & Zhou, M. (1991). The atmospheric input of trace species to the world ocean. *Global Biogeochemical Cycles*, 5(3), 193–259.

Flewelling, L.J., Naar, J.P., Abbott, J.P., Baden, D.G., Barros, N.B., Bossart, G.D.,... & Landsberg, J.H. (2005). Brevetoxicosis: Red tides and marine mammal mortalities. *Nature*, 435, 755–756.

Gaskin, D.E. (1982). Environmental contaminants and trace elements: their occurrence and possible significance in Cetacea., In D.E. Gaskin (Ed.) *The Ecology of Whales and Dolphins*. Heinemann, London, p. 393–433.

Järup, L. (2003). Hazards of heavy metal contamination. *British Medical Bulletin*, 68(1), 167–182.

Kirk, J.L., Lehnerr, I., Andersson, M., Braune, B.M., Chan, L., Dastoor, A.P.,... & St Louis, V.L. (2012). Mercury in Arctic marine ecosystems: Sources, pathways, and exposure. *Environmental Research* 119, 64–87.

Loseto, L.L., Stern, G.A., Deibel, D., Connelly, T.L., Prokopowicz, A., Lean, D.R.S., Fortier, L., Ferguson, S.H. (2008a). Linking mercury exposure to habitat and feeding behaviour in Beaufort Sea beluga whales. *Journal of Marine Systems*, 74(3), 1012–1024.

Loseto, L.L., Stern, G.A., Ferguson, S.H. (2008b). Size and biomagnification: how habitat selection explains beluga mercury levels. *Journal of Environmental Science and Technology* 42, 3982–3988.

Maathuis, F. (2009). Physiological functions of mineral nutrients. *Current Opinion in Plant Biology* 12, 250–258.

Masclaux-Daubresse, C., Daniel-Vedele, F., Dechorgnat, J., Chardon, F., Gaufichon, L., & Suzuki, A. (2010). Nitrogen uptake, assimilation and remobilization in plants: challenges for sustainable and productive agriculture. *Annals of Botany*, 105(7), 1141–1157.

McDonough W. Braungart M. (2002) *Cradle to Cradle: Remaking the Way We Make Things*. North Point Press. pp. 193.

DESTINATIONS		GATE	ARRIVAL
INDUSTRY	IMPACT	OW	FASTER
GLOBAL	ASSIGNMENTS	OW	FASTER
SENIOR	CLIENT CONTACT	OW	FASTER
CAREER	DEVELOPMENT	OW	FASTER
MAKE	PARTNER	OW	FASTER

 OLIVER WYMAN



Oliver Wyman is a leading global management consulting firm that combines deep industry knowledge with specialized expertise in strategy, operations, risk management, organizational transformation, and leadership development. With offices in 50+ cities across 25 countries, Oliver Wyman works with the CEOs and executive teams of Global 1000 companies.
An equal opportunity employer.

GET THERE FASTER

Some people know precisely where they want to go. Others seek the adventure of discovering uncharted territory. Whatever you want your professional journey to be, you'll find what you're looking for at Oliver Wyman.

Discover the world of Oliver Wyman at oliverwyman.com/careers

 MARSH & MCLENNAN COMPANIES



- Murozumi, M., Chow, T.J., Patterson, C.C. (1969) Chemical concentration of pollutant lead aerosols, terrestrial dusts and sea salts in Greenland and Antarctic snow data. *Geochimica et Cosmochimica Acta* 33, 1247–1294.
- Nriagu, J.O. (1996). History of global metal pollution. *Science* 272, 223–224.
- Nriagu, J.O. (1989). A global assessment of natural sources of atmospheric trace metals. *Nature*, 338, 47–49.
- Pan, J., Plant, J.A., Voulvoulis, N., Oates, C.J., & Ihlenfeld, C. (2010). Cadmium levels in Europe: implications for human health. *Environmental Geochemistry and Health*, 32(1), 1–12.
- Pinho, A.P.d., Guimarães, J.R.D., Martins, A.S., Costa, P.A.S., Olavo, G., Valentin, J., (2002). Total mercury in muscle tissue of five shark species from Brazilian offshore waters: effects of feeding habit, sex, and length. *Environmental Research* 89, 250–258.
- Sogn Andersen, G., Steen, H., Christie, H., Fredriksen, S., & Moy, F.E. (2011). Seasonal patterns of sporophyte growth, fertility, fouling, and mortality of *Saccharina latissima* in Skagerrak, Norway: Implications for forest recovery. *Journal of Marine Biology*, 2011. <http://dx.doi.org/10.1155/2011/690375>.
- Sonne-Hansen, C., Dietz, R., Leifsson, P.S., Hyldstrup, L., & Riget, F.F. (2002). Cadmium toxicity to ringed seals (*Phoca hispida*): an epidemiological study of possible cadmium-induced nephropathy and osteodystrophy in ringed seals (*Phoca hispida*) from Qaanaaq in Northwest Greenland. *Science of the Total Environment*, 295(1), 167–181.
- US EPA. (1986) Air Quality Criteria for Lead, Vols I to IV. US Environmental Protection Agency, Washington.
- Woo, N.Y., & Man, A. K. (2011). Changes in Endocrine Status in Silver Sea Bream (*Sparus sarba*) Following Cadmium Exposure. In *Bioinformatics and Biomedical Engineering, (iCBBE) 2011 5th International Conference on* (pp. 1–3). IEEE.
- Zehr, J.P., & Kudela, R.M. (2011). Nitrogen cycle of the open ocean: from genes to ecosystems. *Annual review of marine science*, 3, 197–225.

4 Oil and organic pollution

4.1 The polluting organic chemicals

While the previous chapter focused mainly on inorganic components (metals, nitrogen and phosphate ions, carbon dioxide), this chapter moves on to deal with organic molecules. The best known organic pollutant is of course petroleum and its many components. From there we move on to the most important organic compounds in a marine context: polyaromatic hydrocarbons, organic pesticides, polycyclic biphenyls (PCBs) and dioxins (see for example Table 4-1).

Many of these compounds are toxic, highly persistent and lipophilic, which means that they are amenable to bioaccumulation (see 2.1). This toxicity can be acute or chronic, and is in most cases not yet understood very well. Scientists are still figuring out how these components interact with the metabolism of an exposed organism (see for example the discussion later on about dioxins).

Contaminants	Total DDT (ng/g)	Total PCBs (ng/g FW)	Total PAHs (ng/g)	
Edible clams	0.6–3.4	1.6–15.4	2.1–24.5	Binelli and Provini (2003)
Crustacean (crabs, shrimp)	18–24	6.1–14	98–180	Sericano et al. (2001)
Deep sea Fish (<i>Mora moro</i> , muscle tissue)	7.4–12.6	13.8–24.0	0.2–0.6	Sole et al. (2001)
Seabird (Herring gull)	0.2–18.8	0.4–340	0–333	Shore et al. (1999)
Ringed seal blubber	34.8–904	501–6010	65.8–140.7	Kucklick et al. (2002); Holsbeek et al., (1999)

Table 4-1. Concentration ranges of some organic contaminants in marine organisms (taken from Sarkar et al. 2006)

4.2 Oil spills

4.2.1 Composition of petroleum

Petroleum oil is a dark coloured, flammable liquid found throughout the world in underground pockets in the earth's outer layer of rocks. It is not just one simple organic compound, but is a mixture of hundreds, maybe thousands of chemical compounds. In general, these chemicals consist mainly of hydrogen and carbon atoms (the so-called hydrocarbons), giving the oil its hydrophobic character, but that may be all that the individual components have in common.

To distinguish between the different components, one can look at the general chemical class they belong to:

- If the molecules contain only single bonds, they are named alkanes, saturated hydrocarbons or paraffins. Their general formula is C_nH_{2n+2} . Lighter paraffins (C_5H_{12} to C_8H_{18}) are refined into petrol; the ones from C_9H_{20} to $C_{16}H_{34}$ are used for the production of diesel fuel, kerosene and jet fuel. The ones that are even heavier exist as solids at ambient temperature. Paraffin waxes are alkanes with around 25 carbon atoms. Lighter molecules (methane, ethane, propane and butane) are in a gaseous state at ambient temperatures.
- A second group is that of the cycloalkanes or naphthenes. These are saturated hydrocarbons which have one or more carbon rings to which hydrogen atoms are attached according to the formula C_nH_{2n} . Cycloalkanes have similar properties to alkanes but have higher boiling points.
- The aromatic hydrocarbons are unsaturated hydrocarbons which consist of one or more planar six-carbon rings (aromatic or benzene rings). Their general formula is C_nH_n . Some of these components, such as benzene, toluene, ethylbenzene or xylene (abbreviated the BTEX components) are known carcinogens.
- Asphalt and bitumen are the heavyweight hydrocarbon mixtures that are solid at ambient temperature. They usually consist of mixtures of large polyaromatic hydrocarbons.



Day one
and you're ready

Day one. It's the moment you've been waiting for. When you prove your worth, meet new challenges, and go looking for the next one. It's when your dreams take shape. And your expectations can be exceeded. From the day you join us, we're committed to helping you achieve your potential. So, whether your career lies in assurance, tax, transaction, advisory or core business services, shouldn't your day one be at Ernst & Young?

What's next for your future?
ey.com/careers

ERNST & YOUNG
Quality In Everything We Do

© 2010 EYGM Limited. All Rights Reserved.

The average composition of mineral oils has been given in Table 4-2.

Hydrocarbon	Average	Range
Paraffins	30%	15 to 60%
Naphthenes	49%	30 to 60%
Aromatics	15%	3 to 30%
Asphaltics	6%	remainder

Table 4-2. Average composition of mineral oil

Another more practical way to distinguish among the components of a crude oil, uses how easy the components are dealt with after a spill. The International Oil Pollution Compensation Funds (IOPC) distinguishes between non-persistent oil (which is a petroleum based oil that consists of hydrocarbon fractions of which at least 50% by volume distils off at 340°C and 95% by volume at 370°C) and persistent oil (“All oils which are not within the category of non-persistent oil”). This definition is the same as the one used by the Environmental Protection Agency (EPA) in the USA and the USA Coast Guard. The EPA and the Coast Guard define five basic groups. Group 1 consists of the non-persistent oils (jet fuels and gasoline). The persistent oils are then classified further on the basis of their specific gravity, as follows:

- Group 2 oils have a specific gravity less than 0.85;
- Group 3 oils have a specific gravity between 0.85 and 0.95;
- Group 4 oils have a specific gravity between 0.95 and 1.0;
- Group 5 oils have a specific gravity equal to or greater than 1.0.

The National Oceanic and Atmospheric Administration (NOAA) of the USA uses a slightly different distinction:

- Type 1: Very Light Oils (jet fuels and gasoline, the non-persistent oils from above)
- Type 2: Light Oils (such as diesel and light crudes)
- Type 3: Medium Oils (most crude oils)
- Type 4: Heavy Oils (such as Heavy Crude Oils, No. 6 Fuel Oil, or Bunker C)

	Very Light	Light	Medium	Heavy
Volatility	very volatile; gone after one or two days	up to one-third of spill amount left after a few days	two thirds remaining after a few days	little or none
Toxicity	heavily	moderately		
Impact on intertidal areas	none	potentially long-term	severe and long-term	severe and long-term
Impact on sea birds and mammals	moderate	moderate	severe	severe
Clean-up	impossible	can be effective	can be effective	shoreline clean up difficult; long term contamination of sediments

Table 4-3. Types of oil and their physical properties. After Davis et al. 2004

The components that belong to the Very Light Oils are rather toxic (as they are reasonably soluble in the water column) as well as highly volatile (they are supposed to evaporate within 1–2 days), which makes clean-up nearly impossible. The other types are moderately volatile to non-volatile. Still one third remains of the Light Oils after a few days, and two thirds of the Medium Oils. Medium and Heavy Oils can have severe effects on sea birds and sea mammals. Light and Medium Oils can be cleaned when one acts swiftly and effectively; Heavy Oils are difficult to clean up and are bound to contaminate the sediments on the location of the oil spill severely. More details are given in Table 4-3.

Nevertheless – so far the theoretical approach. In reality, disasters rarely happen in a protected area, in good weather conditions, and no flow, so the slick remains in its original position. By the time a team stands by to start with a thorough clean up action, large amounts have already evaporated, sunk, or formed an emulsion that can contain up to 70% water.

4.2.2 Sources of oil contamination

The most spectacular sources of oil contaminations are evidently tanker accidents, such as the one with the Exxon Valdez or the Prestige. The United States National Research Council (NRC) estimated that globally, approximately 1.3 million tonnes of oil are spilled into the sea each year, a number that varies on the whole between 470,000 and 8.4 million tonnes. The newsworthy big spills (presented in Figure 4-2 and Table 4-4) are in this context only a minor source of oil pollution (Figure 4-1).

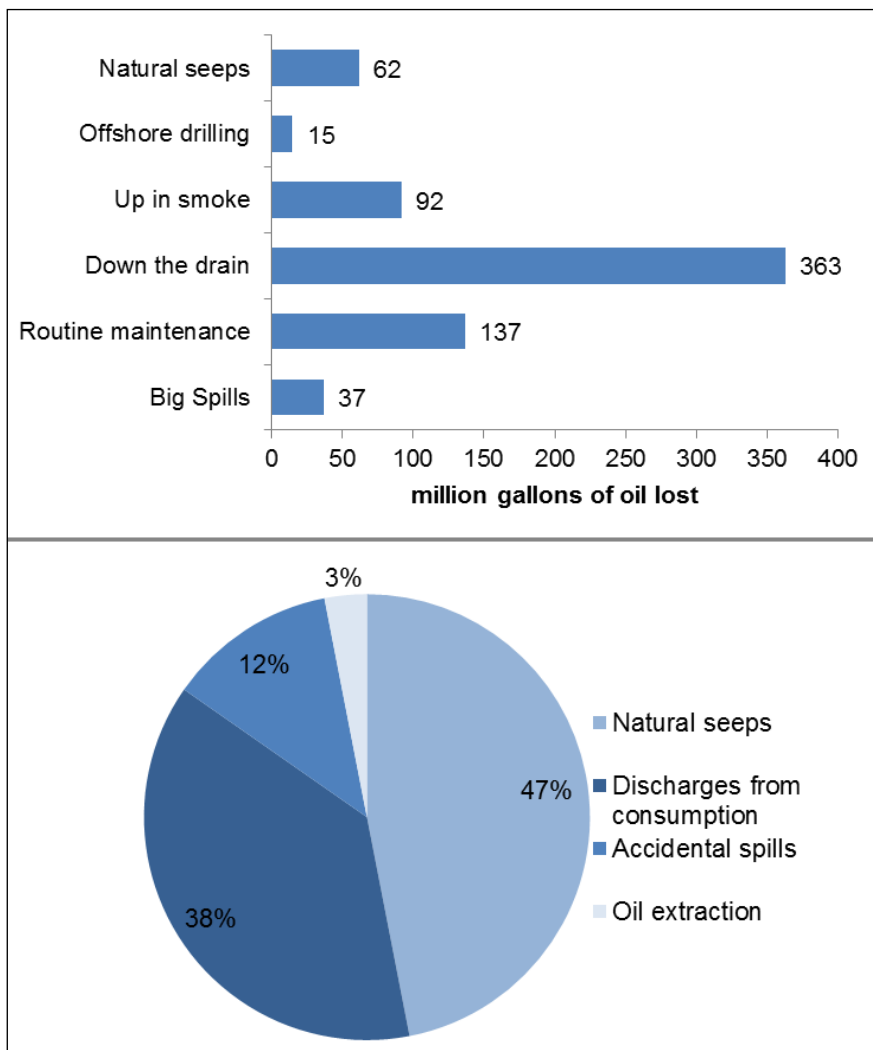

Figure 4-1. Sources of oil spills
 Top: Data for 1985. Bottom: Data for 2002. Source: National Research Council, USA.

On the contrary, the major part of the oil getting into the marine environment originates from evaporating hydrocarbons in tankers/storage, which may be as much as 3.75 million tonnes/year.

The all-over trend looks promising as well: the overall quantity of oil that is spilled dropped significantly since the 1970s, as does the quantity of oil per major shipping accident (Figure 4-2). That is not to say that large spills no longer occur; they do indeed, during loading and discharging, and Table 4-5 shows that 61% of these incidents are caused by fires, explosions and equipment failures. This is to a large extent due to the efforts of the IMO, who launched the MARPOL regulations (see later) on oil in its first Annex in the beginning of the 1980s. This had an immediate effect on both operational and accidental oil spills, as can be seen in Figure 4-2.

Lastly, oil spills due to shipping are dwarfed by a number of spills from other sources, putting everything in a broader perspective. During the Gulf War in 1991, around 9 million barrels of oil⁸ were lost when Iraq set fire to the oil wells. 205 million gallons⁹ were lost during the Deepwater Horizon accident in 2010 in the Gulf of Mexico.

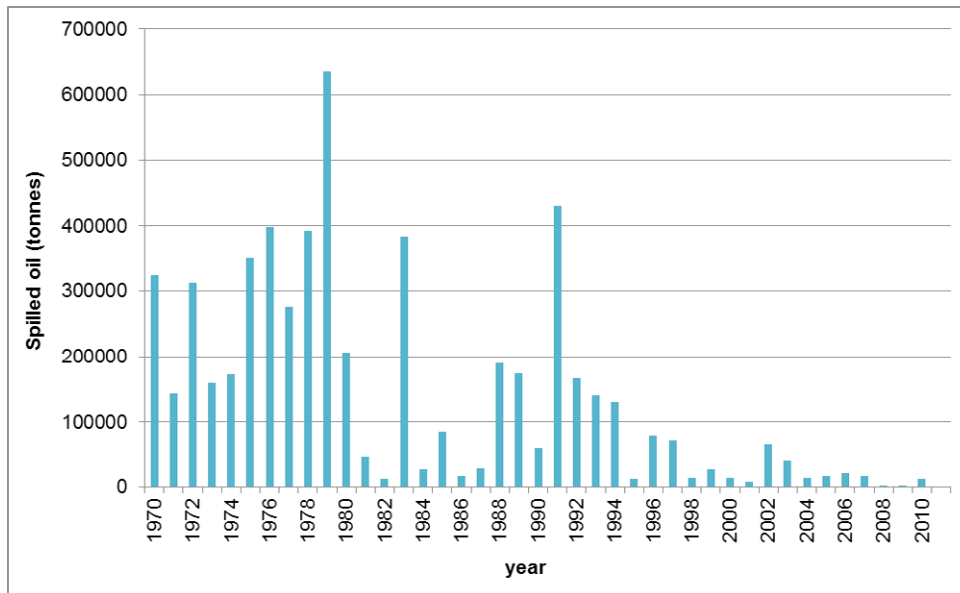

Figure 4-2. Oil spills due to shipping.
 Note that the some years are “famous” and exceptional due to one single large accident (see Table 44)

In the past four years we have drilled

81,000 km

That’s more than **twice** around the world.

Who are we?
 We are the world’s leading oilfield services company. Working globally—often in remote and challenging locations—we invent, design, engineer, manufacture, apply, and maintain technology to help customers find and produce oil and gas safely.

Who are we looking for?
 We offer countless opportunities in the following domains:

- Engineering, Research, and Operations
- Geoscience and Petrotechnical
- Commercial and Business

If you are a self-motivated graduate looking for a dynamic career, apply to join our team.

careers.slb.com

What will you be?

Schlumberger



	Ship	Year	Location	Spill Size (tonnes)
1	ATLANTIC EMPRESS	1979	Off Tobago, West Indies	287,000
2	ABT SUMMER	1991	700 miles off Angola	260,000
3	CASTILLO DE BELLVER	1983	Off Saldanha Bay	252,000
4	AMOCO CADIZ	1978	Off Brittany, France	223,000
5	HAVEN	1991	Genoa, Italy	144,000
6	ODYSSEY	1988	700 miles off Nova Scotia	132,000
7	TORREY CANYON	1967	Scilly Isles, UK	119,000
8	SEA STAR	1972	Gulf of Oman	115,000
9	IRENES SERENADE	1980	Navarino Bay, Greece	100,000
10	URQUIOLA	1976	La Coruna, Spain	100,000
11	HAWAIIAN PATRIOT	1977	300 nautical miles off Honolulu	95,000
12	INDEPENDENTA	1979	Bosphorus, Turkey	95,000
13	JAKOB MAERSK	1975	Oporto, Portugal	88,000
14	BRAER	1993	Shetland Islands, UK	85,000
15	KHARK 5	1989	120 nautical miles off Atlantic coast of Morocco	80,000
16	AEGEAN SEA	1992	La Coruna, Spain	74,000
17	SEA EMPRESS	1996	Milford Haven, UK	72,000
18	NOVA	1985	Off Kharg Island, Gulf of Iran	70,000
19	KATINA P.	1992	Off Maputo, Mozambique	66,700
20	PRESTIGE	2002	Off Spanish coast	63,000
35	EXXON VALDEZ	1989	Prince William Sound, Alaska	37,000

Table 4-4. Major oil spills since 1967.

Source: ITOPF 2012

A) Spills <7 tonnes by operation at time of incident and primary cause of spill, 1974–2011

	LOADING & DISCHARGING	BUNKERING	OTHER OPERATIONS	UNKNOWN
TOTAL	3156	563	1270	2852
Collisions	1	2	11	168
Groundings	2	0	9	228
Hull failures	324	10	47	196
Equipment failures	1123	104	250	202
Fires/ Explosions	50	5	34	84
Other/Unknown	1656	442	919	1974

Table 4-5. Incidence of spills.

Source: ITOPF, 2012

B) Spills 7–700 tonnes by operation at time of incident and primary cause of spill, 1974–2011

	LOADING & DISCHARGING	BUNKERING	OTHER OPERATIONS	UNKNOWN
TOTAL	388	33	136	785
Collisions	4	0	32	308
Groundings	0	0	16	253
Hull failures	36	4	10	50
Equipment failures	141	6	17	38
Fires/ Explosions	8	0	13	26
Other/Unknown	199	23	48	110

C) Spills >700 tonnes by operation at time of incident and primary cause of spill, 1974–2011

	AT ANCHOR	UNDERWAY	LOADING & DISCHARGING	BUNKERING	OTHER OPERATIONS / UNKNOWN
TOTAL	22	307	41	1	83
Allisions / Collisions	11	98	1	0	24
Groundings	6	111	2	0	29
Hull failures	1	50	0	0	8
Equipment failures	0	7	11	0	1
Fires/ Explosions	2	28	14	1	9
Other/Unknown	2	13	13	0	12

4.2.3 Fate of spilled oil

Even when left alone, spilled oil undergoes a number of physicochemical transformations that will lead to its eventual breakdown (see Figure 4-3 for an overview of the processes and Figure 4-4 for how they follow each other during the time after a spill).

First of all, an oil spill will **spread** out (expand) over a large part of the sea surface. This is a physical diffusion process which depends on the viscosity of the oil (and therefore indirectly on the temperature of the surroundings) and which is accelerated by wind and waves. In addition, an oil spill can start to **drift** on the ocean, mainly driven by the waves, in one general direction.

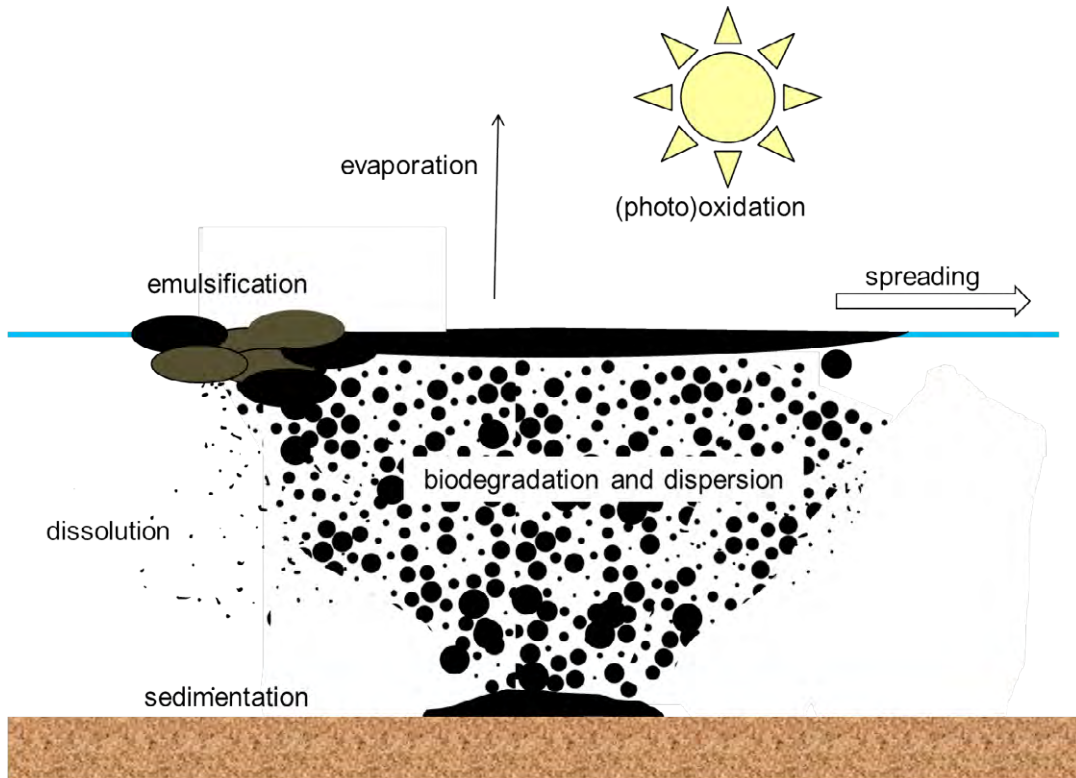



Figure 4-3. Natural degradation of an oil spill



Hellmann's is one of Unilever's oldest brands having been popular for over 100 years. If you too share a passion for discovery and innovation we will give you the tools and opportunities to provide you with a challenging career. Are you a great scientist who would like to be at the forefront of scientific innovations and developments? Then you will enjoy a career within Unilever Research & Development. For challenging job opportunities, please visit www.unilever.com/rdjobs.

Could it be  Unilever



The lighter components of the oil will **evaporate** within a few days (and the more a spill spreads out, the more it will evaporate). The amount that evaporates can be quite substantial. For example, of all the oil that ended up in the sea due to the accident with the Amoco Cadiz (1978, 223,000 tonnes of oil lost – Figure 4-5), 40% was evaporated within three days. Sunlight is able to promote the reaction of the oil components with oxygen gas in the atmosphere (a process called **photo-oxidation**). This process breaks the oil down in water-soluble components or components that will beach under the form of tar balls.

The part on top of the surface can be mixed by wind and waves to form a red-brown water in oil **emulsion** (which is often called chocolate mousse due to its texture and aspect). Some are very stable, others break down by heating or action of the sun. Another part will **disperse** in the water. Here the oil will first break up in small droplets, which will then sink to deeper water levels. The oil pollution from the Braer (1993; 85,000 tonnes) was dispersed completely over the course of a few days. Later on, the molecules in the droplets will even **dissolve** completely in the water (especially the relatively more water soluble, smaller components in the mix, such as benzene and toluene). Many oils also become stickier over time (a process called **weathering**).

The more an oil is dispersed and dissolved in the water column, the faster the organisms (bacteria, fungi, and yeasts) in the water will start with its **biodegradation** to CO₂ and water.

Some heavier oils, with a higher density than seawater, are deposited on the sea bottom or the **sediments** in the shorelines. Other components can **adsorb** to the surface of the material floating in the water column; these materials can sink to the bottom as well.

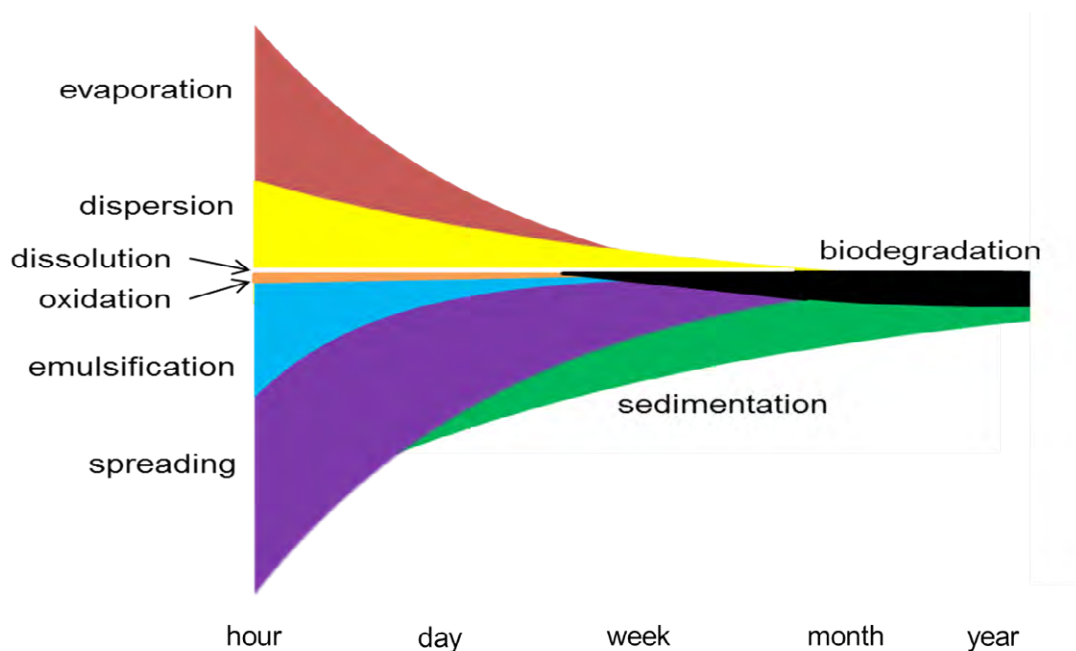

Figure 4-4. Succession in time of the physicochemical processes that transform an oil spill.

Different types of oil demonstrate a different behaviour and reactivity to their physicochemical environment. Most crude oil mixtures emulsify into a stable foam. For example, over 70% of a Fuel Oil No. 6 spill will be left over, either floating or beached, for a week or longer. In contrast, diesel evaporates or disperses spontaneously for about 90% within a few days or even hours. When it comes down to specific components:

- toluene, xylene, propane, ethylacrylate, methanol, acetone and ammonia evaporate
- ammonia, ethylacrylate, hexanol, sulfuric acid, methanol and acetone dissolve
- hexanol, toluene, dioctylphthalate and xylene tend to float
- creosote and trichloroethylene sink to the bottom.



Discover the truth at www.deloitte.ca/careers

Deloitte.

© Deloitte & Touche LLP and affiliated entities.





Figure 4-5. Famous oil spills.
From top to bottom: Amoco Cadiz (Source: NOAA)
Exxon Valdez (Source: NOAA)
Deepwater Horizon (Source: US Coast Guard)

4.2.4 Effects of oil on sea life

Oil spills, and how animals are confronted with these spills, have become the typical image of marine pollution (**Figure 4-6**); (Moore and Dwyer 1974, Piatt et al. 1990).



Figure 4-6. Victims of the Exxon Valdez oil spill.
Photo courtesy of the Exxon Valdez Oil Spill Trustee Council.

The first effect of oil pollution on animals is purely physical. Firstly, the oil blocks the diffusion of atmospheric oxygen into the water, impeding the respiration of all water creatures. Additionally, weathered oil sticks easily to the skin, fur or feathers of marine animals, disrupts their normal structure and obliterates their ability to trap oxygen bubbles between the hairs or feathers, which leads to a loss of their insulating properties. Their buoyancy is affected as well, and therefore also the ability of the animals to swim. The more the oil sticks (especially crude fuels and bunker fuels), the more the animals are subjected to hypothermia and stress.

Furthermore, when the animals try to clean themselves, and groom their fur to get rid of the sticky oil layer, they are bound to ingest a part of it. Also, some fish are attracted to oil because it looks like floating food. Thicker sludge can cover the gills of the fish in the neighbourhood of a spill; volatile components are inhaled and enter the bloodstream through the lungs of birds and mammals. The oil that has been internalised, one way or another, can exert toxic effects on the animals: the oil attacks the mucosa of the gastrointestinal system, leads to ulcers, diarrhea and, if worse comes to worst, internal bleeding and organ damage. The oil also changes the sensitivity of the animal for parasites (Khan 1990). The animals will suffer from anemia and immunotoxic effects (Wootton et al. 2003, Auffret et al. 2004, Hannam et al. 2009), and have a diminished reproductive success (Guzmán et al. 1993, Peterson et al. 2003).

The oil spill can have age- and species specific effects as well. For example, fur seal pups are affected more than adults by oil spills because pups swim in tidal pools and along rocky coasts, whereas the adults swim in open water where it is less likely for oil to linger. Dugongs feed on sea grass along the coast and therefore be more affected by oil spills. In whales, the baleen plates will be clogged, and the nesting habitat of marine turtles can be destroyed.

All in all, the effect of an oil spill on the local fauna can be disastrous. Moreover, a number of possible consequences (such as the incidence of carcinogenesis or other long-term effects) has not been studied in great detail (Peterson et al. 2003).

4.2.5 How is oil pollution cleaned up?

To combat an oil spill (which means, to first block its movements so that it won't overrun the shore with touristic activities or valuable ecosystems, and to remove the oil later on), a lot of expertise has been gathered over the last decades. Several methods can be used, depending on the type of oil, the quantity, the location and the local weather conditions.

Firstly, a cleaning party will try to contain the spill with **oil booms** (Figure 47). Booms are gigantic pieces of plastic, that will block further spreading and drifting by acting as a fence. Booms can consist of mere plastic cylinders, with added weights at the bottom, so that they float closely to the surface. Sorbent booms will consist of a material capable of absorbing the oil. A third type are the fire booms. They are made out of metal, so that they are able to contain oil spills until they can be set on fire. Specialists are against this last method, as this will turn the oil spill in the water into a huge cloud of toxicants, which will often fall out over land, on crops and inhabited areas....

Secondly, they will **adsorb** the oil to sawdust, straw, foam chips, ... or the sorbent booms mentioned in the previous paragraph. Sorbents are often used to finish the cleaning operation, and meant to remove the last traces of oil which could not be skimmed off. The sorbents are added manually and recovered with nets or rakes. This method is useful for smaller spills and near the coastlines, but not for larger ones and in open sea.

Thirdly, they will use boats that can **skim** the oil from the water surface (short: skimmers). These boats pump the oil in the settling tanks they carry. In there, the oil and water can separate out. The oil layer can be refined again (if it is still fresh enough), or be burned.

Alternatively, they can use chemicals to **disperse** the oil in the water column (Figure 4-7). The oil can eventually break down naturally, and chemical dispersants act to speed up the natural process. On the other hand, if the oil is too close to shallow, coastal waters or other biologically sensitive areas, using the chemicals would only heighten the danger for the local fauna and flora. A classic case of trying to choose between two evils. Clean-up efforts will then choose to forego the dispersants and opt for a more laborious, but more nature-friendly way of removing the spill. Once dispersed, the substance will then drift out into the ocean where **micro-organisms** will deal with it. Three groups of bacteria are able to break down spilled hydrocarbons: the anaerobic sulfate-reducing bacteria (SRB) and acid-producing bacteria, as well as general aerobic bacteria (GAB) are aerobic. These naturally occurring organisms will both degrade the oil components as well as take the place of these bacterial populations that were killed off by the oil, thereby restoring the food chain. Since the Exxon Valdez, genetically enhanced microbes can be used to favour biodegradation. On the downside – this is not something that is useful for spills in open sea.



Figure 4-7. Ways to deal with an oil spill.

Top: Oil boom (Sources: left: Mineral Management Service, US Department of the Interior; right: US Coast Guard)

Bottom left: plane spraying dispersants (source: US Air Force);

right: workers cleaning up the shores (source: NOAA, USA)

Burning is a method that is sometimes used to remove oil from the surface of the water, for example in the case of the Deepwater Horizon drilling platform. Oil may also be burned after skimmers remove the oil from the water surface. Nevertheless, this is a method which again causes more problems than it is worth. The burning of oil releases nitrogen and sulfur, which in turn causes acid rain. While burning can remove the oil from the water surface quickly and efficiently, it causes additional pollution. Moreover, in order to light the fire, one needs the more volatile components in the oil... which evaporate quickly and will probably be missing by the time anyone tries to burn the oil.

Any oil that escapes the cleaning operation and the natural degradation will end up on the nearby shores. **Manual labour** is then the best and often only solution to prevent most damage (Figure 4-7), and to clean the land along the shores to avoid further ecological disasters. What can be done and should be done depends upon the ecosystems that will suffer from the spill. When all that is over and done, all that remains is hope that the ecosystems in the affected area are resilient enough to undo the damage caused by the spill, and that the organisms are able to deal with the remaining (and often invisible) pollutants.

Table 4-6 gives an overview of the different shoreline types and how vulnerable they are for oil pollution.

Grant Thornton—^{REALLY} a great place to work.

We're proud to have been recognized as one of Canada's Best Workplaces by the Great Place to Work Institute™ for the last four years. In 2011 Grant Thornton LLP was ranked as the fifth Best Workplace in Canada, for companies with more than 1,000 employees. We are also very proud to be recognized as one of Canada's top 25 Best Workplaces for Women and as one of Canada's Top Campus Employers.



Priyanka Sawant
Manager



Audit • Tax • Advisory
www.GrantThornton.ca/Careers



Grant Thornton
An instinct for growth™

© Grant Thornton LLP. A Canadian Member of Grant Thornton International Ltd



Vulnerability Index	Shoreline type	Comments
1	Exposed rocky headland	Wave reflection keeps most of the oil offshore. No clean-up necessary.
2	Eroding wave-cut platform	Wave-swept shoreline. Natural processes remove most of the oil within a few weeks.
3	Fine-grained sand beach	Oil may sink and/or be buried rapidly, making clean up difficult. Under moderate-to-high energy conditions, oil may persist for several months.
4	Coarse-grained sand beach	Oil may sink and/or be buried rapidly, making clean up difficult. Under moderate-to-high energy conditions, oil will be removed naturally within a few months from most of the beach face.
5	Exposed, compacted tidal flat	Most of the oil will not adhere to, or penetrate into, the compacted tidal flat. Clean-up is usually unnecessary.
6	Mixed sand and gravel beach	Oil may undergo rapid penetration and burial. Under moderate-to-low energy conditions, oil may persist for years.
7	Gravel beach	Same as above. Clean up should concentrate on the high-tide swash area. A solid asphalt pavement may form under conditions of heavy oil accumulation.
8	Sheltered rocky coast	Areas of reduced wave action. Oil may persist for many years. Clean-up is not recommended unless oil concentration is very heavy.
9	Sheltered tidal flat	Areas of great biologic activity and low wave energy. Oil may persist for years. Clean-up is not recommended unless oil accumulation is very heavy. These areas should receive priority protection by using booms or oil-sorbent materials.
10	Salt marsh and mangrove forest	The most productive of aquatic environments. Oil may persist for years. Cleaning of salt marshes, by burning or cutting, should be undertaken only if heavily oiled. Mangroves should not be altered. Protection of these environments by booms or oil-sorbent materials should receive first priority.

Table 4-6. Classification of shorelines in order of increasing vulnerability to oil spills damage.
(After Gundlach & Hayes, 1978)

4.3 Polycyclic aromatic hydrocarbons

Polycyclic aromatic hydrocarbons (PAH) are organic compounds consisting of two or more fused aromatic rings. Especially the higher molecular weight PAHs are hydrophobic, able to accumulate in organisms and sediments. Some of these chemicals are presented in Figure 4-8. Some of their physical characteristics are presented in Table 4-7.

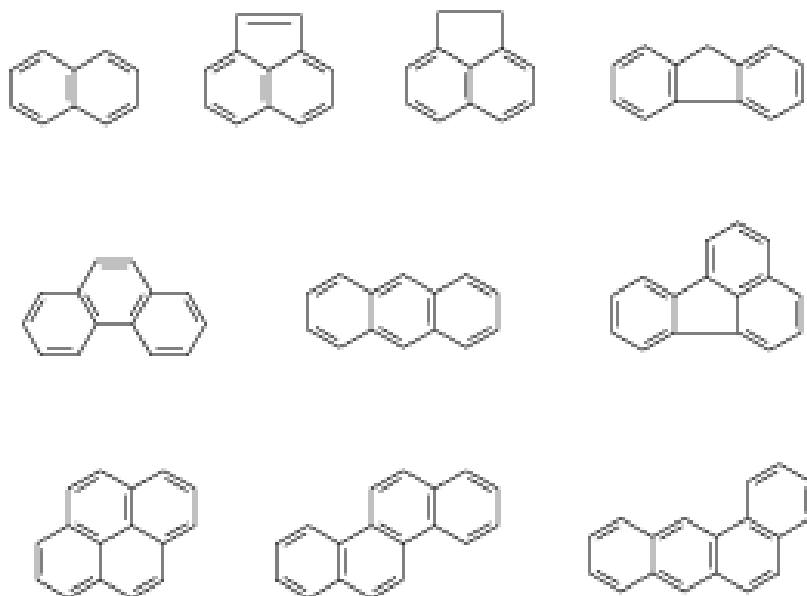

Figure 4-8. Examples of polycyclic aromatic hydrocarbons.

Top: naphthalene – acenaphthylene – acenaphthene – fluorene

Middle: phenanthrene – anthracene – fluoranthene

Bottom: pyrene – chrysene – benzophenanthrene

The Wake

the only emission we want to leave behind

Low-speed Engines Medium-speed Engines Turbochargers Propellers Propulsion Packages PrimeServ

The design of eco-friendly marine power and propulsion solutions is crucial for MAN Diesel & Turbo. Power competencies are offered with the world's largest engine programme – having outputs spanning from 450 to 87,220 kW per engine. Get up front! Find out more at www.mandieselturbo.com

Engineering the Future – since 1758.

MAN Diesel & Turbo



Compound	Molecular weight (g mol ⁻¹)	Boiling point (°C)	Water solubility (mg L ⁻¹)	Log K _{ow}
Naphthalene	128	218	31.7	3.5
Phenanthrene	178	339	1.29	4.45
Anthracene	178	340	0.075	4.46
Fluoranthene	202	375	0.26	4.90
Pyrene	202	393	0.135	4.90
Benz(a)anthracene	228	435	0.014	5.61
Benz(a)pyrene	252	496	0.004	6.50

Table 4-7. Physio-chemical properties of selected PAHs

There are three sources of PAH pollution:

- oil spills, with the PAHs originating in the fossil fuel. Such PAHs are derived from the slow degradation of organic matter and the catagenesis of petroleum under high temperature and pressure. These PAHs are highly alkylated (bearing aliphatic side-chains), which makes a contamination originating from an oil spill easily distinguishable from one of the other two sources.
- incomplete combustion of organic matter. PAHs originating during combustion, the so-called pyrogenic PAHs, are largely unsubstituted. As such, they are a normal constituent of the smoke and the ashes of waste incinerators, but also of bonfires, barbecues and cigarettes.
- use and abuse of coal tar creosote. This is a thick, oily liquid, typically amber to black in color, that is obtained after the distillation of tars. It consists for up to 90% of PAHs. Coal tar creosotes have been used for more than a century to protect wood structures against degradation, as well as for roofing, road paving, aluminum smelting, and coking.

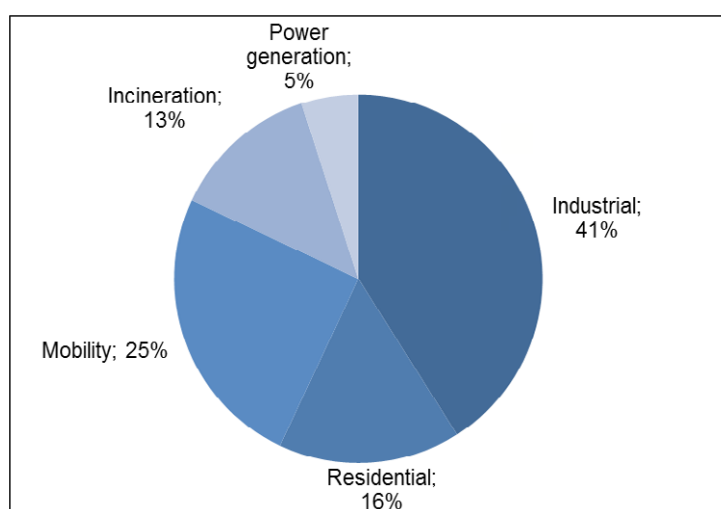

Figure 4-9. Sources of PAHs

Degradation of PAHs by natural means is a matter of microbiological activity. However, as PAHs are hydrophobic compounds (as is evident from the low water solubility and the high K_{ow} values), they will bind strongly to organic matter found in sediments of aquatic environments, instead of being washed out with infiltrating water to the ground water reservoirs. On the other hand, as soils and sediments often contain a mixture of different organic materials, such as polysaccharides, lipids, proteins, lignin and biopolymer-derived humic acids (Nam et al., 1998; Nam and Alexander, 1998, Stevenson, 1998), any PAHs to end up in the sediment are likely to be adsorbed there. As the PAHs will mostly be residing in micropores in the sediment, away from even bacteria, this will slow down and stop any effective for of biodegradation. Indeed, biological breakdown of the PAHs will be limited by the slow desorptive and diffusive mass transfer into more biologically active areas (Zhang et al. 1998). Some scientists even postulate the existence of PAH aliquots that became desorption resistant during a process called aging (Hatzinger and Alexander, 1995). This increases the residence time of the compounds in the soil formidably. Moreover, PAHs have been demonstrated to be incorporated (albeit reversibly) into the humic residue layers in soil, even after partial degradation, which makes them even more immobilized and degradation-resistant (Kästner et al, 1999; Ressler et al. 1999, Orecchio and Mannino 2010).

Bacterial degradation of two- or three-ringed structures is possible under anaerobic conditions, with nitrate or sulfate being used as terminal electron acceptor (Mihelic and Luthy, 1988, Coates et al. 1996). More complex structures can remain in the sediments for decades.

The logo for RBS Group, featuring a stylized sunburst icon to the left of the text "RBS Group".

CAREER KICKSTART

An app to keep you in the know

Whether you're a graduate, school leaver or student, it's a difficult time to start your career. So here at RBS, we're providing a helping hand with our new Facebook app. Bringing together the most relevant and useful careers information, we've created a one-stop shop designed to help you get on the career ladder – whatever your level of education, degree subject or work experience.

And it's not just finance-focused either. That's because it's not about us. It's about you. So download the app and you'll get everything you need to know to kickstart your career.

So what are you waiting for?

Click [here](#) to get started.



In clear water, some photolysis occurs as well, as the conjugated double bonds are sensitive to UV and visual light. As a consequence, half-lives of PAHs are usually much shorter in clear water than when the molecules are bound to the sediments (Table 48).

	clear water	sediments
pyrene	0.75 hours	34–90 weeks
benzo-a-pyrene	0.034 hours	200–300 weeks

Table 4-8. Half lives of different PAHs under different conditions

PAHs are well known genotoxic (mutagenic) and carcinogenic compounds (Brender et al., 2003; Brody and Rudel, 2003). This is due to the ability of some of the reactive metabolites of some PAHs to bind to cellular proteins and DNA, leading to mutations, developmental malformations, tumours and cancer (Malins et al., 1988; Varanasi, 1989; Hoffman, 2003; Ariese et al., 2005; Hoffman, 2003).

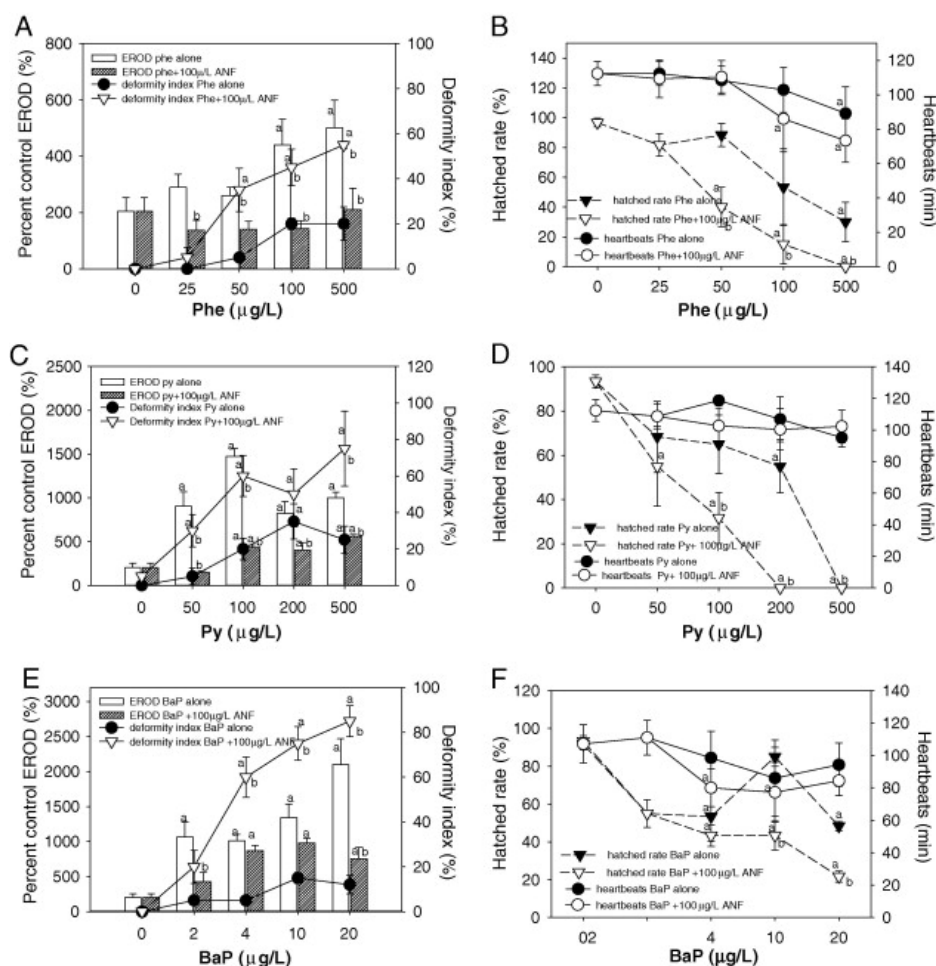

Figure 4-10. Effect of PAHs on embryonic development.

Effects of phenantrene (Phe), pyrene (Py), and Benzo[a]pyrene (BaP) with and without 100 µg/L α -naphthoflavone (ANF) on the embryonic development of marine medaka (*O. melastigma*). In vivo ethoxyresorufin-O-deethylase (EROD) and deformity index (A, C, and E) at 8 dpf; heartbeats per minute (8 days post fertilization, dpf) and hatch rate (18 days) (B, D, and F). Values significantly different from respective DMSO controls are indicated with an "a" ($p < 0.05$). Values significantly different between groups (with and without ANF) are indicated with "b" ($p < 0.05$). Values represent mean (\pm SEM) response of three replicates.

Taken from Mu et al. 2012.

In addition, PAHs affect normal development of larval stadia of different organisms. One such example has been given in Figure 4-10, where larvae of the marine medaka (*Oryzias melastigma*) have been exposed to several three- to five-ring PAHs (phenantrene, pyrene or benzo[a]pyrene), in the presence or absence of α -naphthoflavone. Severe deformities could be spotted, as well as the induction of a biomarker enzyme (ethoxyresorufin-O-deethylase), heart malfunctioning and hatching delays.

After accumulating in the food chain, PAHs are found to affect human health as well, causing cancer or diminishing fertility, for example (Fleming et al., 2006).

4.4 Halogenated hydrocarbons

A separate group of organic pollutants consists of the hydrocarbon chains which bear one or more halogen atoms (F, Cl, Br, I) as substituents.

4.4.1 Pesticides: DDT, lindane, ...

The best known insecticide in history, even decades after its worldwide ban in agriculture (see Table 4-9 for a short overview of the history of the substance), is probably DDT (dichlorodiphenyltrichloroethane). It is an organochlorine insecticide.

First synthesis in Zeidler, Germany	1874
Paul Mueller discovers insecticidal properties	1939
Paul Mueller wins Nobel prize for Medicine	1948
Mass introduction into agriculture and public health programs	1949 onward
Development of trace analytical techniques;	1950–1960
Recognition of residues in tissues and ecosystems and their significance	1960–1970
Restriction in usage in US	1969–1970
Banned in developed world Use limited in developing countries	1970–1980

Table 4-9. The history of DDT: curiosity, common usage, catastrophe

The compound has been labelled as only “moderately toxic”, given a LD_{50} of 113 mg/kg (for oral uptake by rats). Its real danger lies more in its long term effects. Indeed, DDT has been implicated in different health problems in humans and animals:

- DDT and its first metabolite DDE (see Figure 4-11) have been linked to diabetes, Parkinson and asthma (van Wendel de Joode 2001, Brown 2007, Philibert et al. 2009).
- DDT and DDE are known to act as pseudo-oestrogens (see 0), causing problems in in semen quality, menstruation, gestational length, and duration of lactation (Rogan and Chen 2005).
- Developing foetuses exposed to DDT are more likely to endure development problems and the presence of even low levels of DDT or DDE in the umbilical cord serum at birth is correlated with decreased attention at infancy and decreased cognitive skills at 4 years of age (Ribas-Fitó et al. 2006, Torres-Sánchez et al. 2007, Sagiv et al. 2008).
- DDT has been linked to liver pancreas and breast cancers (Rogan and Chen 2005, Eskenazi et al. 2009).

ORACLE®

Be BRAVE

enough to reach for the sky

Oracle's business is information - how to manage it, use it, share it, protect it. Oracle is the name behind most of today's most innovative and successful organisations.

Oracle continuously offers international opportunities to top-level graduates, mainly in our Sales, Consulting and Support teams.

If you want to join a company that will invest in your future, Oracle is the company for you to drive your career!

<https://campus.oracle.com>



ORACLE®

ORACLE IS THE INFORMATION COMPANY



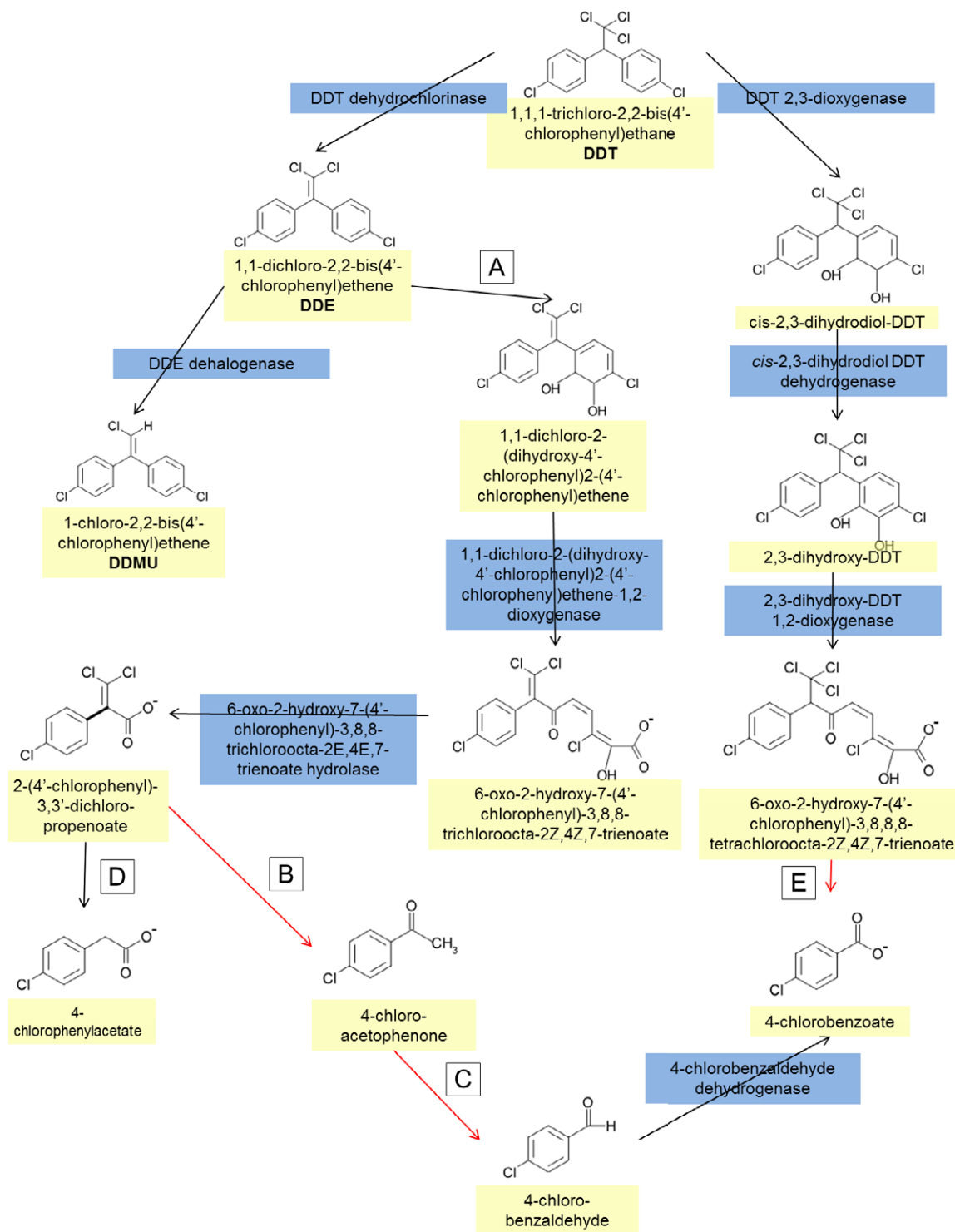

Figure 4-11. Aerobic breakdown of DDT with formation of different metabolites. Yellow boxes give compound names, blue boxes give the responsible enzymes. The steps labeled A, B, C, D, E are steps whose intermediates are not identified yet. Re arrows denote probable multistep reactions. (Taken from Gao et al. (2010), http://umbbd.ethz.ch/ddt/ddt_map.html).

Next to DDT, there is a whole series of chlorinated insecticides (depicted in Figure 412) which turn up in the oceans:

- Lindane (γ -hexachlorocyclohexane or γ -HCH) is a compound that has served as a pesticide in agriculture and for the treatment of lice infestations. It acts as a neurotoxin by interfering with the regular neurotransmitter γ -aminobutyric acid (GABA). Unborn children that come into contact with this substance may suffer problems in brain development. It is still unclear whether lindane is an endocrine disruptor, or carcinogenic. Agricultural use is banned; pharmaceutical use is still possible in shampoos against head lice (till 2015).
- Hexachlorobenzene (HCB) is a fungicide formerly used as a seed treatment until it was banned. It is carcinogenic and affects proper liver function.
- “Drins” is a common name for the now banned chlorinated insecticides aldrin, dieldrin and endrin. They are quite persistent, biomagnify along the food chain and degrade to equally toxic or even more dangerous compounds.
- Toxaphene is a mixture of approximately 200 organic compounds, formed by the chlorination of camphene. This insecticide affects the lungs, nervous system, and kidneys, and may cause death. It is a carcinogen.

Except for the first one, they have all been listed among the “Dirty Dozen”, twelve compounds that received priority attention in the so-called Stockholm Convention (Table 4-10). Most of these compounds were banned from the moment this Convention was ratified – on 17 May 2004, 90 days after the ratification by the fiftieth country.

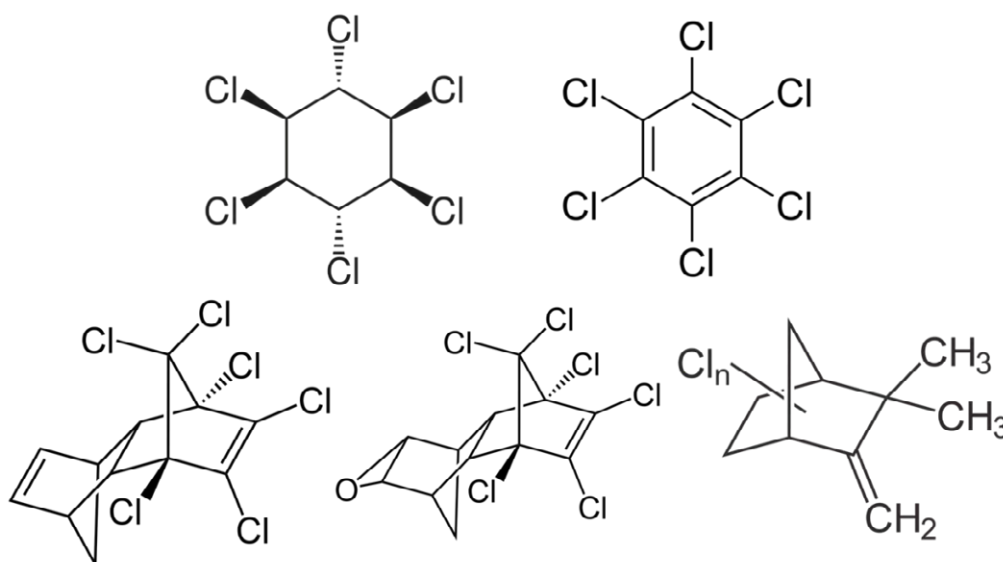

Figure 4-12. Chlorinated insecticides.
 Top, left: lindane; right: hexachlorobenzene
 Bottom, left: aldrin; middle: dieldrin; right: toxaphene.

Chemical or Class	Notes
Aldrin	Pesticide widely used on corn and cotton until 1970. EPA allowed its use for termites until manufacturer cancelled registration in 1987. Closely related to dieldrin.
Chlordane	Pesticide on agricultural crops, lawns, and gardens and a fumigant for termite control. All uses were banned in the United States in 1988 but still produced for export.
DDT	Pesticide still used for malaria control in the tropics. Banned for all but emergency uses in the United States in 1972.
Dieldrin	Pesticide widely used on corn and cotton until 1970. EPA allowed its use for termites until manufacturer cancelled registration in 1987. A breakdown product of aldrin.
Endrin	Used as a pesticide to control insects, rodents, and birds. Not produced or sold for general use in the United States since 1986.
Heptachlor	Insecticide in household and agricultural uses until 1988. Also a component and a breakdown product of chlordane.
Hexachlorobenzene	Pesticide and fungicide used on seeds, also an industrial by-product. Not widely used in the United States since 1965.
Mirex	Insecticide and flame retardant not used or manufactured in the United States since 1978.
Toxaphene	Insecticide used primarily on cotton. Most uses in the U.S. were banned in 1982, and all uses in 1990.
PCBs	Polychlorinated biphenyls, widely used in electrical equipment and other uses. Manufacture of PCBs banned in the United States in 1977.
Polychlorinated Dioxins and Polychlorinated Furans	Two notorious classes of "unintentional" pollutants, by-products of incineration and industrial processes. Regulated in the United States under air, water, food quality, occupational safety, waste, and other statutes.

Table 4-10. The "Dirty Dozen"

The Stockholm Convention on Persistent Organic Pollutants identified an initial twelve chemicals or chemical groups for priority action. They were banned for agricultural use.

Source: <http://www.uspopswatch.org/global/dirty-dozen.htm>

Between 80 and 99% of these compounds ends up in the ocean due to atmospheric deposition. The remainder of the input of organochlorines comes from rivers (Table 4-11). All of them are quite persistent in the environment (Table 4-12) and will finally end up in living tissue of sea mammals (Table 4-13), after biomagnification in the food chain (Table 4-16).

Effects of these organochlorine insecticides on sea organisms further comprise:

- fertility problems (in sea urchins, Pesando et al. 2004, Figure 413)
- ultrastructural changes in liver cells (in rainbow trout, Biagianti-Risbourg et al. 1996)
- anatomical changes, necrosis, atrophy and hypertrophy (in seabream, Oliva et al. 2008; in *Etroplus maculatus*, Bijoy Nandan and Nimila (2012), Figure 414)
- behavioural changes (in *Etroplus maculatus*, Bijoy Nandan and Nimila (2012), Table 414)

	Atmosphere	Rivers	% atmospheric
HCH	4754	10–80	99
HCB	77	4	95
Dieldrin	43	4	91
DDT and metabolites	165	4	98
Chlordane	22	4	85
PCBs	239	40–80	80

Table 4-11. Atmospheric and river input of different halogenated hydrocarbons into the ocean (in tons/year).

Insecticide	Years Since Treatment	Percent Remaining
Aldrin	14	40
Chlordane	14	40
Endrin	14	41
Heptachlor	14	16
Dilan	14	23
Isodrin	14	15
Benzene hexachloride	14	10
Toxaphene	14	45
Dieldrin	15	31
DDT	17	39

Table 4-12. Persistence of chlorinated hydrocarbon insecticides in agricultural soils.
Taken from: Nash and Woolson (1967)

	Bowhead whale	Beluga whale	Northern fur seal	Pilot whale	Common dolphin	Harbor seal
	North Pacific/Atlantic Ocean			North Atlantic		
PCB 28	4	1	6	32	ND	ND
PCB 52	16	92	21	145	1270	1110
PCB 101	16	115	12	301	1350	1760
PCB 118	9	85	87	264	1400	620
PCB 138	13	14	181	614	5960	21190
PCB 153	15	169	206	750	6540	16970
PCB 180	6	52	67	451	3000	9600
Total of these 7 PCBs	79	678	580	2557	19520	51250
Extrapolated total of all PCBs^(a)	316	2712	2320	10228	78080	205000
α	105	196	103	27	81	120
β	35	129	287	10	32	10
γ	20	47	12	10	17	10
Total of these 3 HCHs	160	372	402	47	130	140
4,4'-DDT	20	360	4	966	1807	2720
4,4'-DDD	7	108	144	419	2700	100
4,4'-DDE	34	432	3596	2417	14700	16150
2,4'-DDT	ND	224	NQ	440	NQ	NQ
2,4'-DDD	6	28	4	76	164	10
2,4'-DDE	4	24	ND	75	110	10
Total of these 6 DDTs	71	1176	3748	4393	19481	18990

Table 4-13. Concentrations of some polychlorinated biphenyls and chlorinated pesticides in blubber of various marine mammals from the Northern hemisphere in ng/g (ppb) extractable lipids. Taken from Mössner and Ballschmiter (1997)

n.d. – not detected (< 1 ng/g); n.q. – not quantified because of coelution

^(a) Total of all PCB = Total of these 7 PCBs x 4 (the multiplication factor 4 derives from the assumption that the PCB composition in the samples is similar to an Aroclor standard mixture 1242:1254: 1260 (1:1: 1))

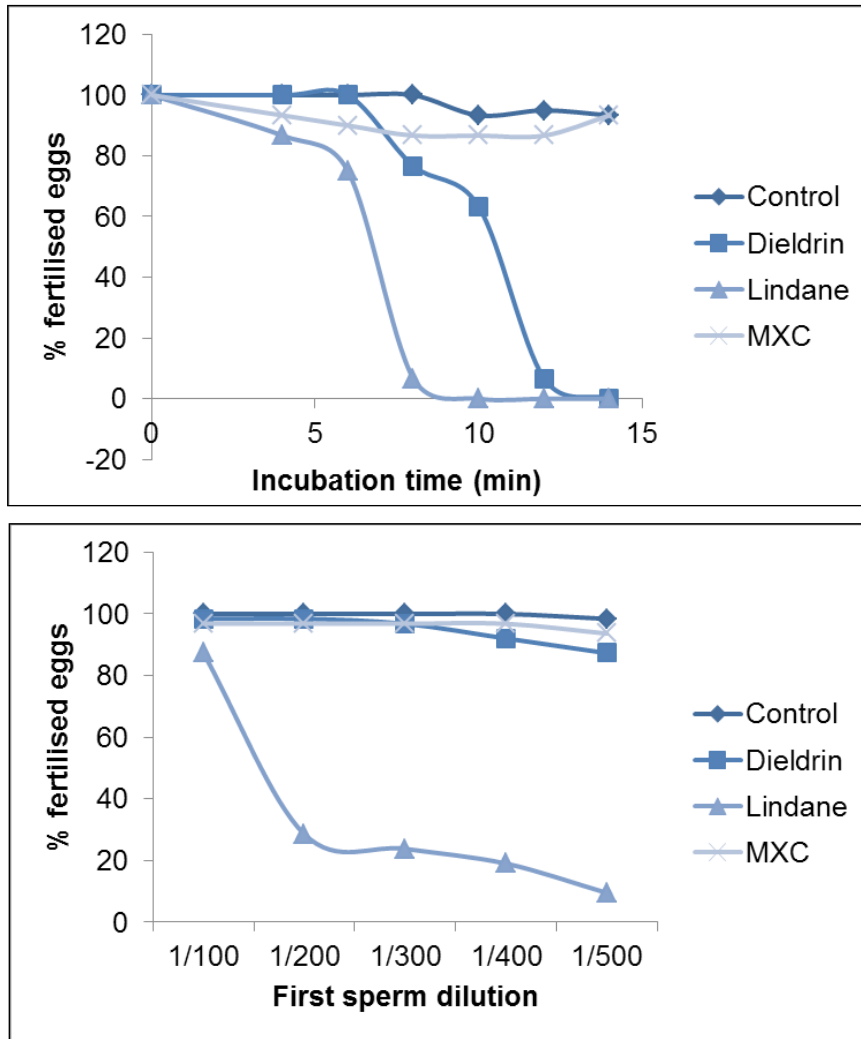

Figure 4-13. Effect of dieldrin, lindane and methoxychlor (MXC) on sperm functioning in the sea urchin *Paracentrotus lividus*. Top: Effect of increasing incubation time on sperm. Bottom: Effect of increasing sperm dilutions on fertilization. Taken from Pesando et al. 2004.

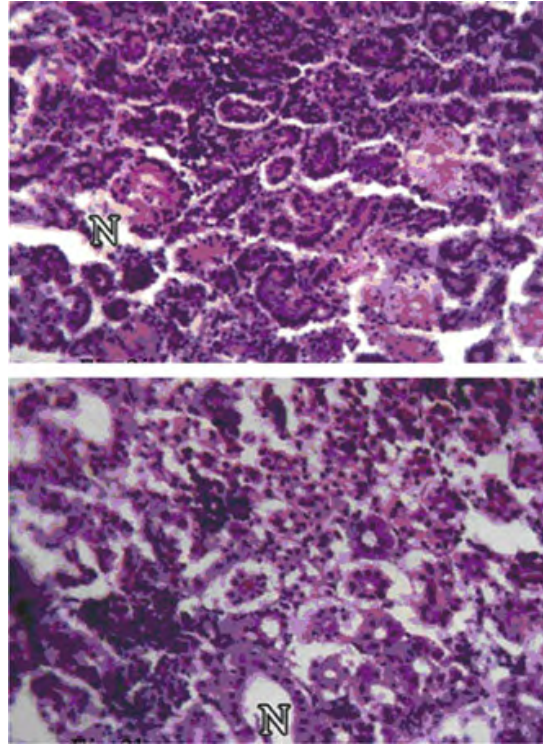
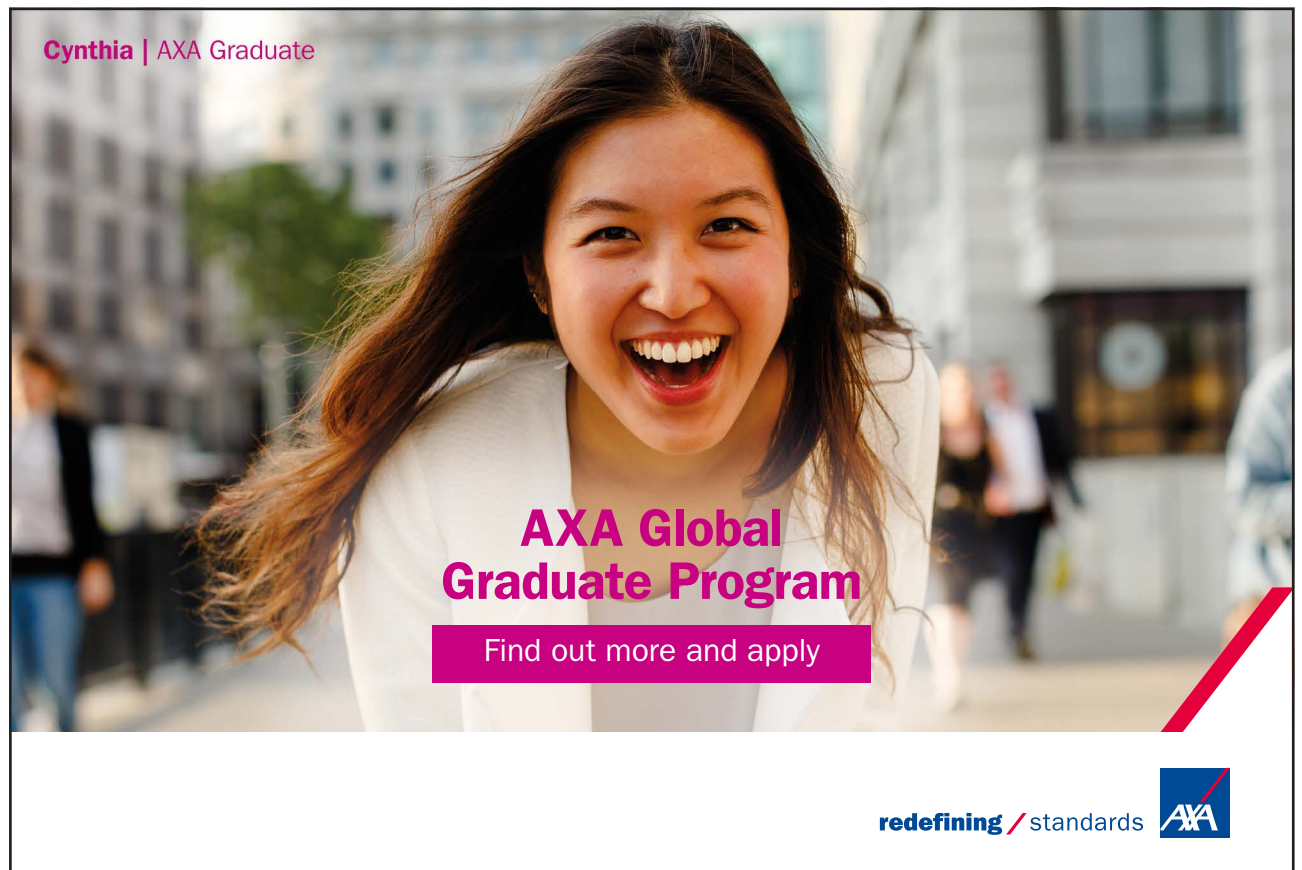

Figure 4-14. Kidney necrosis due to lindane treatments
1. Necrosis (N) in kidney of *E. maculatus* exposed to 0.005 mg/L of lindane for 10 days.
2. Necrosis (N) in kidney of *E. maculatus* exposed to 0.005 mg/L of lindane for 30 days. Taken from Bijoy Nandan and Nimila (2012)

Cynthia | AXA Graduate



AXA Global Graduate Program

Find out more and apply

redefining / standards AXA



Parameters	Control	Solvent control	Sublethal concentrations		
			0.001 mg/L	0.002 mg/L	0.005 mg/L
Coughing	29.5 ± 2.12	31 ± 2	38.5 ± 2*	41.5 ± 2*	44.5 ± 2*
Yawning	12.5 ± 0.7	13 ± 1	16 ± 1*	19.5 ± 0.7*	22 ± 0.7*
Fin-flickering	188 ± 2	187.5 ± 6	209 ± 1	224 ± 5*	241 ± 7*
partial jerk	39 ± 1	40 ± 1	45 ± 1*	56 ± 2*	63 ± 2*
Burst swimming	21 ± 1	22.5 ± 2	32 ± 2*	43.5 ± 3*	52 ± 1*
Nudging	41 ± 1	41.5 ± 0.7	49 ± 1*	57 ± 1*	63.5 ± 2*
Threatening	61.5 ± 3	62.5 ± 2	73 ± 2*	85 ± 2*	96 ± 2*

Table 4-14. Behavioural responses in *Eetroplus maculatus* exposed to lindane

The fishes were hyper-excited and restless. The frequency of other unusual behaviors, such as coughing, yawning, fin flickering, threatening, nudging and nipping, were all increased as a consequence of the pesticide poisoning. Data are presented as mean frequency/5fishes/2 h), as value ± SD. *: significance level at $p < 0.001$. Taken from Bijoy Nandan and Nimila (2012)

4.4.2 Polyhalogenated biphenyls

A second group of halogenated organic compounds are the polychlorinated or polybrominated biphenyls (PCBs, resp. PBBs). These molecules consist of two aromatic rings linked together via an extra covalent bond; all other positions may bear a Cl or a Br atom as a substituent. The general formula for these compounds is $C_{12}H_{10-y}X_y$, with X representing a Cl or a Br. All in all, 209 congeneric PCB's are possible. A few examples are shown in Figure 4-15.

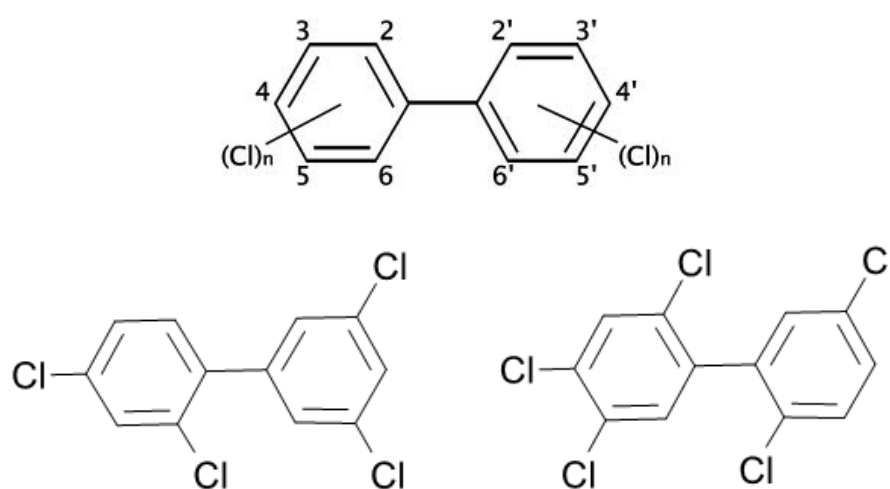

Figure 4-15. Top: general structure of a PCB; bottom: examples of PCBs.

Unlike the PAHs, PCBs and PBBs are synthetic compounds – that is, they are entirely man-made. PCBs are used as lubricants, elastomers, plasticizers, components of paints and ink, and serve as heat conductors in electrical transformers. PBBs are used as flame retardants of the brominated flame retardant group. They are added to plastics used in products such as home electrical appliances, textiles, plastic foams, laptop cabinets, etc.... These molecules are quite resistant to any form of degradation, and are extremely stable in the presence of heat, acids or bases.

Groups		n	Lipid (%)	PCBs	PBDEs	HBCDs
Lung nematode	Not infected	10	6.5 (0.89–14)	15000 (730–22000)	210 (12–400)	180 (7.2–1200)
	Infected	10	3.4 (1.2–8.3)	23000 (3900–81000)	340 (55–1200)	98 (8.9–380)
Liver trematode	Not infected	12	6.2 (1.7–14)	9700 (730–17000)	190 (12–400)	62 (6.4–260)
	Infected	8	2.9 (0.89–8.3)	32000 (5400–81000)	400 (76–1200)	250 (13–1200)

Table 4-15. Correlation between parasitic infection and exposure to organohalogenes in liver of finless porpoise (ng/g lipid wt). Numbers represent mean value (minimum – maximum). Taken from Isobe et al. (2011).

Moreover, as they are lipophilic and resistant to biodegradation, PCBs and PBBs are prone to high levels of accumulation, first in the organic fraction of the sediment (comparable to the PAHs), and then in the food chain (Table 4-16). The higher the number of substituents, the less they seem to bioaccumulate, probably because of the selective activity of the cell membrane.

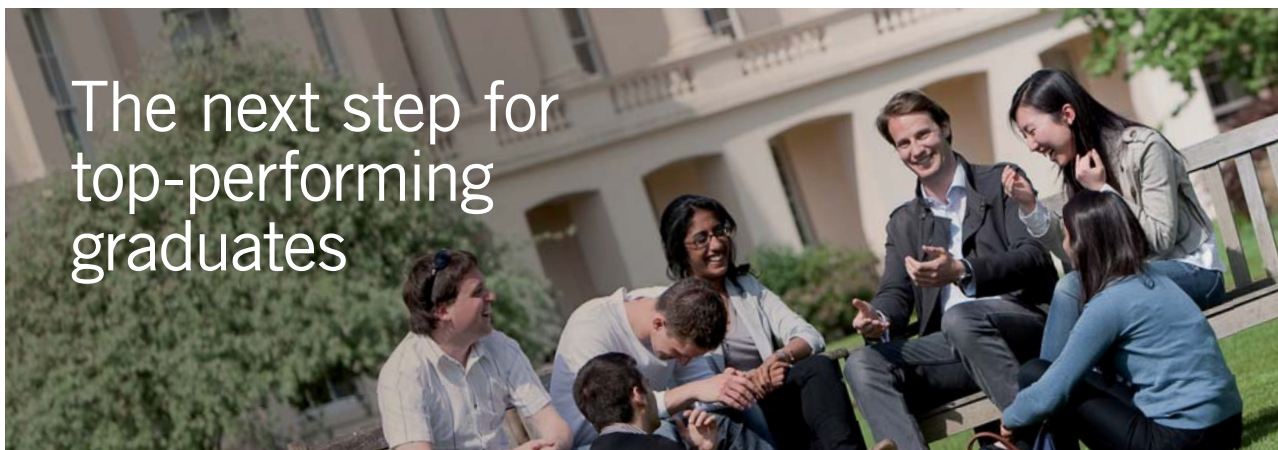

Masters in Management



Designed for high-achieving graduates across all disciplines, London Business School’s Masters in Management provides specific and tangible foundations for a successful career in business.

This 12-month, full-time programme is a business qualification with impact. In 2010, our MiM employment rate was 95% within 3 months of graduation*; the majority of graduates choosing to work in consulting or financial services.

As well as a renowned qualification from a world-class business school, you also gain access to the School’s network of more than 34,000 global alumni – a community that offers support and opportunities throughout your career.

For more information visit www.london.edu/mm, email mim@london.edu or give us a call on +44 (0)20 7000 7573.

* Figures taken from London Business School’s Masters in Management 2010 employment report



Organisms	n	Lipid %		Σ HCHs		HCB		Σ Chlordanes		Σ DDTs		Σ PCBs	
Copepods	2	1.4	1.5	21	26	13	14	11	12	23	25	44	46
Amphipods	2	3.2	3.5	30	33	17	22	20	23	17	19	38	50
Polar cod	3	7.1±0.7		37±3.4		39±1.7		76±3.2		17±1.4		108±8.5	
Cod	3	3.8±0.2		41±3.2		65±7.7		100±3.8		42±1.0		205±17.1	
Brünnich's guillemot	10	2.5±0.5		45±13		578±96		192±21		1077±140		1782±233	
Black guillemot	10	4.4±0.8		36±4.1		335±30		292±21		715±89		2188±247	
Black-legged kittiwake	11	3.6±0.7		43±9.3		866±131		448±69		1471±283		17 980±3299	
Glaucous gull	15	4.1±0.5		253±46		4090±689		5530±970		41 937±5961		130 442±33 936	

Table 416. Organochlorine concentrations in organisms from the Barents Sea (ng g⁻¹ lipids). Taken from Borgå et al. 2001.

- In crustaceans, two samples (pooled whole organisms) were analysed, and both results were listed in the table. Mean ng g⁻¹ lipid weight ± standard error, were given for the other organisms.
- Σ HCHs, sum of α -, β - and γ -hexachlorocyclohexane.
- Σ Chlordanes, sum of *cis*-chlordane, oxychlordane and *trans*-nonachlor.
- Σ DDTs, sum of *p,p'*-DDT, *p,p'*-DDE, *p,p'*-DDD.
- Σ PCBs, sum of polychlorinated biphenyl congeners

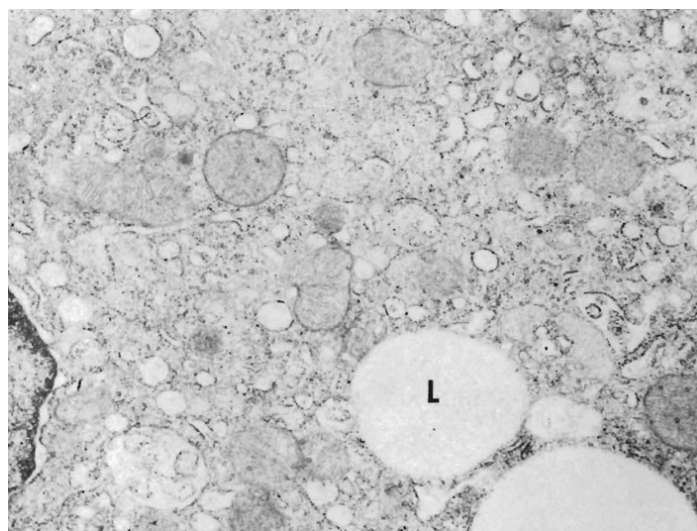

Figure 416. Detail of a PCB-affected fish hepatocyte.

The picture shows vesicular profiles of smooth and rough endoplasmic reticulum and lipid droplets (L). Magnification 25,000 x. Taken from Hinton et al. 1978.

Accession (or identifier)	Category	Description	Fold-change			
			Male		Female	
			PCB126	KC-400	PCB126	KC-400
AF500194	Reproduction	Choriogenin L	-5.41	-3.09	-2.62	-3.16
AB025967		Choriogenin H	-1.74	-1.44	-2.11	-2.62
AB064320		Vitellogenin 1	-2.03	-2.08	3.47	1.51
AF355473		Germ cell-less protein	-2.57	-2.16	-2.67	-2.40
AF128805		Factor In, the germline alpha transcription factor	-1.78	-1.59	-2.02	-1.91
AB076399	Endocrine	Androgen receptor alpha	-2.38	-2.66	-1.86	-1.86
AB041336		Gonadotropin-releasing hormone	-1.91	-1.85	-2.45	-2.36
AB057676		Gonadotropin-releasing hormone receptor 2	2.28	2.05	1.88	1.54
ECO016036	Glycolysis and	Glyceraldehyde-3-phosphate dehydrogenase	1.91	2.16	1.76	1.79
AU176739	Gluconeogenesis	Fructose-1,6-bisphosphate aldolase	1.76	1.70	2.17	2.23
BM187523		Glucose-6-phosphatase	4.01	4.74	2.69	1.46
BJ011623		Aldolase B	2.12	1.67	1.60	1.38
AJ012193	Citrate cycle	Malate dehydrogenase	2.39	2.30	2.80	2.30
AB084721	Electron transport	Cytochrome b	1.57	1.51	1.62	2.12
AJ457701		Cytochrome oxidase subunit 3	2.07	1.51	1.64	1.58
AJ012191		ATPase protein	2.71	2.57	2.47	2.84
AJ457223		ATP synthase, H ⁺ transporting, mitochondrial	2.57	2.65	2.15	1.98
AV670845	Stress response	Stress-associated endoplasmic reticulum protein 1	4.53	5.01	3.60	3.62
AB163431	Drug metabolism	Heme oxygenase 1	-1.02	1.38	1.07	2.10
BJ002707		Epoxide hydrolase 1	-1.93	-1.84	-2.27	-2.16

Table 4-17. Genes affected by two types of polychlorinated biphenyl exposures in the liver of Japanese medaka. Taken from Nakayama et al. 2011.

In terms of acute toxicity, PCBs fall in the same range as aspirin (based on their LD₅₀ of 2-10 g/kg body weight after oral uptake in rats). The best visible symptoms after acute dioxin and PCB exposure is chloracne. However, their true danger is best visible after chronic exposure. Chronic exposure leads to:

- **liver problems**, as indicated by changes in the liver cells' ultrastructure, hepatocytomegaly (swelling of the cells) and hyperplasia (increase of the organelles) (Hinton et al. 1978, Figure 4-16) as well as in its biochemical functioning (Kuzyk et al. 2003; Nakayama et al. 2011 and Table 4-17);
- a **dysfunctional reproduction** (Nakayama et al. 2011 and Table 4-17);

- as can be seen in the reduction in size of the gonads. This is indicated with the gonadal somatic index GSI:

$$\text{GSI} = \text{gonad weight} / \text{Body weight}$$

PCBs affect estrogen metabolism and reduces GSI of several fish species, such as Japandes medaka (*Oryzias latipes*, Ma et al. 2005) or white perch (*Morone americana*, Monosson et al. 1994). Other markers for fertility were affected as well, such as egg mortality (Monod 1985) or vitellogenin production (the precursor protein for egg yolk; Monosson et al. 1994, Flouriot et al. 1995, Kraugerud et al. 2012).

- **immunosuppression**, and subsequently a greater susceptibility for infectious diseases. For example, in 1987, 700 bottlenose dolphins (*Tursiops truncatus*) were found dead on the east coast of the USA (50% of migrating population). The animals exhibited opportunistic infections indicative of immune dysfunction, as well as high levels of PCBs and DDT (Lahvis et al. 1995). Comparable correlations were found between *Morbilivirus* (distemper virus) infections and PCB levels in common seals (*Phoca vitulina*) and striped dolphins (Aguilar and Borrell 1994, Baird 2001, Lowenstine 2004)
- **disruption of the endocrine system** (Table 4-18, Besselink et al. 1996, Le Roy et al. 2006)
- the development of **cancer** (see also Van den Berg et al. 2006). For example, high PCB levels in belugas (*Delphinapterus leucas*) in Saint-Lawrence, Canada, correlated with cancer incidence and diminished reproduction (Martineau et al. 1994)



Get Internationally Connected at the University of Surrey

MA Intercultural Communication with International Business
MA Communication and International Marketing



MA Intercultural Communication with International Business

Provides you with a critical understanding of communication in contemporary socio-cultural contexts by combining linguistic, cultural/media studies and international business and will prepare you for a wide range of careers.

MA Communication and International Marketing

Equips you with a detailed understanding of communication in contemporary international marketing contexts to enable you to address the market needs of the international business environment.

For further information contact:

T: +44 (0)1483 681681

E: pg-enquiries@surrey.ac.uk

www.surrey.ac.uk/downloads



Click on the ad to read more

It needs to be added that marine mammals which have accumulated high levels of lipophilic pesticides in their adipose tissue usually succumb to the toxins when they are forced to turn on their body reserves for their survival. The lipids in the blubber are being consumed, and the large amounts of toxins are re-released into the animals' bloodstream, sometimes even leading to acute toxicity effects.

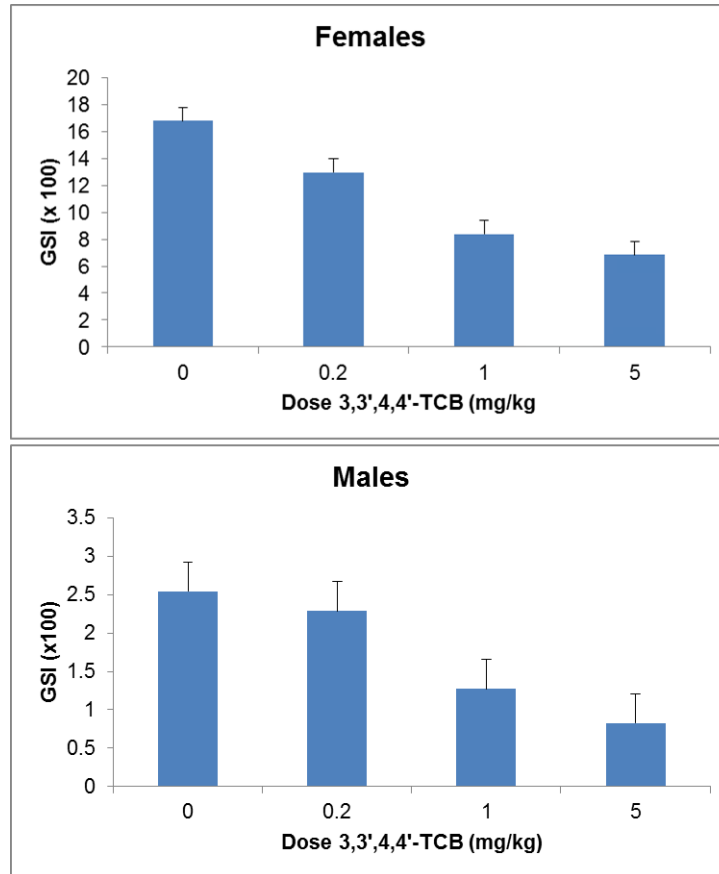

Figure 4-17. Gonadal somatic index after exposure to different amounts of TCB three times a week for three weeks in white perch (*Morone americana*). The asterisk indicates a statistically significant value at $p < 0.05$. Taken from Monosson et al. (1994).

Dose Clophen A50 (mg/kg)	Total T4 in plasma (nmol/L)	Total T3 in plasma (nmol/L)	Free T4 in plasma (pmol/L)
Day 2			
0	4.95±0.89	1.95±0.36	6.58±1.08
20	4.49±0.60	2.32±0.66	4.99±0.75
100	5.61±0.77	5.34±0.90	6.67±1.54
500	5.76±0.87	2.89±0.43	11.43±1.56
Day 10			
0	5.21±0.54	2.58±0.53	7.00±0.57
20	2.62±0.33	1.88±0.55	3.68±0.40
100	5.77±0.57	3.19±0.29	10.94±1.75
500	4.03±0.52	3.16±0.41	9.01±0.85

Table 4 18. Thyroid hormones changes due to exposure to PCBs.

Flounders were exposed to clophen A50 on day 0. Data are expressed as mean ± standard error. The thyroid hormones, triiodothyronine (T3) and thyroxine (T4), are tyrosine-based hormones produced by the thyroid gland that are primarily responsible for regulation of metabolism.

Taken from Besselink et al. 1996

4.4.3 Dioxins

The last group of organic pollutants to be discussed in this section are the dioxins. They consist of two (poly)chlorinated aromatic hydrocarbons with one or two ether groups linking both aromatic rings. They can be divided into:

- polychlorinated dibenzo-p-dioxins (PCDDs), a term which is usually shortened to dioxin (while, technically, dioxin itself is a smaller molecule, on which the PCDDs are based – see). There are 75 PCDDs, seven of which are toxic molecules. .
- polychlorinated dibenzofurans (PCDFs), shortened to furans. There are 135 different forms, ten of which have dioxin-like properties.

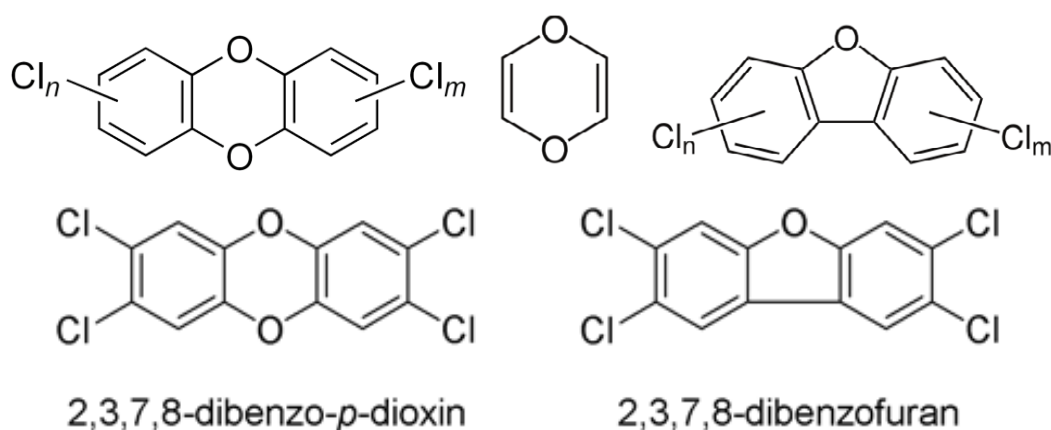

Figure 4-18. Dioxins and furans.

Top: general structure for a PCDD – dioxin, sensu stricto – general structure for a PCDF.

Bottom: examples of a PCDD and a PCDF.

Dioxins are products of every combustion of organic material, as long as there is some chlorine left. The process is furthermore catalysed by a range of metals, such as copper. The optimal temperature of dioxin formation lies between 400 and 700°C, meaning that whenever organic material is burned in less-than-optimal conditions (open fires, building fires, domestic fireplaces, poorly designed waste incinerators,...), a substantial quantity of dioxins is produced. At higher temperatures, even the dioxins will be oxidised further. This was a common flaw in waste incinerators; nevertheless, this flaw has been corrected in most modern installations. This has led to a severe decline of the daily intake in humans from several hundred picograms per day in the 1980s to 50–200 picograms per day (1–3 pg/kg*day) in late 1990s. Other as yet historical sources were the chlorine-based bleaching process of paper and the use of dichloroethane in leaded engine fuel. Nowadays, apart from combustion, dioxins are produced in the metal industry, during the synthesis of a number of chlorinated chemicals. The compounds are also found in some natural clays (like kaolin), and in the remains of natural wildfires.

Dioxins can be considered among the most dangerous chemical pollutants ever on the planet. They are listed among the UN Dirty Dozen (Table 4-10). The compounds are very persistent, tend to bioaccumulate due to their lipophilic character and some of them are quite toxic. This becomes all the more clear when one considers the chemical accident in an industrial plant near the Italian village of Seveso in 1976. This resulted in the highest known human exposure to 2,3,7,8-tetrachlorodibenzo-p-dioxin (TCDD, the most toxic form). The most visible direct symptoms are chloracne and a delay of menstruation. However, researchers suspect that TCDD exposure, in the long run, causes liver damage, diabetes and immunological problems, and affects haem metabolism as well as thyroid gland functioning. Apart from that, a decrease in sperm count and motility were observed in male Seveso survivors (Mocarelli et al. 2008).

TCDD is also one of the main impurities in Agent Orange. This was a mixture of two herbicides (2,3-dichlorophenoxyacetic acid and 2,3,5-trichloroacetic acid), meant to defoliate the trees in the tropical rainforest in Vietnam and to take away the cover for the Vietcong opposition during the Vietnam war in the 1960s. Survivors on both sides of the war blame the use of Agent Orange for their continuing health problems (Schechter et al. 2002). Vietnam estimates that 500,000 children born with birth defects due to the TCDD exposure, and The Red Cross of Vietnam estimates that up to 1 million people have health problems due to Agent Orange. Lastly, dioxins have been linked to reproductive problems of the white tailed eagles and the seals in the Baltic Sea, and to an increased mortality of salmon fry mortality, the so called M74 syndrome (Bignert et al. 1989, Vuorinen et al. 1998, 2002 Helander et al. 2002).

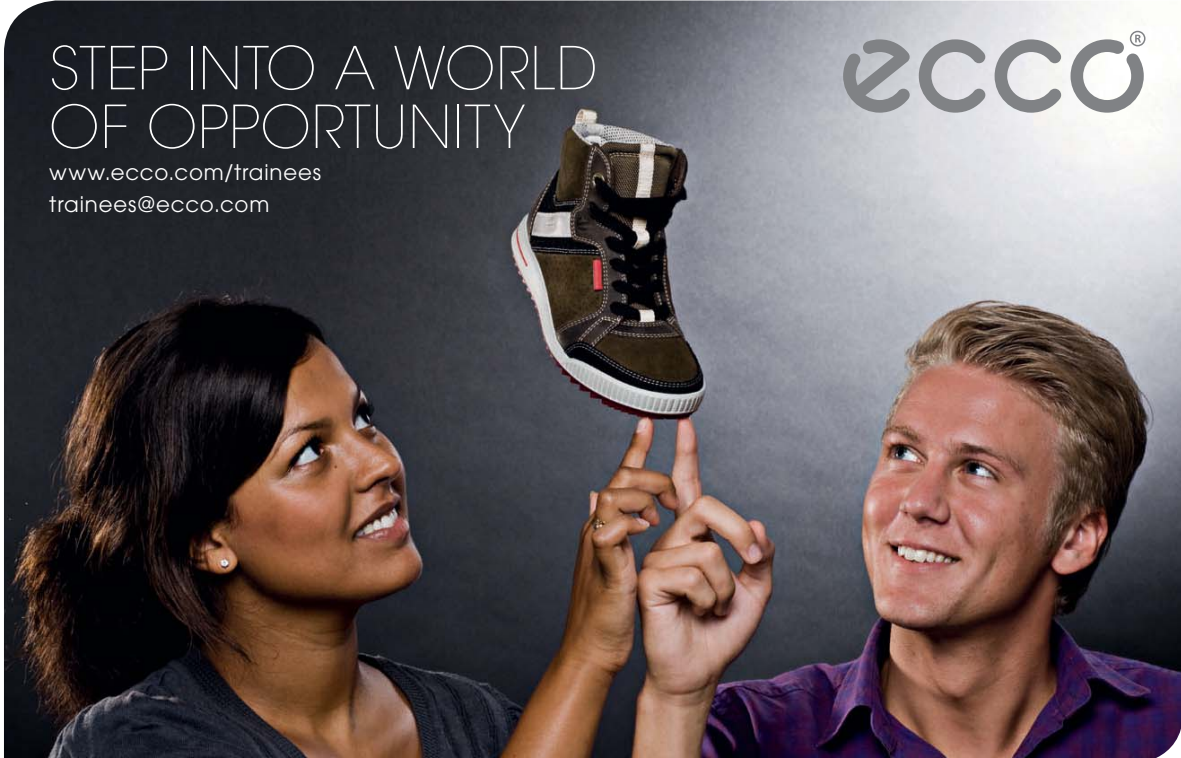

STEP INTO A WORLD
OF OPPORTUNITY

www.ecco.com/trainees
trainees@ecco.com

eCCO[®]

The advertisement shows a woman on the left and a man on the right, both smiling and looking upwards. They are holding their index fingers up, balancing a brown and white high-top sneaker on the tips of their fingers. The background is a dark, textured grey.



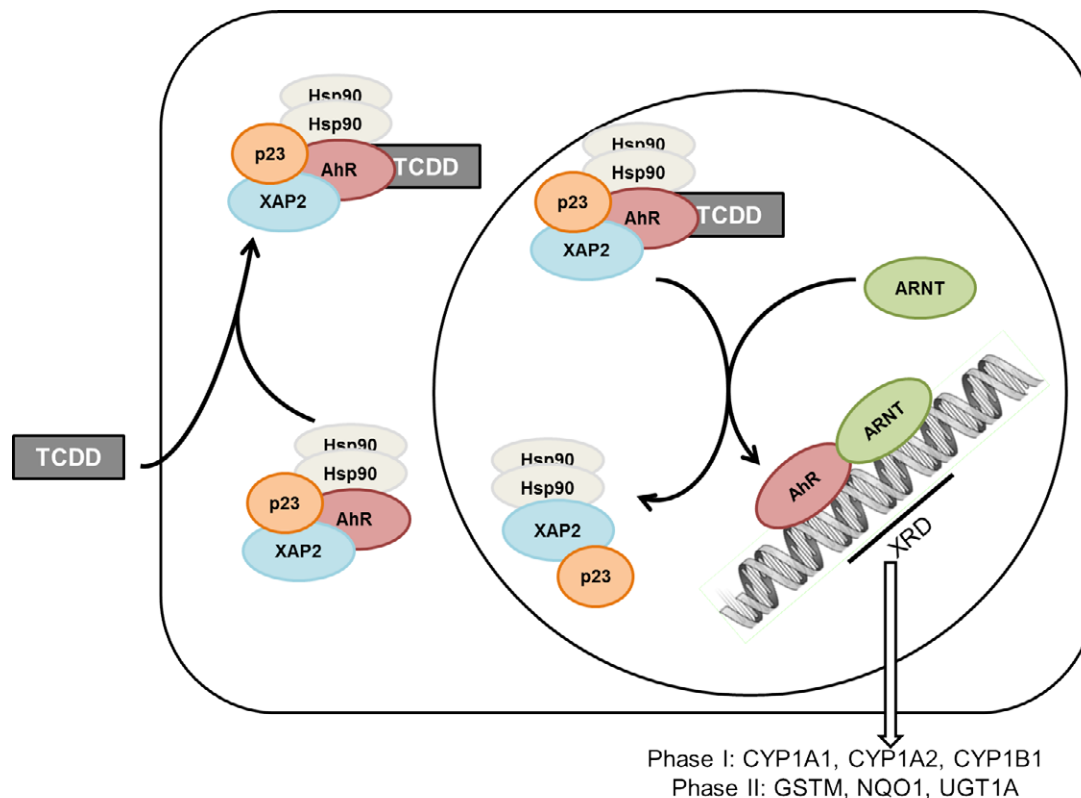

Figure 4-19. Dioxin signalling leads to an enhanced detoxification.
After Dietrich and Kaina (2010)

Mechanistically, TCDD binds on the aryl hydrocarbon (AH) receptor. This receptor is located in the cytoplasm; binding of a ligand causes the protein to be translocated to the nucleus. There the AhR dissociates from the complex and forms a dimer with ARNT which will act as a transcription factor. This will first induce the expression of the genes for the family of cytochrome P450 1A enzymes, which will then proceed to break down toxic compounds (see 2.4.1). Moreover, the AhR-ARNT complex also activates genes such as COX2 (the gene for Prostaglandin endoperoxide synthase 2) or Slug (which represses E-cadherin transcription in breast carcinoma) (Gasiewicz et al. 2008).

When the AhR-ARNT complex later on recruits additional co-factors it will also induce other proteins, such as GSTM (glutathione-S-transferase M), NQO1 (NAD(P)H:quinone oxidoreductase 1), UGT1A (uridine 5'-diphosphate-glucuronosyltransferase 1A) or ALDH (aldehyde dehydrogenase) (Figure 4-19).

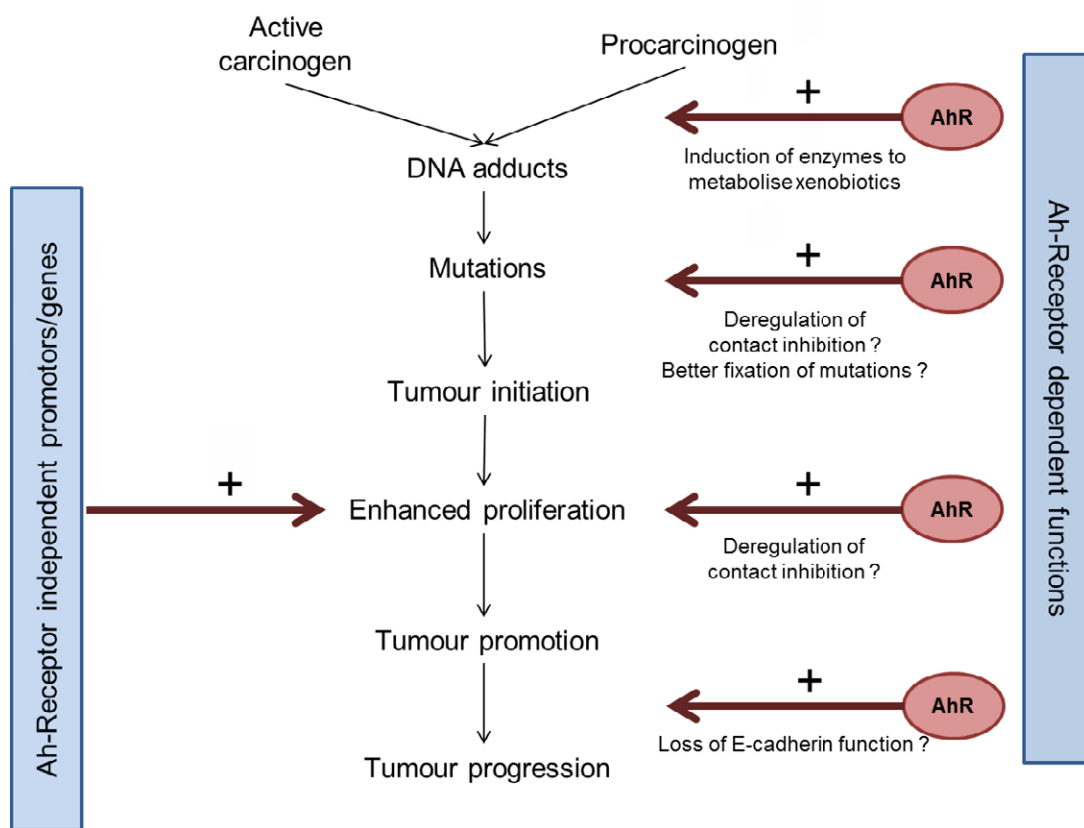

Figure 4-20. Possible mechanism for tumour formation through the aryl hydrocarbon receptor. Hypothetical model of the role of AhR in tumor initiation, promotion and progression. Procarcinogens such as PAHs are known to activate the canonical xenobiotic-responsive element-dependent pathway, thereby leading to their conversion to genotoxic metabolites forming DNA adducts. Mutations are fixed by clonal expansion of initiated cells. Non-genotoxic AhR agonists, such as TCDD, are known to increase cell number, either by inhibition of apoptosis (not included in the figure) or possibly by enhanced proliferation due to loss of contact inhibition providing a mechanistic basis for their tumor-promoting effects. AhR ligands may further lead to breakdown of E-cadherin function by regulating several key players of EMT, thereby driving the process of tumor progression. Taken from Dietrich and Kaina (2010)

Recent work (Dietrich and Kaina 2010) suggest that the activation of the AhR may lead to deregulation of cell-cell contact, leading to uncontrolled cell division and dedifferentiation as well as to an enhanced cell motility (Figure 4-20). For example, the AhR protein may also bind to the JunD transcription factor, which may then lead to tumor promotion. However, it is not clear whether this is the pathway by which hydrocarbons and dioxins cause cancer *in vivo*.

Dioxins have also been connected to endocrine effects (see before, Mocarelli et al. 2008, 2011), like delaying the onset of puberty (Jacobson-Dickman and Lee, 2009). Again, this is considered to be a consequence of AhR activation (Swendenborg et al. 2012). On the other hand, none of the dioxins show up in tests that check for endocrine disruption. Explaining how dioxins and PCBs are linked to the endocrine system will therefore be a question that remains to be solved in the coming years.

4.5 Read more?

Aguilar, A., Borrell, A. (1994). Abnormally high polychlorinated biphenyl levels in striped dolphins (*Stenella coeruleoalba*) affected by the 1990–1992 Mediterranean epizootic. *Science of the Total Environment*, 154(2), 237–247.

Alexander, M. (1985). Biodegradation of organic chemicals. *Environmental science & technology*, 19(2), 106–111.

Brown, A.J. (2007). Pesticide Exposure Linked to Asthma, *Scientific American*, September 17, 2007.

Auffret, M., Duchemin, M., Rousseau, S., Boutet, I., Tanguy, A., Moraga, D., & Marhic, A. (2004). Monitoring of immunotoxic responses in oysters reared in areas contaminated by the “Erika” oil spill. *Aquatic Living Resources*, 17(3), 297–302.

Baird, R.W. (2001). Status of harbour seals, *Phoca vitulina*, in Canada. *Canadian Field-Naturalist*, 115(4), 663–675.

Besselink, H.T., Van Beusekom, S., Roex, E., Vethaak, A.D., Koeman, J.H., & Brouwer, A. (1996). Low hepatic 7-ethoxyresorufin-O-deethylase (EROD) activity and minor alterations in retinoid and thyroid hormone levels in flounder (*Platichthys flesus*) exposed to the polychlorinated biphenyl (PCB) mixture, Clophen A50. *Environmental Pollution*, 92(3), 267–274.

As a leading technology company in the field of geophysical science, PGS can offer exciting opportunities in offshore seismic exploration.

We are looking for new BSc, MSc and PhD graduates with Geoscience, engineering and other numerate backgrounds to join us.

To learn more our career opportunities, please visit www.pgs.com/careers

A Clearer Image
www.pgs.com



- Biagianti-Risbourg S., Pairault C., Vernet G. & Boulekbache H. (1996). Effect of lindane on the ultrastructure of the liver of the rainbow trout, *Oncorhynchus mykiss*, sac-fry. *Chemosphere* 33, 2065–2079.
- Bignert, A., Olsson, M., Bergqvist, P.A., Bergek, S., Rappe, C., De Wit, C., & Jansson, B. (1989). Polychlorinated dibenzo-p-dioxins (PCDD) and dibenzo-furans (PCDF) in seal blubber. *Chemosphere*, 19(1), 551–556.
- Bijoy Nandan S., Nimila P.J. (2012) Lindane toxicity: Histopathological, behavioural and biochemical changes in *Etroplus maculatus* (Bloch, 1795). *Marine Environmental Research* 76, 63–70.
- Borgå, K., Gabrielsen, G. W., & Skaare, J.U. (2001). Biomagnification of organochlorines along a Barents Sea food chain. *Environmental pollution*, 113(2), 187.
- Coates, J.D., Anderson, R.T., & Lovley, D.R. (1996). Oxidation of polycyclic aromatic hydrocarbons under sulfate-reducing conditions. *Applied and Environmental Microbiology*, 62(3), 1099–1101.
- Davis, B., D.S. Etkin, M. Landry, and K. Watts. 2004. Determination of oil persistence: A historical perspective. Proceedings of the Fifth Biennial Freshwater Spills Symposium Oxidation of polycyclic aromatic hydrocarbons under sulfate-reducing conditions.
- Dietrich, C., & Kaina, B. (2010). The aryl hydrocarbon receptor (AhR) in the regulation of cell–cell contact and tumor growth. *Carcinogenesis*, 31(8), 1319–1328.
- Eskenazi, B., Chevrier, J., Rosas, L. G., Anderson, H.A., Bornman, M.S., Bouwman, H.,... & Stapleton, D. (2009). The Pine River statement: human health consequences of DDT use. *Environmental Health Perspectives*, 117(9), 1359.
- Flouriou, G., Pakdel, F., Ducouret, B., & Valotaire, Y. (1995). Influence of xenobiotics on rainbow trout liver estrogen receptor and vitellogenin gene expression. *Journal of Molecular Endocrinology*, 15(2), 143–151.
- Gao, J., Ellis, L.B., & Wackett, L.P. (2010). The University of Minnesota biocatalysis/biodegradation database: improving public access. *Nucleic acids research*, 38 (suppl 1), D488–D491.
- Gasiewicz, T.A., Henry, E.C., & Collins, L.L. (2008). Expression and activity of aryl hydrocarbon receptors in development and cancer. *Critical reviews in eukaryotic gene expression*, 18(4), 279.
- Gundlach, E.R., & Hayes, M.O. (1978). Vulnerability of coastal environments to oil spill impacts. *Marine Technology Society Journal*, 12(4), 18–27.
- Guzmán, H.M., & Holst, I. (1993). Effects of chronic oil-sediment pollution on the reproduction of the Caribbean reef coral *Siderastrea siderea*. *Marine Pollution Bulletin*, 26(5), 276–282.

Hannam, M.L., Bamber, S. D., Moody, J.A., Galloway, T.S., & Jones, M.B. (2009). Immune function in the Arctic Scallop, *Chlamys islandica*, following dispersed oil exposure. *Aquatic Toxicology*, 92(3), 187–194.

Hatzinger, P.B., & Alexander, M. (1995). Effect of aging of chemicals in soil on their biodegradability and extractability. *Environmental science & technology*, 29(2), 537–545.

Helander, B., Olsson, A., Bignert, A., Asplund, L., & Litzén, K. (2002). The role of DDE, PCB, coplanar PCB and eggshell parameters for reproduction in the white-tailed sea eagle (*Haliaeetus albicilla*) in Sweden. *AMBIO: a Journal of the Human Environment*, 31(5), 386–403.

Hinton, D.E., Klaunig, J.E., & Lipsky, M.M. (1978). PCB-induced alterations in teleost liver: a model for environmental disease in fish. *Mar Fish Rev*, 40, 47–50.

Isobe, T., Oshihoi, T., Hamada, H., Nakayama, K., Yamada, T.K., Tajima, Y,... & Tanabe, S. (2011). Contamination status of POPs and BFRs and relationship with parasitic infection in finless porpoises (*Neophocaena phocaenoides*) from Seto Inland Sea and Omura Bay, Japan. *Marine pollution bulletin*, 63(5), 564–571.

ITOPF(2012) Oil tanker spill statistics 2011, London. 12 p.

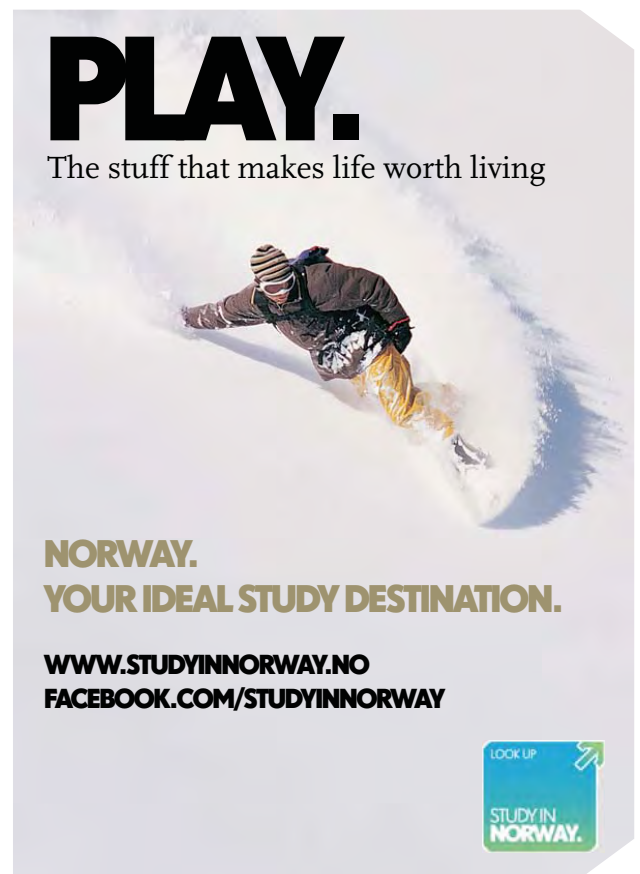
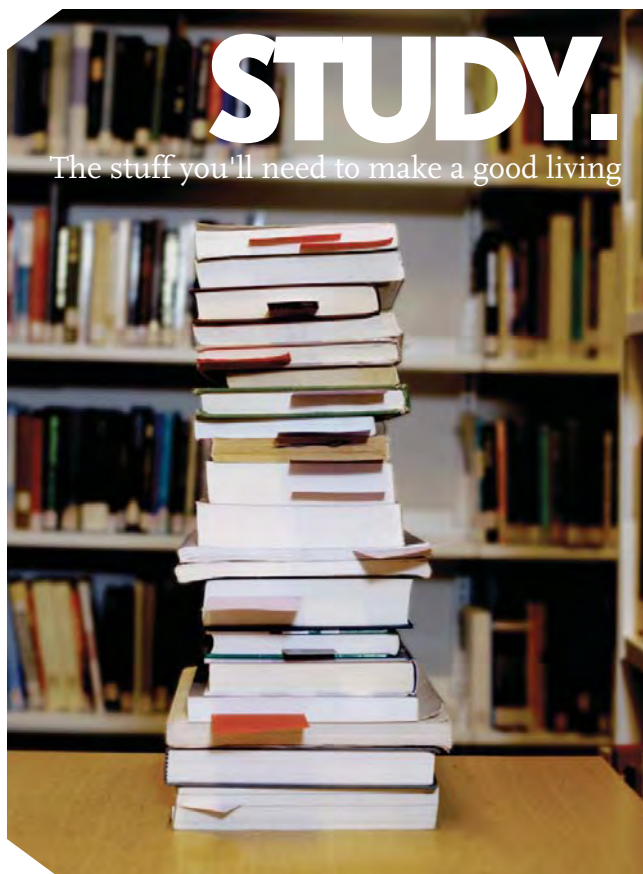

- Jacobson-Dickman, E., & Lee, M.M. (2009). The influence of endocrine disruptors on pubertal timing. *Current Opinion in Endocrinology, Diabetes and Obesity*, 16(1), 25–30.
- Kästner, M., Streibich, S., Beyrer, M., Richnow, H.H., Fritsche, W. (1999) Formation of bound residues during microbial degradation of [¹⁴C]Anthracene in soil. *Appl. Environ. Microbiol.* 65(5), 1834–1842.
- Khan, R.A. (1990). Parasitism in marine fish after chronic exposure to petroleum hydrocarbons in the laboratory and to the Exxon Valdez oil spill. *Bulletin of environmental contamination and toxicology*, 44(5), 759–763.
- Kraugerud, M., Doughty, R.W., Lyche, J.L., Berg, V., Tremoen, N.H., Alestrøm, P., ... & Ropstad, E. (2012). Natural mixtures of persistent organic pollutants (POPs) suppress ovarian follicle development, liver vitellogenin immunostaining and hepatocyte proliferation in female zebrafish (*Danio rerio*). *Aquatic Toxicology*.
- Kuzyk, Z.Z.A., Burgess, N.M., Stow, J.P., & Fox, G.A. (2003). Biological effects of marine PCB contamination on black guillemot nestlings at Saglek, Labrador: liver biomarkers. *Ecotoxicology*, 12(1), 183–197.
- Lahvis, G.P., Wells, R.S., Kuehl, D.W., Stewart, J.L., Rhinehart, H.L., & Via, C.S. (1995). Decreased lymphocyte responses in free-ranging bottlenose dolphins (*Tursiops truncatus*) are associated with increased concentrations of PCBs and DDT in peripheral blood. *Environmental Health Perspectives*, 103(Suppl 4), 67.
- Law, R.J., Barry, J., Barber, J.L., Bersuder, P., Deaville, R., Reid, R.J., ... & Jepson, P.D. (2012). Contaminants in cetaceans from UK waters: Status as assessed within the Cetacean Strandings Investigation Programme from 1990 to 2008. *Marine Pollution Bulletin*.
- Le Roy K.D., Thomas P., Khan I.A. (2006) Thyroid hormone status of Atlantic croaker exposed to Aroclor 1254 and selected PCB congeners, *Comparative Biochemistry and Physiology Part C: Toxicology & Pharmacology* 144, 263–271.
- Lowenstine, L.J. Sick Sea Mammals: A Sign of Sick Seas? (13-Nov-2004).
- Ma, T., Wan, X., Huang, Q., Wang, Z., & Liu, J. (2005). Biomarker responses and reproductive toxicity of the effluent from a Chinese large sewage treatment plant in Japanese medaka (*Oryzias latipes*). *Chemosphere*, 59(2), 281–288.
- Martineau, D., De Guise, S., Fournier, M., Shugart, L., Girard, C., Lagace, A., & Beland, P. (1994). Pathology and toxicology of beluga whales from the St. Lawrence Estuary, Quebec, Canada. Past, present and future. *Science of the Total Environment*, 154(2), 201–215.

- Mihelic, J.R. & Luthy, R.G. (1988). Microbial degradation of acenaphthene and naphthalene under denitrification conditions in soil-water systems. *Applied and Environmental Microbiology* 54, 1188–98.
- Mocarelli, P., Gerthoux, P. M., Needham, L.L., Patterson Jr, D.G., Limonta, G., Falbo, R., ... & Brambilla, P. (2011). Perinatal exposure to low doses of dioxin can permanently impair human semen quality. *Environmental health perspectives*, 119(5), 713.
- Mocarelli, P., Gerthoux, P.M., Patterson Jr, D.G., Milani, S., Limonta, G., Bertona, M., ... & Needham, L. L. (2008). Dioxin exposure, from infancy through puberty, produces endocrine disruption and affects human semen quality. *Environmental health perspectives*, 116(1), 70.
- Monod, G. (1985). Egg mortality of Lake Geneva charr (*Salvelinus alpinus* L.) contaminated by PCB and DDT derivatives. *Bulletin of environmental contamination and toxicology*, 35(1), 531–536.
- Monosson, E., James Fleming, W., & Sullivan, C.V. (1994). Effects of the planar PCB 3, 3', 4, 4'-tetrachlorobiphenyl (TCB) on ovarian development, plasma levels of sex steroid hormones and vitellogenin, and progeny survival in the white perch (*Morone americana*). *Aquatic Toxicology*, 29(1), 1–19.
- Moore, S.F., & Dwyer, R.L. (1974). Effects of oil on marine organisms: a critical assessment of published data. *Water Research*, 8(10), 819–827.
- Mössner S, Ballschmiter K. (1997) Marine mammals as global pollution indicators for organochlorines. *Chemosphere* 34, 1285–1296.
- Mu J.L., Wang X.H., Jin F., Wang J.Y., Hong H.S. (2012) The role of cytochrome P4501A activity inhibition in three- to five-ringed polycyclic aromatic hydrocarbons embryotoxicity of marine medaka (*Oryzias melastigma*). *Marine Pollution Bulletin* 64, 1445–1451.
- Nakayama, K., Sei, N., Handoh, I.C., Shimasaki, Y., Honjo, T., & Oshima, Y. (2011). Effects of polychlorinated biphenyls on liver function and sexual characteristics in Japanese medaka (*Oryzias latipes*). *Marine Pollution Bulletin*, 63(5), 366–369.
- Nam, K., & Alexander, M. (1998). Role of nanoporosity and hydrophobicity in sequestration and bioavailability: tests with model solids. *Environmental science & technology*, 32(1), 71–74.
- Oliva M., Garrido C., Sales D., & González de Canales M.L. (2008). Lindane toxicity on early life stages of gilthead seabream (*Sparus aurata*) with a note on its histopathological manifestations. *Environmental Toxicology and Pharmacology* 25, 94–102.

Orecchio, S., Mannino M.R. (2010) Chemical speciation of polycyclic aromatic hydrocarbons in sediments: Partitioning and extraction of humic substances, *Marine Pollution Bulletin* 60, 1175–1181.

Pesando D., Robert S., Huitorel P., Gutknecht E., Pereira L., Girard J.P., Ciapa B. (2004) Effects of methoxychlor, dieldrin and lindane on sea urchin fertilization and early development. *Aquatic Toxicology* 66, 225–239

Peterson, C.H., Rice, S.D., Short, J.W., Esler, D., Bodkin, J.L., Ballachey, B.E., & Irons, D.B. (2003). Long-term ecosystem response to the Exxon Valdez oil spill. *Science*, 302, 2082–2086.

Philibert, A., Schwartz, H., & Mergler, D. (2009). An exploratory study of diabetes in a First Nation community with respect to serum concentrations of p, p'-DDE and PCBs and fish consumption. *International journal of environmental research and public health*, 6(12), 3179–3189.

Piatt, J.F., Lensink, C.J., Butler, W., Kendziorek, M., & Nysewander, D.R. (1990). Immediate impact of the 'Exxon Valdez' oil spill on marine birds. *The Auk*, 107(2), 387–397.

Nash R.G., Woolson E.H. (1967) *Persistence of chlorinated hydrocarbon insecticides in soils*, American Association for the Advancement of Science.



**Technical training on
WHAT you need, WHEN you need it**

At IDC Technologies we can tailor our technical and engineering training workshops to suit your needs. We have extensive experience in training technical and engineering staff and have trained people in organisations such as General Motors, Shell, Siemens, BHP and Honeywell to name a few.

Our onsite training is cost effective, convenient and completely customisable to the technical and engineering areas you want covered. Our workshops are all comprehensive hands-on learning experiences with ample time given to practical sessions and demonstrations. We communicate well to ensure that workshop content and timing match the knowledge, skills, and abilities of the participants.

We run onsite training all year round and hold the workshops on your premises or a venue of your choice for your convenience.

For a no obligation proposal, contact us today at training@idc-online.com or visit our website for more information: www.idc-online.com/onsite/

OIL & GAS ENGINEERING

ELECTRONICS

AUTOMATION & PROCESS CONTROL

MECHANICAL ENGINEERING

INDUSTRIAL DATA COMMS

ELECTRICAL POWER

Phone: +61 8 9321 1702
Email: training@idc-online.com
Website: www.idc-online.com

IDC TECHNOLOGIES

Ressler, B.P., Kneifel, H., & Winter, J. (1999). Bioavailability of polycyclic aromatic hydrocarbons and formation of humic acid-like residues during bacterial PAH degradation. *Applied Microbiology and Biotechnology*, 53(1), 85–91.

Ribas-Fitó, N., Torrent, M., Carrizo, D., Muñoz-Ortiz, L., Júlvez, J., Grimalt, J.O., & Sunyer, J. (2006). In utero exposure to background concentrations of DDT and cognitive functioning among preschoolers. *American journal of epidemiology*, 164(10), 955–962.

Rogan, W.J., & Chen, A. (2005). Health risks and benefits of bis (4-chlorophenyl)-1, 1, 1-trichloroethane (DDT). *The Lancet*, 366(9487), 763–773.

Sagiv, S.K., Nugent, J.K., Brazelton, T.B., Choi, A.L., Tolbert, P.E., Altshul, L.M., & Korrick, S.A. (2008). Prenatal organochlorine exposure and measures of behavior in infancy using the Neonatal Behavioral Assessment Scale (NBAS). *Environmental health perspectives*, 116(5), 666.

Sari, A.A., Tachibana, S., & Itoh, K. (2012) Determination of co-metabolism for 1,1,1-trichloro-2,2-bis(4-chlorophenyl) ethane (DDT) degradation with enzymes from *Trametes versicolor* U97. *Journal of Bioscience and Bioengineering* 114, 176–181.

Sarkar A., Ray D., Shrivastava A.N., & Sarker S. (2006) Molecular Biomarkers: Their significance and application in marine pollution monitoring. *Ecotoxicology* 15, 333–340.

Schechter, A., Pavuk, M., Constable, J.D., & Pöpke, O. (2002). A follow-up: high level of dioxin contamination in Vietnamese from Agent Orange, three decades after the end of spraying. *Journal of Occupational and Environmental Medicine*, 44(3), 218–220.

Swedenborg, E., Kotka, M., Seifert, M., Kanno, J., Pongratz, I., & Rügge, J. (2012). The aryl hydrocarbon receptor ligands 2, 3, 7, 8-tetrachlorodibenzo-p-dioxin and 3-methylcholanthrene regulate distinct genetic networks. *Molecular and Cellular Endocrinology* 362, 39–47.

Torres-Sánchez, L., Rothenberg, S. J., Schnaas, L., Cebrián, M.E., Osorio, E., del Carmen Hernández, M., ... & López-Carrillo, L. (2007). In utero p, p'-DDE exposure and infant neurodevelopment: a perinatal cohort in Mexico. *Environmental health perspectives*, 115(3), 435–439.

Van den Berg, M., Birnbaum, L.S., Denison, M., De Vito, M., Farland, W., Feeley, M., ... & Peterson, R.E. (2006). The 2005 World Health Organization reevaluation of human and mammalian toxic equivalency factors for dioxins and dioxin-like compounds. *Toxicological Sciences*, 93(2), 223–241.

van Wendel de Joode, B., Wesseling, C., Kromhout, H., Monge, P., Garcia, M., & Mergler, D. (2001). Chronic nervous-system effects of long-term occupational exposure to DDT. *The Lancet*, 357(9261), 1014–1016.

Vuorinen, P.J., Keinänen, M., Paasivirta, J., & Koistinen, J. (1998). Dioxin-Like Organochlorines in the M74 Syndrome of Baltic Salmon (*Salmo salar* L.). *Marine Environmental Research*, 46(1), 177–177.

Vuorinen, P.J., Parmanne, R., Vartiainen, T., Keinänen, M., Kiviranta, H., Kotovuori, O., & Halling, F. (2002). PCDD, PCDF, PCB and thiamine in Baltic herring (*Clupea harengus* L.) and sprat [*Sprattus sprattus* (L.)] as a background to the M74 syndrome of Baltic salmon (*Salmo salar* L.). *ICES Journal of Marine Science: Journal du Conseil*, 59(3), 480–496.

Wootton, E.C., Dyrzynda, E.A., & Ratcliffe, N.A. (2003). Bivalve immunity: comparisons between the marine mussel (*Mytilus edulis*), the edible cockle (*Cerastoderma edule*) and the razor-shell (*Ensis siliqua*). *Fish & shellfish immunology*, 15(3), 195–210.

Zhang, Q., Yang, L., & Wang, W.X. (2011). Bioaccumulation and trophic transfer of dioxins in marine copepods and fish. *Environmental Pollution*, 159(12), 3390–3397.

Zhang, W.X., Bouwer, E.J., & Ball, W.P. (1998). Bioavailability of Hydrophobic Organic Contaminants: Effects and Implications of Sorption-Related Mass Transfer on Bioremediation. *Ground Water Monitoring & Remediation*, 18(1), 126–138.

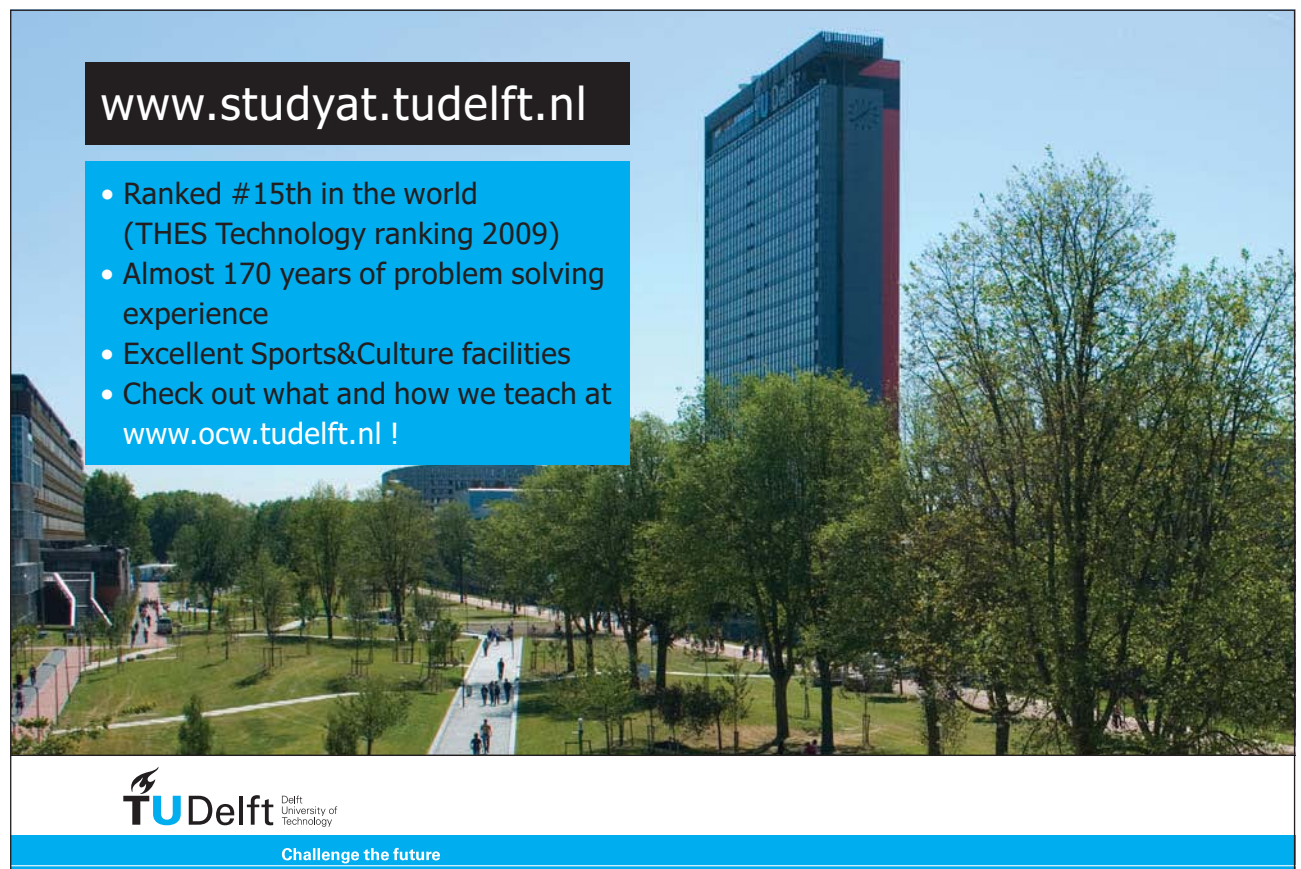

www.studyat.tudelft.nl

- Ranked #15th in the world (THES Technology ranking 2009)
- Almost 170 years of problem solving experience
- Excellent Sports&Culture facilities
- Check out what and how we teach at www.ocw.tudelft.nl !

TU Delft Delft University of Technology
Challenge the future



5 Newer forms of pollution

5.1 Plastics

It was Captain Charles J. Moore¹⁰, on his way home after a sailing race, who made the distasteful discovery in 1997: an enormous stretch of floating debris, quickly christened “The Eastern Garbage Patch” or “Great Pacific Garbage Patch”, to be found within the North Pacific Subtropical High, an area between Hawaii and California.

Not that this was the first time anyone came across large zones filled with plastic debris. The Great Pacific Garbage Patch is indeed not the only one of its kind. A similar floating waste collection can be found in the Atlantic Ocean, and another (the Western Pacific Patch) can be found south of the Kuroshio current, off the coast of Japan (NOAA, <http://marinedebris.noaa.gov/info/pdf/patch.pdf>).

The exact size of the patches is unknown, as most debris isn't anything but small plastic particles in suspension in the water, impossible to detect by aircraft, satellite or visual inspection from the deck of a passing ship. The only way to determine the location of the boundaries of the patch is direct sampling of the water. Nevertheless, its size is estimated to be somewhere between 700,000 and 15,000,000 km². Charles Moore has estimated the mass of the Great Pacific Garbage Patch at 100 million tons. Compare this with the estimate of 5 to 10 billion tonnes C found in the oceans' animal and plant biomass (Groombridge and Jenkins 2000): 1–2% of that mass is now present as plastic, in one patch only...

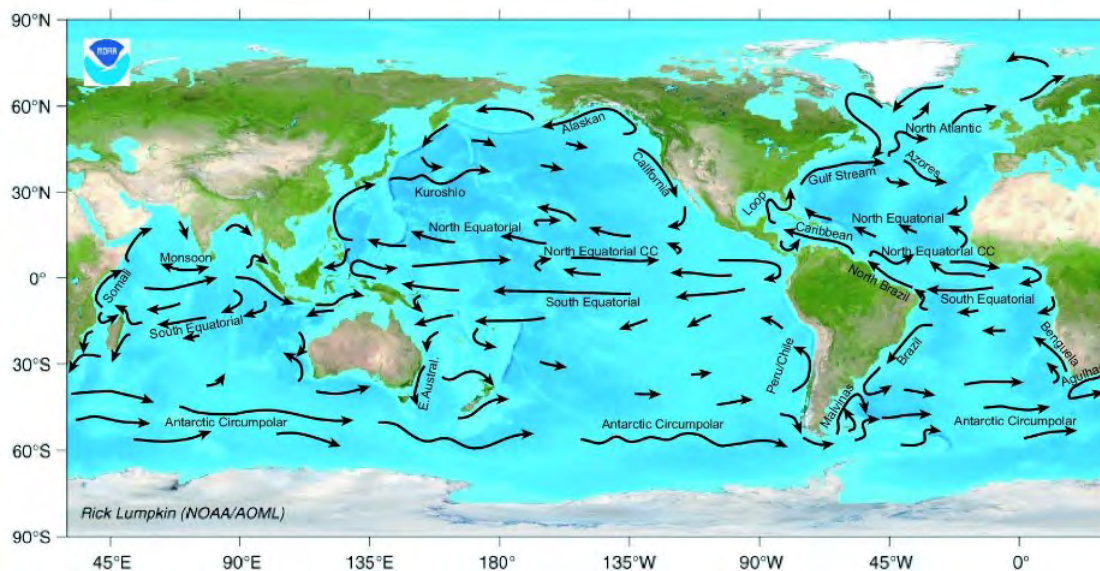

Figure 5-1. Ocean surface currents.
Source: NOAA, USA.

5.1.1 Origin of the plastic

The plastic debris originates from a wide and diverse range of sources, both on land and on ships on the sea. Once the plastic has floated into the sea, it becomes the toy of the oceanic currents (Figure 5-1; Figure 5-2). The Great Pacific Garbage Patch is for example located within the North Pacific Gyre.

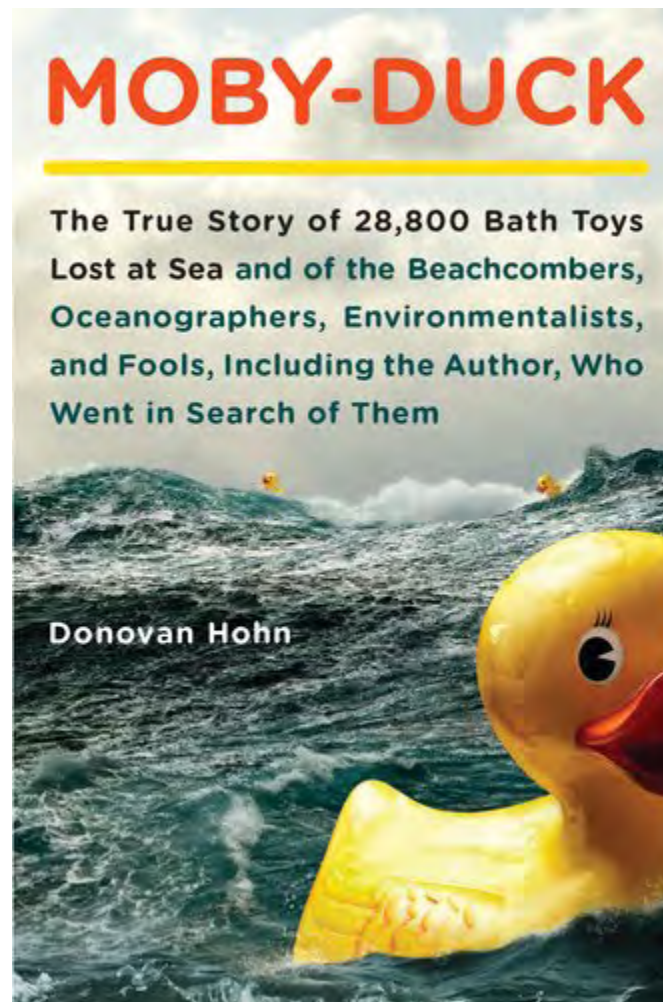

Figure 5-2. 28,800 Friendly Floatees lost at sea.

Tens of thousands rubber duckies were thrown overboard from a container ship in the Pacific Ocean on 10 January 1992. They washed ashore on beaches around the world and helped oceanographers to trace the ocean currents (Hohn, 2011).

Land-based sources include the following:

- **Storm water discharges:** when storm weather and heavy rains strain the proper working of sewage treatment plants, a part of the water can flow out of the plant, and be discharged directly in the rivers or the sea. Plastic objects can be dragged along. This waste can include rubbish such as condoms, tampon applicators, syringes and street litter. It is probably the major land-based source of plastic marine debris in the USA.

- **Littering** by beachgoers and tourists. Beachgoers may carelessly leave litter at the coast and this will become marine debris. Items such as food packaging and beverage containers, cigarette butts and plastic beach toys. Fishermen may leave behind fishing gear. Litter from zones more inland can reach the sea when it ends up in rivers and streams.
- **Industrial activities** may result in marine debris if they are improperly disposed of on land or if they are lost during transport or loading/unloading at a port.

Ships may contribute to the plastic debris in the oceans by littering, either by accident or on purpose (and then illegitimately so, given the new regulations in MARPOL Annex VI dd. 1 January 2013). Ocean-based sources of marine debris typically include:

- Commercial **fishing gear** like nets, lines and ropes, strapping bands, bait boxes and bags, gillnet or trawl floats
- Galley **waste** and household trash
- **Material lost or thrown overboard** from merchant, military and research vessels. Offshore platforms typically lose: hard hats, gloves, storage drums, survey material,...



"I studied English for 16 years but...
...I finally learned to speak it in just six lessons"

Jane, Chinese architect

ENGLISH OUT THERE

Click to hear me talking before and after my unique course download

A typical example of plastic debris are the resin pellets that are used as basis for the production of plastic end products, the so-called nurdles (Figure 5-3). They have a diameter of 2–6 mm, and are easily spilt during production and handling. They have been found in most oceans, even in non-industrialised areas such as Tonga or Fiji. They are also readily ingested by marine organisms, thereby entering the food chain.



Figure 5-3. Nurdles.

Source: gentlemanrook, Flickr/Wikimedia

Plastics are being used because they are light while at the same time stable and resistant to degradation. These properties are at the same time the core of the problem we have with plastic waste. Plastic has a high level of persistence in the environment, and while sunlight (especially the UV-B component) and salt are able to weather the material, all they do is break the plastic up into smaller and smaller pieces. These particles have been found suspended in seawater, in the sediments on the bottom of the sea, and even inside marine organisms. Pieces as small as 2 μm have been reported and the abundance of such fragments has increased significantly over the last 40 years. Moreover, they are able to adsorb apolar organic materials such as polyaromatic and polychlorinated hydrocarbons. If (or rather, when) the plastic particles end up in the food chain, so will these pollutants. With all due effect on the organisms that ate them (Figure 5-4).



Figure 5-4. Albatros remains.
Source: Forest and Kim Starr, USGS.

5.1.2 Facts & Figures

- Every year, we produce about 265 million ton of plastic worldwide (and 57 million ton in the European Union alone – Figure 5-5).

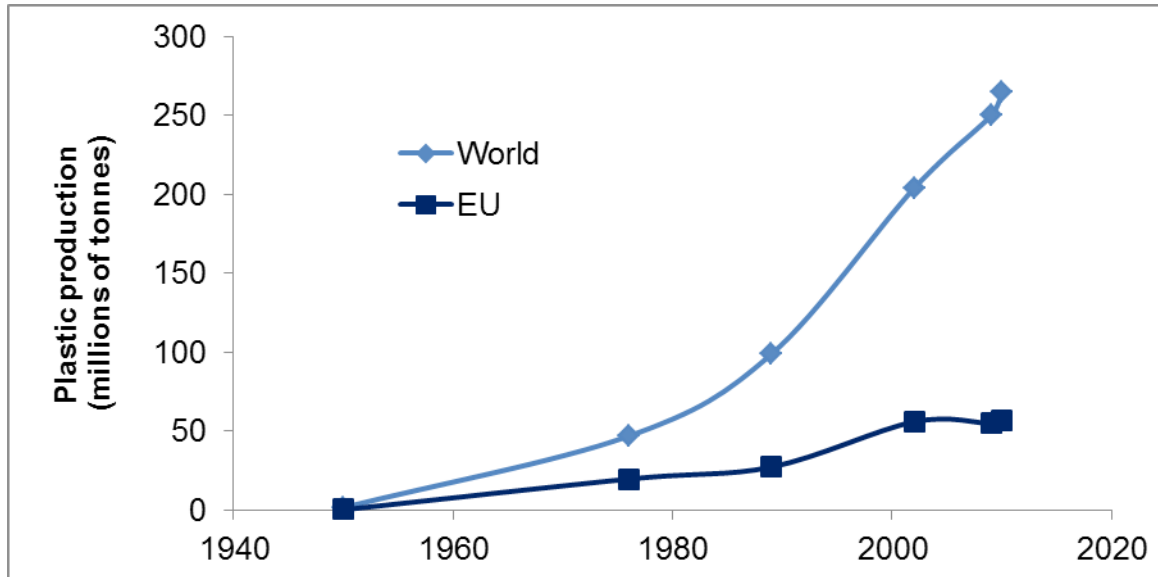

Figure 5-5. Plastic production worldwide and in the European Union.

- Approx. 80% of marine litter is land-based.
- According to the UN, we dump 6.4 million tons of waste into the oceans every year, 60–80% of which consists of plastic.
- 1 kg out of every 5 kg wasted plastic ends up in oceans.

- In 2004, seawater samples contained 6 times more plastic than plankton (source: Algalita)
- Samples of strandline material contain more than 10% plastic per weight. The fragments will increase with production. (source: KIMO)
- Every year, 800 000 tons of single use plastic bags are given out in the European Union alone (EU 6864/11).
- In 2006, 19.7% of all plastic waste in the European Union was recycled, 30.3% was combusted for energy reclamation, and the remainder (11.5 million ton) was dumped.
- Biodegradation of plastics takes centuries (Table 51).

5.1.3 Consequences for marine life

First and foremost, the plastic can affect the feeding of many creatures living in the oceans. Marine animals often mistake the floating debris for prey. A plastic bag resembles a nutritious jellyfish in the eyes of a sea turtle. Seagulls swoop down to catch a fish and end up with a plastic bottle cap in their stomach (Figure 5-4). And according to Capt. Moore, who discovered the patches, the brown-coloured plastic parts were being harvested selectively – as this resembles best normal fish food. But the cooperation of the animal is not always needed: plastic that sinks to the bottom of the ocean can cover the benthic fauna (corals, sea anemones,...) and flora (macrophytes), limiting their ability to feed or photosynthesise.

Study at one of Europe's leading universities



DTU, Technical University of Denmark, is ranked as one of the best technical universities in Europe, and offers internationally recognised Master of Science degrees in 39 English-taught programmes.

DTU offers a unique environment where students have hands-on access to cutting edge facilities and work

closely under the expert supervision of top international researchers.

DTU's central campus is located just north of Copenhagen and life at the University is engaging and vibrant. At DTU, we ensure that your goals and ambitions are met. Tuition is free for EU/EEA citizens.

Visit us at www.dtu.dk



Secondly, there are chemical risks inherent to the plastic soup as well. Toxic additives used in plastic manufacturing (such as bisphenol A or phthalates, both suspected pseudohormones) can start to leach into the water. Due to the hydrophobic nature of most plastics, the debris adsorbs (and concentrates) a large quantity of organic pollutants already present in the water: hydrocarbons, PAH, pseudohormones, ... If this plastic later on enters the food chain, it adds to the problem of biomagnification and bioaccumulation of these toxic compounds. It has been shown that filter feeders like *Mytilus edulis* and *Arenicola marina* take up microplastic particles smaller than 10 µm. Such particles are also found in the stomach of gastropods and fish, which prey on these filter feeders, and even in several marine mammals and birds (which prey on the fish).

This combined with the fact that the plastic will break down slowly into microparticles, which can be easily taken up by marine biota, suggests that the impact of the plastic debris may be much worse than is currently suspected.

How Long does it take to Decompose...	
Paper Towel	2–4 weeks
Banana Peel	3–4 weeks
Paper Bag	1 month
Newspaper	1.5 months
Apple Core	2 months
Cardboard	2 months
Cotton Glove	3 months
Orange peels	6 months
Plywood	1–3 years
Wool Sock	1–5 years
Milk Cartons	5 years
Cigarette Butts	12 years
Leather shoes	40 years
Tinned Steel Can	50 years
Foamed Plastic Cups	50 years
Rubber Boot Sole	50–80 years
Plastic containers	80 years
Aluminum Can	500 years
Plastic Bottles	450 years
Disposable Diapers	550 years
Monofilament Fishing Line	600 years
Plastic Bags	200–1000 years

Table 5-1. Biodegradation time for frequently used objects.

As biodegradation takes centuries, and as no one wants to bear the huge costs for plastic reclamation (so far), it should be clear that prevention of too much plastic waste offers the best options to avoid more waste accumulation in the oceans.



Figure 5-6. Macroplastic waste in the sea.
Top: Source: NOAA Farallones Marine Sanctuary Association
Bottom: Mariana islands, Guam. Source: David Burdick, NOAA

5.2 Noise pollution: the death of a thousand cuts

One of the less known forms of pollution, but nevertheless one that has a serious impact on the marine, does not involve the presence of a harmful chemical substance, but is caused by underwater noise. More and more economic activities are being deployed in the oceans: shipping, oil drilling, scientific research, construction work under water (drilling platforms, wind mills,...), sonar-enhanced fishing,... On the whole, the average noise level under water has doubled every decade for the past fifty to sixty years. thanks to anthropogenic noise.

The impact of this noise is enormous, especially among the marine mammals. They change their behaviour and are unable to communicate as they used to, they are visibly stressed and suffer from a weakened immune system, and their auditory system gets damaged. And from time to time, the noise drives a number of whale species to throw themselves on the beaches.

5.2.1 Measuring noise levels

Sound consists of traveling longitudinal vibrations which travel through a medium like water or air. They are described by essentially three parameters (Figure 5-7): their pitch (or wave frequency), their velocity in the medium and their intensity (amplitude). Pitch can also be expressed as a function of the wavelength of the vibration, with the mathematical relation between frequency (ν , the Greek letter nu) and wavelength (λ , the Greek letter lambda) depending on the wave velocity v as follows:



MSM
MAASTRICHT SCHOOL OF MANAGEMENT

Increase your impact with MSM Executive Education

For almost 60 years Maastricht School of Management has been enhancing the management capacity of professionals and organizations around the world through state-of-the-art management education.

Our broad range of Open Enrollment Executive Programs offers you a unique interactive, stimulating and multicultural learning experience.

Be prepared for tomorrow's management challenges and apply today.

For more information, visit www.msm.nl or contact us at +31 43 38 70 808 or via admissions@msm.nl

the globally networked management school

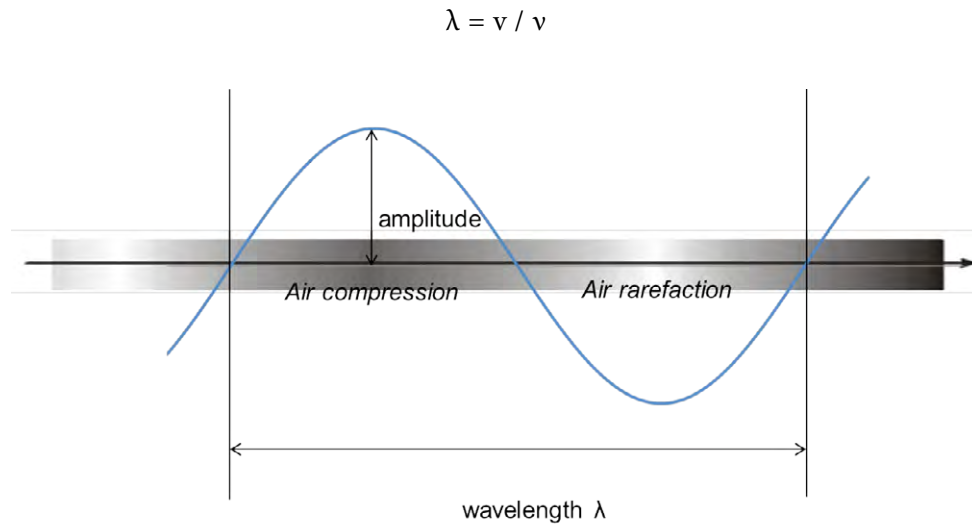

Figure 5-7. A travelling sound wave has amplitude and pitch.

When the sound lasts only for a short burst, it is called a pulse. Pulses typically consist of a broad range of frequencies. The opposite is a tone. Tones are sounds with one specific frequency, lasting for a substantial time.

Physically, the wave consists of (air/water) molecules that vibrate around their location, and drag along the neighbouring particles. On the molecular scale, they pass on the wave energy from particle to particle as such. On a larger scale, they cause small pockets where there are more molecules (enforcing local compression of the medium) and pockets where there are less (leading to local rarefaction of the medium) (Figure 5-8). This leads to macroscopically appreciable variations in air pressure.

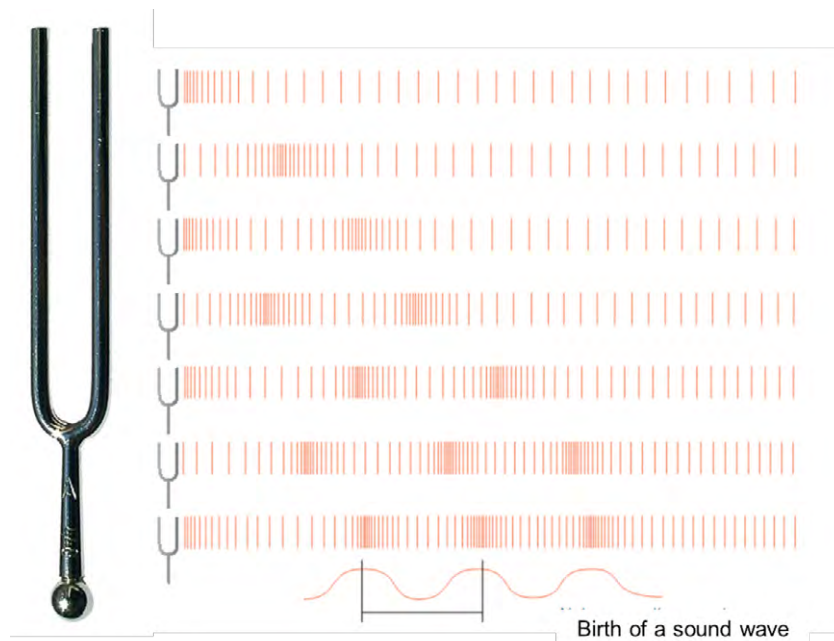

Figure 5-8. Propagation of a sound wave. This causes the occurrence of local pockets of compression and rarefaction.

The amplitude of the wave is a measure for the amount of wave energy that is being displaced along the wave. As it describes local variations in pressure, it can be expressed in the S.I.-unit for pressure: the pascal. Note that, while the average air pressure lies around a value of 103.5 kPa, the mammalian ear is usually capable of detecting variations of not more than 20 micropascal – five billion times smaller.

Another way to express the intensity of a wave, is by expressing its energy per unit of area and per second (in watts per m²). To explain this, we take first the sound pressure defined as

$$p = v \cdot \lambda \cdot \rho \cdot u$$

where ρ is the density of the medium, v again the frequency of the wave and λ its wavelength, while u refers to the motion of molecules in the medium due to the sound

If the root mean square is taken of p (defined for each individual molecule contributing to the sound)

$$q = \text{RMS}(p) = \sqrt{\frac{\sum p_i^2}{n}}$$

the sound wave intensity becomes

$$I = q^2 / v \cdot \lambda \cdot \rho$$

When a wave is propagated, its total energy content is taken to remain constant. However, when we consider a point source (eg an explosion or a sonar device), such as in Figure 5-9, it becomes clear that the farther away a wave has travelled from its point of origin, the lower its energy per unit of area becomes.

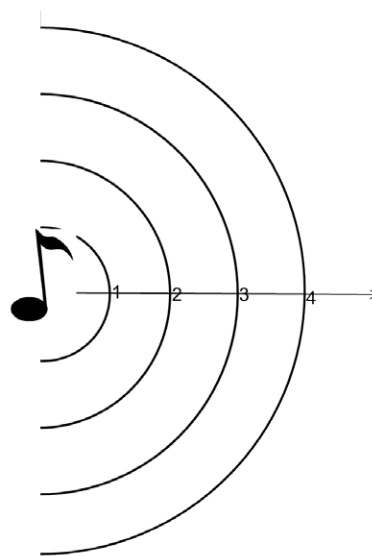

Figure 5-9. Dispersion of the wave energy from a point source

$v \cdot \lambda \cdot \rho$ is furthermore defined as the characteristic acoustical impedance Z_0 (in Pa.s/m), or

$$Z_0 = p^2/I$$

or

$$I = p^2/ Z_0$$

Note that the intensity I turns out to be proportional to the square of the pressure of the sound waves.

Medium	Density ρ in kg/m ³ at 20 °C	Speed of sound c in m/s at 20 °C	Acoustic impedance Z_0 in Pa.s/m
Air	1.204	343	413.5
Water	1,000	1,440	1,440,000
Brick	1,700	4,300	7,310,000
Glass quartz	2,200	5,500	12,100,000
Aluminium	2,700	6,100	16,500,000
Steel	7,500	6,000	45,000,000

Table 5-2. Density of the Medium, Speed of sound, and acoustic impedance

gaiteye
Challenge the way we run

EXPERIENCE THE POWER OF FULL ENGAGEMENT...

**RUN FASTER.
RUN LONGER..
RUN EASIER...**

**READ MORE & PRE-ORDER TODAY
WWW.GAITEYE.COM**



As such, one can calculate the characteristic impedance of air at room temperature to be about 420 Pa·s/m. The impedance of water, however, is about 1.5 MPa·s/m, which is 3400 times higher (Table 5-2). This means that a sound in water with a given amplitude is 3500 times less intense than a similar one in air. This is because the air, with its lower z , moves with a much greater velocity and displacement amplitude than does water.

Upon transition from water to air, part of the sound wave will reflect and part will be transmitted to the air.

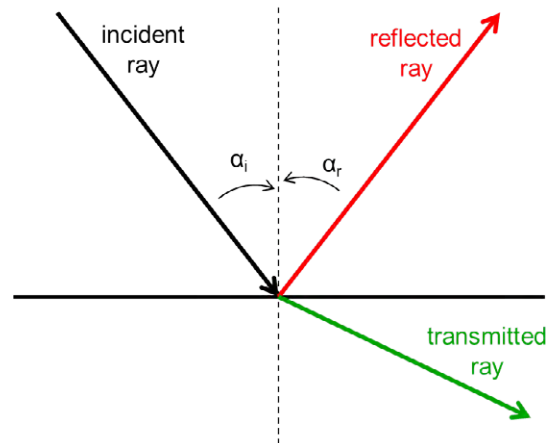

Figure 5-10. Impedance and wave reflection at the water-air boundary

This reflection, defined as

$$R = \frac{I_{\text{reflected}}}{I_{\text{incident}}}$$

depends upon the angle α (angle between the direction of the sound wave and the normal on the boundary plane) and on the acoustical impedances of water and air. Simplifying matters, for waves which are propagated perpendicularly to the boundary, the reflection coefficient becomes:

$$R = \frac{Z_2 - Z_1}{Z_2 + Z_1}$$

Some typical examples of the reflection coefficient in salt water for different materials have been given in Table 5-3.

For the transition from seawater to air, the reflectance is nearly complete. Less than one thousandth of the sound gets transmitted (or there is a loss of sound intensity of at least 30 dB as calculated below). Without this sea-air boundary, sailors would hear the underwater sounds as they are heard by the marine life forms. Now, underwater sounds are muffled. It is therefore not surprising that noise pollution has not become a more pressing issue much sooner. No one literally heard (about) it....

Material	Impedance	R
Air	415	-1
Fresh water	1 480 000	0.04
Salt water	1 540 000	0
Wet fish flesh	1 600 000	0.02
Wet fish bone	2 500 000	0.24
Rubber	1 810 000	0.08
Granite	16 000 000	0.82
Quartz	15 300 000	0.81
Clay	7 700 000	0.67
Sandstone	7 700 000	0.66
Concrete	8 000 000	0.68
Steel	47 000 000	0.94
Brass	40 000 000	0.92
Aluminium	17 000 000	0.83

Table 5-3. Sound wave reflection coefficients (with respect to seawater).

Source: <http://www.sal2000.com/ds/ds3/Acoustics/Wave%20Reflection.htm>

Lastly, we need to introduce a very practical unit. The range of intensities that can be dealt with by the average mammalian ear is so large, that scientists have chosen to use a **logarithmic** scale to express sound intensity (sound pressure level, SPL).

$$\text{SPL} = 10 \cdot \log_{10}(I/I_0)^2 = 10 \cdot \log_{10}(p/p_0)^2 = 20 \cdot \log_{10}(p/p_0)$$

which is then expressed in dB (decibel). In this equation, p stands for the actual pressure variation introduced by the sound wave, and p_0 for a reference pressure value. For sounds transmitted in air, the threshold of human hearing, 20 μPa , has been chosen as reference pressure. This equals the sound of a mosquito at 3 m away. For underwater sounds, however, everything is compared to $p_0 = 1 \mu\text{Pa}$. The SPL is then expressed in "dB re 1 μPa " to indicate the difference in scale.

5.2.2 Sources of sound in the ocean

Want to experience the sounds of the ocean yourself?
Check out: <http://www.dosits.org/audio/interactive/>

Part of the noise in the ocean comes from **natural physical sources**. The largest part of what can be considered ambient noise or background noise is caused by the wind blowing over the water. This produces sounds all the way between 1 Hz and 100 kHz. Below 10 Hz, this effect is mainly due to the existence of waves; higher sounds are mostly due to the oscillations of bubbles in the water. Precipitation is a second source of noise. It can raise the background with about 30 dB between 100 and 20,000 Hz. Thunder and lightning raises the background level as well, with around 15 Hz, even at 5 km distance. Lastly, there are seismic eruptions which add up to 40 dB.

Ice packs on the other hand minimise the interaction between wind and water, and therefore reduce sound levels in the ocean with 10–20 dB. Cracks in the ice, however, can produce sound pulses of around 30 dB.

A second group of sounds are those produced by the **organisms in the sea**. Many marine mammals (such as dolphins and whales) produce sounds, which altogether range from less than 10 Hz to over 100,000 Hz. In addition there are also a number of fish and even invertebrates which produce sounds (Table 54).

DESTINATIONS	GATE	ARRIVAL
INDUSTRY IMPACT	OW	FASTER
GLOBAL ASSIGNMENTS	OW	FASTER
SENIOR CLIENT CONTACT	OW	FASTER
CAREER DEVELOPMENT	OW	FASTER
MAKE PARTNER	OW	FASTER

 OLIVER WYMAN



Oliver Wyman is a leading global management consulting firm that combines deep industry knowledge with specialized expertise in strategy, operations, risk management, organizational transformation, and leadership development. With offices in 50+ cities across 25 countries, Oliver Wyman works with the CEOs and executive teams of Global 1000 companies.
An equal opportunity employer.

GET THERE FASTER

Some people know precisely where they want to go. Others seek the adventure of discovering uncharted territory. Whatever you want your professional journey to be, you'll find what you're looking for at Oliver Wyman.

Discover the world of Oliver Wyman at oliverwyman.com/careers

 MARSH & MCLENNAN
COMPANIES



Click on the ad to read more

Source	Broadband Source Level (underwater dB at 1 m)
Sperm Whale Clicks	163–236
Beluga Whale Echolocation Click	206–225 (peak-to-peak)
White-beaked Dolphin Echolocation Clicks	194–219 (peak-to-peak)
Spinner Dolphin Pulse Bursts	108–115
Bottlenose Dolphin Whistles	125–173
Fin Whale Moans	155–186
Blue Whale Moans	155–188
Grey Whale Moans	142–185
Bowhead Whale Tonals, Moans and Song	128–189
Humpback Whale Song	144–174
Humpback Whale Fluke and Flipper Slap	183–192
Southern Right Whale Pulsive Call	172–187
Snapping Shrimp	183–189 (peak-to-peak)

Table 5-4. Sounds from marine organisms.

(Source: <http://www.dosits.org/science/soundsinthesea/commonsounds/>)

Lastly, there is a large group of anthropogenic sounds to be heard under water.

Commercial shipping is undoubtedly the most important source of low-frequency background noise in the oceans. For starters, there are in the commercial fleet alone around 79 074 vessels (according to Equasis in 2012), which can be classified according to Table 5-5), not counting the 21 589 fishing vessels (IMO, 2012). The noise from these ships originates from propellers, machinery, the hulls passage through the water and the increasing use of sonar and depth sounders (Gordon and Moscrop 1996, Perry 1998, Simmonds et al. 2004).

Ship Type	Small (GT<500)	Medium (500≤GT<25.000)	Large (25.000≤GT<60.000)	Very large (GT≥60.000)	Total
General Cargo Ship	4627	12210	197		17034
Specialised Cargo Ship	14	188	48		250
Container Ship	16	2411	1679	868	4974
Ro-Ro Cargo Ship	32	774	587	144	1537
Bulk Carrier	362	3647	4215	1373	9597
Oil/Chemical Tanker	1852	6373	2255	1348	11828
Gas Tanker	44	1014	187	329	1574
Other Tankers	259	402	5		666
Passenger Ships	3461	2505	269	135	6370
Offshore Vessels	2185	4312	75	120	6692
Service Ships	2196	2219	23	4	4442
Tugs	13238	872			14110

Table 5-5. Distribution of commercial ships according to their type and size in 2011

(according to Equasis, 2012). GT = Gross tonnage and is expressed in tonnes.

SONAR (an acronym for **SO**und **N**avigation **A**nd **R**anging) are a second important source of anthropogenic sound in the oceans. A part of them is needed to tackle scientific research, a part is used for military purposes, and the rest has a commercial use. In addition, there is a distinction between passive and active use of sonar: *passive* sonar is essentially listening for the sound made by vessels; *active* sonar is emitting pulses of sounds and listening for echoes. Scientific usage comprises detection of fish and estimation of their biomass, assessment of the ocean bottom (composition and topography), wave measurements and water velocity measurements.

Military sonars are used for target detection and localisation. They work at broader ranges and higher levels than civilian equipment. Low-frequency sonars (up to 1 kHz) are used for broad surveillance applications. They have an output of around 215 dB re 1 μ Pa per sonar projector, which are then used in arrays of different projectors together. Mid-frequency sonars (1–20 kHz) are meant for submarine detection, depth sounding and weapon activation. Lastly, there us the group of the high-frequency sonars (up to 100 kHz). These are meant for mine localisation, seafloor mapping and torpedo guidance.

Type of	Frequency (kHz)	Source level (dB re 1 μ Pa)
650cc Jetski	0.8–50.0	75-125
Rigid inflatable	6.3	152
7m outboard motor boat	0.63	156
Fishing boat	0.25–1.0	151
Fishing trawler	0.1	158
Tug pulling empty barge	0.037	166
	1.0	164
	5.0	145
Tug pulling loaded barge	1.0	170
	5.0	161
34m (twin diesel engine) workboat	0.63	159
Tanker (135m)	0.43	169
Tanker (179m)	0.06	180
Supertanker (266m)	0.008	187
Supertanker (340m)	0.007	190
Supertanker (337m)	0.033	185
Container ship (219m)	0.033	181
Container ship (274m)	0.008	181
Freighter (135m)	0.041	172

Table 56. Summary of sound frequencies produced by shipping traffic and their source levels.

Source: Simmonds et al. 2004 and references cited therein

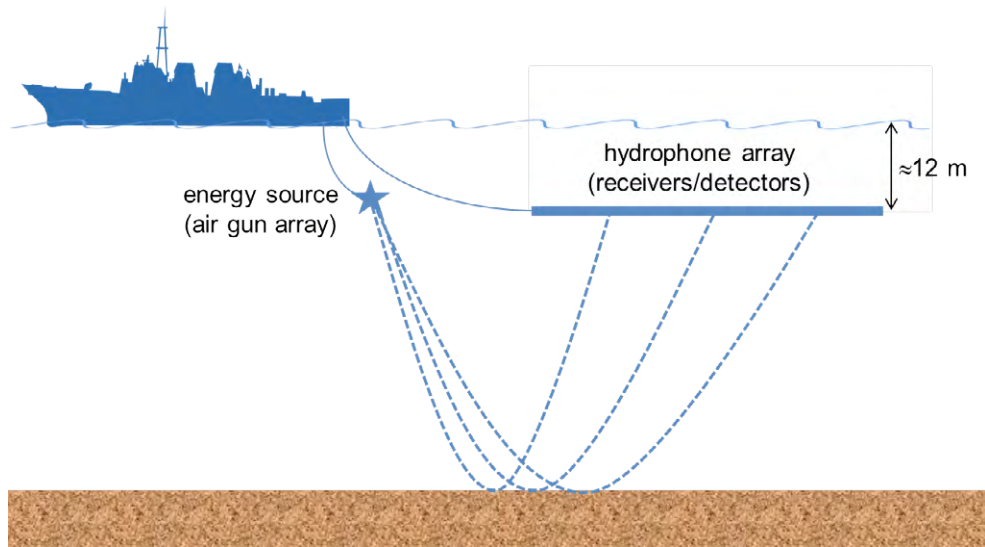

Figure 5-11. The use of sonar for the analysis of the ocean soil. During seismic surveys, high intensity, low frequency sounds are sent towards the earth's crust. They are reflected at different rates at certain geological boundaries. Analysis of the reflected sound informs the ship about the structure and composition of geological formations below the sea bed, as well as identify possible fossil fuel deposits.

Day one
and you're ready

Day one. It's the moment you've been waiting for. When you prove your worth, meet new challenges, and go looking for the next one. It's when your dreams take shape. And your expectations can be exceeded. From the day you join us, we're committed to helping you achieve your potential. So, whether your career lies in assurance, tax, transaction, advisory or core business services, shouldn't your day one be at Ernst & Young?

What's next for your future?
ey.com/careers

ERNST & YOUNG
Quality In Everything We Do

© 2010 EYGM Limited. All Rights Reserved.



Sonar is a technology that is applied during fishing as well – both to locate and assess the fish shoals for capture, as well as a deterrent for the natural predators on these shoals: marine mammals. Source levels for fish tracking range between 150 and 235 dB re 1 μ Pa at 1 m. The so-called acoustic harassment devices (AHDs) that are in use to warn marine mammals and deter them from approaching fish farm cages, produce high powered (190–205 dB) omni-directional sounds (10–25 kHz). These contraptions are sure to frighten away hungry seals or even induce pain to drive them away.

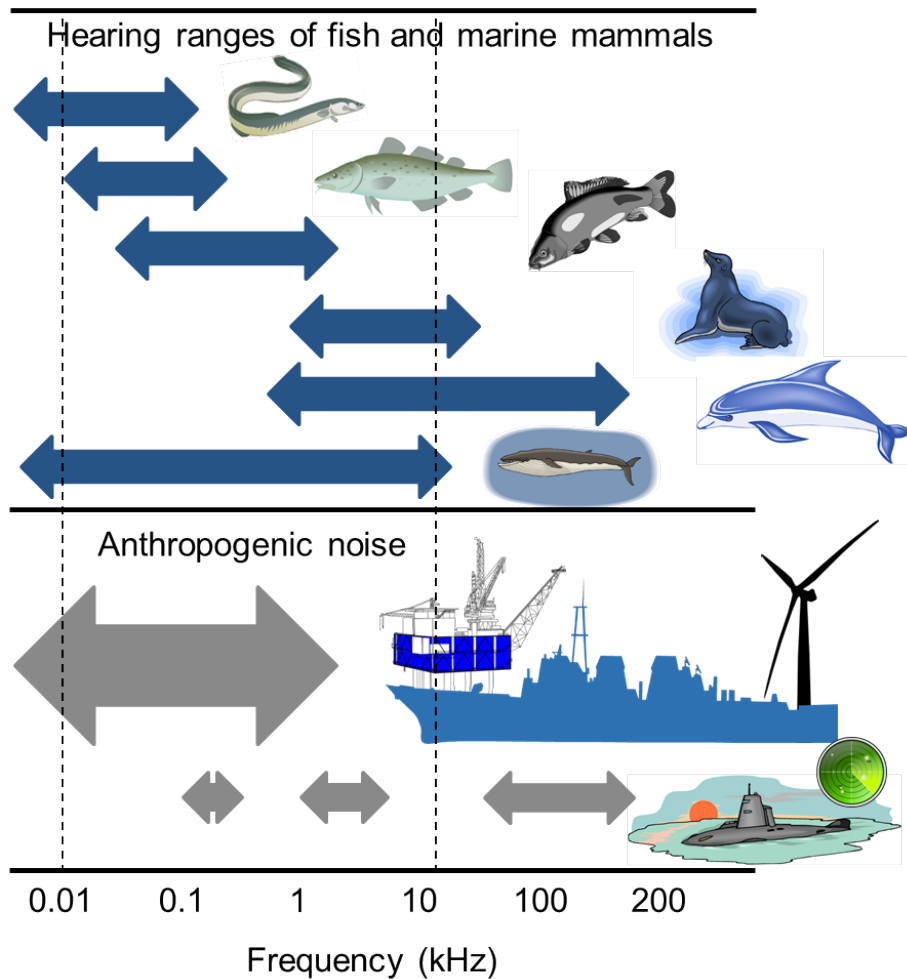

Figure 5-12. Overview of some important sources of sound in the marine world.

Nearly all commercial vessels as well as most of the smaller fishing boats (of which 17 million are owned in the USA alone!) are equipped with some kind of sonar. It is not too difficult to imagine what a bedlam this creates in the ears of the organisms in the oceans.

The marine world is also disturbed by regular explosions. Nuclear explosions (to test novel types of weaponry) used to contribute significantly (also because of the very intense sound waves that were generated). Nowadays, these tests happen only occasionally: underground tests in the United States continued until 1992, in the Soviet Union in 1990, the United Kingdom in 1991, and both China and France in 1996. By signing the Comprehensive Test Ban Treaty in 1996, all of these states have pledged to stop all nuclear testing.

Chemical explosions, however, are still widespread: for oceanic research (although there sonar has taken over), construction work (though in decline as well), and military testing (for example, of new military vessels. The SPL depends upon the charge weight w (in pounds):

$$\text{SPL dB re } 1 \mu\text{Pa at } 1 \text{ m} = 269 \text{ dB} + 7.35 \log_{10}(w)$$

Last but not least, there are a lot of industrial activities going on in the oceans nowadays. Companies drill for oil, construction platforms are being built, and in coastal regions windmill parks are being set up. In the vicinity of ports, rivers, estuaries and seas shipping lanes are being dredged. Dredging is said to deliver sounds with an average intensity of 160-180 dB re 1 μPa at 1 m (with peaks between 50 and 500 Hz). Drilling causes sounds of about 190 dB re 1 μPa at 1 m mainly between 10 Hz and 10 kHz. Other production activities (pumping, pipe laying, pile driving, cementing,...) generates levels of 135 dB re 1 μPa at 1 km (suggesting a level of 195 dB at 1 m).

5.2.3 Consequences for marine life

Whether noise pollution causes hearing losses as such in marine mammals, or whether hearing development has been affected in younger individuals, is still largely unclear. Some sources report actual lesions in the ears of sea mammals (see the documentary *The Death of the Oceans*, for example – <http://www.youtube.com/watch?v=ggxi0rsD5aU>, though these reports are still more or less fragmentary).

Nevertheless, even without causing actual physical damage, the noise clearly disrupts normal behaviour of sea mammals is disrupted on different levels by these outside sources. When the background noise becomes too loud, it drowns out those sounds that are relevant for the animals. This is known as masking. For example, icebreaker sounds mask the sounds that are important for beluga whales between 15 and 29 dB for up to around 40 km. The belugas respond by singing longer, louder and at a higher frequency. The same has been found for killer whales. On the other hand, sperm whales and pilot whales halt their singing. Humpback whales dive to deeper levels and remain there for longer periods. Belugas also leave the area and return only after a few days. Apart from these direct effects, there is a number of indirect consequences of exposure to higher levels of noise, probably due to an increased stress level: dolphins experience changes in heart rate and belugas have an increased level of stress hormones (adrenaline, dopamine). Admittedly, it is not yet possible to offer more than some fragmentary observations, but it is clear that noise pollution disturbs marine life at different levels. More observations are listed in Hildebrand (2005).

Cuvier’s beaked whales also seem to be frightened by sonar exposure, and marine biologists suspect they try to escape by stranding themselves. Three examples of this behaviour have been well documented. In May 1996, during a NATO military exercise using sonar in the Mediterranean Sea, eleven Cuvier’s beaked whales stranded on the coasts of Greece. In March 2002, fourteen Cuvier’s beaked whales, one spotted dolphin and two minke whales stranded themselves on the Bahamas – again, there were ships equipped with sonar in the neighbourhood. Six of the beaked whales and the spotted dolphin did not survive this. Closer examination showed unusually strong lesions in the ears. The most recent stranding dates from September 2002, when fourteen beaked whales threw themselves on the beaches of the Canary Islands, again, in the middle of a military training.

5.3 Hitching a ride: invasive species

As a last example of a new type of pollution, we present here the existence of invasive species. They can be seen as a form of biological pollution – species which invade and settle in territories that are not naturally theirs, and which disturb the ecological equilibriums in the new habitat. Nevertheless, they are important – consider this statement from the IMO from 2007 (cited in Minister of Public Works and Government Services Canada 2008):

In the past four years we have drilled

81,000 km

That’s more than **twice** around the world.

Who are we?
We are the world’s leading oilfield services company. Working globally—often in remote and challenging locations—we invent, design, engineer, manufacture, apply, and maintain technology to help customers find and produce oil and gas safely.

Who are we looking for?
We offer countless opportunities in the following domains:

- Engineering, Research, and Operations
- Geoscience and Petrotechnical
- Commercial and Business

If you are a self-motivated graduate looking for a dynamic career, apply to join our team.

What will you be?

Schlumberger

careers.slb.com

Click on the ad to read more

“Invasive marine species are one of the four greatest threats to the world’s oceans! Unlike other forms of marine pollution, such as oil spills, where ameliorative action can be taken and from which the environment will eventually recover, the impacts of invasive marine species are most often irreversible!”

5.3.1 A number of definitions

The first definition to discuss is that of the endemic species. Endemic species are uniquely associated with a particular place (an island, a habitat, a country, a lake, ...), and their appearance there is a consequence of the specific physical, climatic and biological characteristics of that place. A good example is the Orange-breasted Sunbird, *Anthobaphes violacea*, which is endemic to the fynbos (the natural shrub- and heathland vegetation of the Western Cape of South Africa), or the Galapagos iguana, of the same archipelago. The counterpart of endemic species is a cosmopolitan species – one that feels all over the world home. The rat is one such example. Then there are native species. Native species are, of course, at home in a particular region, but, in contrast to an endemic species, not strictly tied to a particular region. Native and endemic species are also species that live in their natural region, and are there due to natural causes and not by human intervention. It is possible that they arose elsewhere as a species, and that they have expanded naturally to new horizons.

In contrast, the concept of exotic species. Exotics are species that find themselves outside of their natural range, i.e. outside the area in which the species evolved or where the species has spread naturally (independently by man). Of course, species do not feel obliged to obey the borders that the human species has drawn, this can lead to absurd situations: so is the Monterey Cypress (*Cupressus macrocarpa*) considered to be an endangered endemic species in its original area in California, where the tree occurs only in two places. 80 km away, though, the same tree is considered to be an invasive species, which should be eliminated.... And where the wild hamster (*Cricetus cricetus*) is a sure sign of damage to agricultural crops in large areas of Europe (and one has to be rid of rich him), people in eastern Flanders, Belgium, try to protect the animal. The reason? The animal was settled there in recent years and starts to disappear. Or how biologists should never forget to think out of the box of their own natural habitat....

5.3.2 From exotic to invasive

For a species to be exotic or invasive, it needs some help from mankind. Throughout history, man has often moved organisms from continent to continent, knowingly and unknowingly. Prehistoric people introduced the Pacific rat (*Rattus exsulans*) in Polynesia. In the fourth century BCE, the Shu-Yuan Du trade route linked India with China. Along this route – according to ancient Chinese texts – the tamarind (*Tamarindus indica*) found its way into China. Often, settlers took species from their homeland, to act as livelihood in their new home. And some species from that new home turned out to be so useful that they were sent back to the motherland of the settlers.

Cattle, sheep, chickens, wheat, tomatoes, corn, potatoes, bees, fish, shellfish,... – they have all at least once crossed an ocean. 98% of the food currently grown in the U.S. comes from exotic plants and animals: soybeans, wheat, kiwi, sheep, cows,... And in their wake other species hitchhiked along: the medicinal St. John's Wort (*Hypericum perforatum*), or yarrow (*Achillea millefolia*). The Chinese crab *Eriocheir sinensis* species is thought to have been released deliberately into the San Francisco Bay, to harvest and eat the animal later.

Not every other exotic species will establish itself easily. Some species disappear again, because they can not survive in the new environment, because they can not cope with the competition in the new home, or because they fall prey to a native species for which the newcomer is nothing but a tasty snack. Organisms that can be expected to become strong invasive species are characterized by:

- rapid growth or reproduction (simply because an invasion is easier for organisms which produce more offspring);
- the ability to not only reproduce sexually, but asexually (by stolons, rhizomes,...), because this increases the ability to produce offspring;
- rapid spread (e.g. seeds) to occupy large areas without effort;
- tolerance to a wide range of conditions or life of different food sources (these species are generalists), as this increases the area where the organism can settle;
- usefulness to mankind, because he will protect such a species, rather than eradicate it.

Roughly 90% of the species that are transported unknowingly does not survive the transition to a new habitat. The remaining 10% is able to stay alive and happens to be seen now and then. They cause no harm whatsoever. 1% of the transported species, however, is able to establish a firm presence in its new home. These are called exotic species, or, with a more popular term, "hitch hikers". About 10% of these exotics even ends up threatening the normal ecological processes around them, chasing the local (endemic) organisms out of their habitat and niche, taking over the region, spreading new diseases, etc.... These species are called invasive. They are allegedly responsible for more than \$120 billion in annual losses in the US alone (Pimentel et al. 2005, Lovell et al. 2006).

5.3.3 Shipping and exotic species

As explained already in chapter 1, ships play an important role in the spread of exotic and invasive species (see Figure 5-13). Their ballast water contains a number of microscopic life forms, such as algae and larval forms of invertebrates, which will only be released days or weeks later, thousands of kilometres away from the region where the water (and the organisms) were taken up. Other organisms attach themselves to the ship hull in a process called biofouling, such as barnacles, bryozoans, molluscs, seaweed, hydroids, algae and bacteria (Williams et al. 1988, Reise et al. 1998, Bax et al. 2003, Drake et al. 2007, Molnar et al. 2008, Hulme et al. 2009).

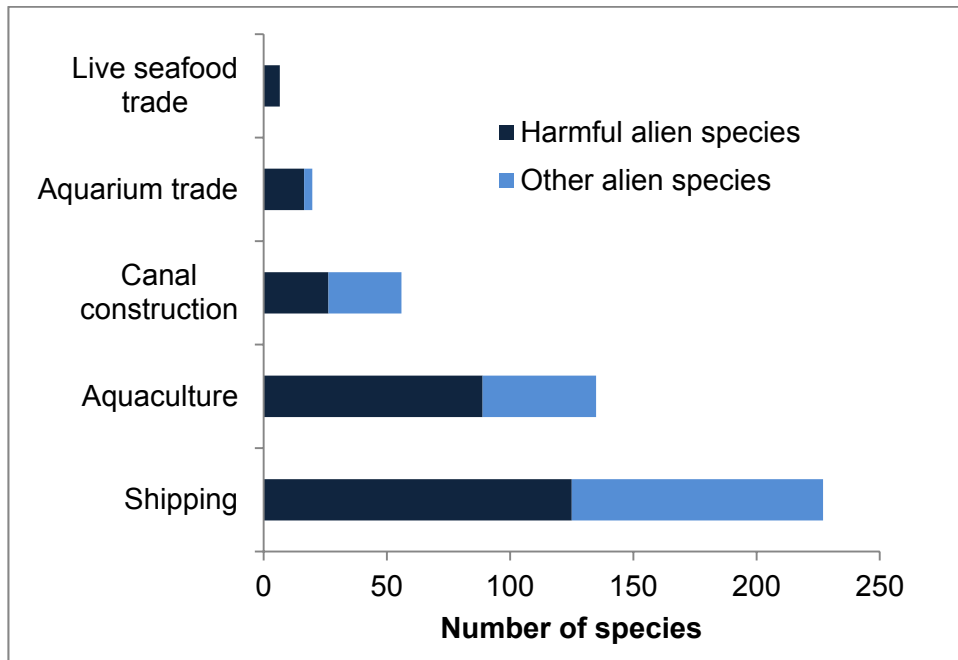



Figure 5-13. Number of marine exotic species introduced by the most common ways.
Source: Molnar et al. 2008



Hellmann's is one of Unilever's oldest brands having been popular for over 100 years. If you too share a passion for discovery and innovation we will give you the tools and opportunities to provide you with a challenging career. Are you a great scientist who would like to be at the forefront of scientific innovations and developments? Then you will enjoy a career within Unilever Research & Development. For challenging job opportunities, please visit www.unilever.com/rdjobs.

Could it be 
Unilever



Some examples of marine invaders comprise (see also Figure 5-14):

Rosy wolf snail (*Euglandina rosea*, a gastropod)

A species originating along the coast of Florida and Central America, but now found on the shores of the Pacific Islands.

From the beginning of the 1950s, the big African snail *Achatina fulica* was introduced in Tahiti as a food source – as always with the best intentions. However, *Achatina* soon became a threat to many local snail species (genus *Partula*). To counter this, the government decided in 1977 to introduce a second exotic snail: *Euglandina rosea*. *Achatina* population did decrease in number, but whether that was due to the arrival of *Euglandina*, has never been proven. It may just as well been caused by a disease that infected this African snail that decrease earlier. That local snail species benefited of the decline of *Achatina fulica* is certainly not true: instead of turning on this latter, as was intended, *Euglandina rosea* cheerfully preyed upon the local snail populations. A 2003 study (Coote and Loeve 2003) showed that there were no more *Partula* sp. individuals to be found anymore throughout French Polynesia, except for some zoos and breeding stations, acting as “wildlife reserves for snails” (Murray et al. 1988, Griffiths et al. 1993).



Figure 5-14. Several marine invasive species.

Top: *Achatina fulica* (Source: Thomas Brown, Wikimedia) – *Euglandina rosea* (Source: Tim Ross, Wikimedia);

Bottom: *Caulerpa taxifolia* (Source: NOAA) – *Mnemiopsis leidyi* (Source: Wikimedia) – *Dreissena polymorpha* (Source: USGS)

Amethyst gem clam (*Gemma gemma*, a bivalve mollusc)

A species originating along the coast of Labrador (Canada,) south along the western coast of the Atlantic, on both coasts of Florida, and along the coast of the Gulf of Mexico. Presently found on the Pacific coast of North America from the Puget Sound in Washington state to San Diego, California.

Gemma gemma had already introduced a century ago in the bays around California, though without significant effect, as the shell seems never to have had really negative effects on any native species. Until the middle of the 1990s, when the European green crab (*Carcinus maenas*) came from the twentieth century to come. This occurred only too happy too well that native shellfish, and it is *Gemma gemma* who has taken the vacant place.

Green Crab (*Carcinus maenas*)

Originally from European waters, this crab now inhabits the coasts of North America, southern South America, Australia, South Africa, and Japan. It is a voracious predator of many forms of shore life, including worms and molluscs. In some areas, the crab's appetite has affected the commercial shellfish industry.

Killer Algae (*Caulerpa taxifolia*)

Originally a native species of the Indian and Pacific Oceans, this tropical green seaweed has over time escaped public and private aquariums in California, Japan, Australia, and Monaco, and spread widely. For example, in the Mediterranean, it found a suitable habitat, at the expense of the native plants. In 2004, more than 131 km² was affected, along the coasts of six countries (Spain, France, Monaco, Italy, Croatia and Tunisia) (Thibaut and Meinesz 2004). As such, the alga drove out the habitat of many other marine organisms, causing a terrible loss in biodiversity. Researchers at the University of Nice have recently identified a tiny aquatic gastropod, *Elysia subornata*, which is a natural predator of *C. taxifolia*, and probably feeds exclusively on the alga (Thibaut et al, 2001).

Sea Walnut / North American Comb jelly (*Mnemiopsis leidyi*, a ctenophore)

Native to the east coast of North and South America, this jellyfish-like organism turned up in 1982 in the Black Sea, where it was probably transported to in a ballast tank. These organisms feed on the local zooplankton and thereby deprive the fish in commercial fisheries of their food. The organism has since also turned up in the Caspian, Mediterranean, Baltic, and North Seas (Shiganova 1998, Ivanov et al. 2000)

Zebra Mussel (*Dreissena polymorpha*, a bivalve mollusc)

This bivalve mollusc is native to the in fresh and brackish waters of the Caspian Sea, the lagoons of the Black Sea and their inflowing rivers.

The zebra mussel is a classic example of how a species were scattered by the international transport of goods and people by sea around the world. In the 18th and 19th centuries, it already spread through European canals, colonizing the Baltic Sea and many European river estuaries. In 1988, the species was found in the Great Lakes and in many rivers and lakes in eastern and central North America (Hebert et al. 1989, Strayer et al. 2004). Nevertheless, the zebra mussel is not in all respects a disaster. It is readily eaten by different species of waterfowl and contributes to a better water quality. On the other hand, the zebra mussel causes damage to ships, locks and cooling water systems, and displaces native species by devouring the available plankton and decreasing the food stocks, also for commercial fish (Hebert et al. 1991).

More examples can be found at

<http://www.issg.org/database/species/search.asp?st=100ss>.

5.4 Read more?

Bax, N., Williamson, A., Aguero, M., Gonzalez, E., & Geeves, W. (2003). Marine invasive alien species: a threat to global biodiversity. *Marine policy*, 27(4), 313–323.

Coote, T., & Loeve, E. (2003). From 61 species to five: endemic tree snails of the Society Islands fall prey to an ill-judged biological control programme. *Oryx*, 37(1), 91–96.



Discover the truth at www.deloitte.ca/careers

Deloitte.

© Deloitte & Touche LLP and affiliated entities.



Click on the ad to read more

Drake, L.A., Doblin, M.A., & Dobbs, F.C. (2007). Potential microbial bioinvasions via ships' ballast water, sediment, and biofilm. *Marine Pollution Bulletin*, 55(7), 333–341.

Gordon, J. and Moscrop, A. 1996. Underwater noise pollution and its significance for whales and dolphins. In *The Conservation of Whales and Dolphins* (ed. M.P. Simmonds and J.D. Hutchinson), 281–319. New York: Wiley and Sons.

Griffiths, O., Cook, A., & Wells, S.M. (1993). The diet of the introduced carnivorous snail *Euglandina rosea* in Mauritius and its implications for threatened island gastropod faunas. *Journal of Zoology*, 229(1), 79–89.

Groombridge B., Jenkins MD (2000) *Global biodiversity: Earth's living resources in the 21st century*. World Conservation Monitoring Centre, World Conservation Press, Cambridge.

Hebert, P.D., Muncaster, B.W., & Mackie, G.L. (1989). Ecological and genetic studies on *Dreissena polymorpha* (Pallas): a new mollusc in the Great Lakes. *Canadian Journal of Fisheries and Aquatic Sciences*, 46(9), 1587–1591.

Hebert, P.D., Wilson, C.C., Murdoch, M.H., & Lazar, R. (1991). Demography and ecological impacts of the invading mollusc *Dreissena polymorpha*. *Canadian Journal of Zoology*, 69(2), 405–409.

Hildebrand, J. (2005) Impacts of anthropogenic sound. In: *Marine mammal research – Conservation beyond crisis* (ed. Reynolds, J.E., III, Perrin, W.F., Reeves, R.R., Montgomery, S., Ragen T.J.), Johns Hopkins University Press, Baltimore, p. 100–123.

Hohn, D (2011) *MOBY-DUCK – The True Story of 28,800 Bath Toys Lost at Sea and of the Beachcombers, Oceanographers, Environmentalists, and Fools, Including the Author, Who Went in Search of Them*. Viking, 402 p. (ISBN 978-0670022199).

Hulme, P.E. (2009). Trade, transport and trouble: managing invasive species pathways in an era of globalization. *Journal of Applied Ecology*, 46(1), 10–18.

Ivanov, V.P., Kamakin, A.M., Ushivtzev, V.B., Shiganova, T., Zhukova, O., Aladin, N., Wilson S.I., Harbison GR, Dumont, H.J. (2000). Invasion of the Caspian Sea by the comb jellyfish *Mnemiopsis leidyi* (Ctenophora). *Biological Invasions*, 2(3), 255–258.

Lovell, S.J., Stone, S.F., & Fernandez, L. (2006). The economic impacts of aquatic invasive species: a review of the literature. *Agricultural and Resource Economics Review*, 35(1), 195.

Minister of Public Works and Government Services Canada (2008) March 2008 Status Report of the Commissioner of the Environment and Sustainable Development, Chapter 6: Control of Aquatic Invasive Species. Available at http://www.oag-bvg.gc.ca/internet/docs/aud_ch_cesd_200803_06_e.pdf.

Molnar, J.L., Gamboa, R.L., Revenga, C., & Spalding, M.D. (2008). Assessing the global threat of invasive species to marine biodiversity. *Frontiers in Ecology and the Environment*, 6(9), 485–492.

Murray, J., Murray, E., Johnson, M.S., & Clarke, B. (1988). The extinction of *Partula* on Moorea. *Pacific Science*, 42(3-4), 150–153.

Perry, C. 1998. A review of the impact of anthropogenic noise on cetaceans. Paper presented to the Scientific Committee at the 50th Meeting of the International Whaling Commission, 1998. SC/50/E9.

Reise, K., Gollasch, S., & Wolff, W.J. (1998). Introduced marine species of the North Sea coasts. *Helgoländer Meeresuntersuchungen*, 52(3–4), 219–234.

Shiganova, T.A. (1998). Invasion of the Black Sea by the ctenophore *Mnemiopsis leidyi* and recent changes in pelagic community structure. *Fisheries Oceanography*, 7(3-4), 305–310.

Simmonds M., Dolman, S., Weilgart, L. (2004) Oceans of noise. A WDCS Science report. WDCS, Chippenham, Wiltshire, UK, 169 p.

Strayer, D.L., Hattala, K. A., & Kahnle, A. W. (2004). Effects of an invasive bivalve (*Dreissena polymorpha*) on fish in the Hudson River estuary. *Canadian Journal of Fisheries and Aquatic Sciences*, 61(6), 924-941.

Thibaut, T., & Meinesz, A. (2004). *Caulerpa taxifolia*: 18 years of infestation in the Mediterranean Sea. *Aquatics Invasions in the Black, Caspian, and Mediterranean Seas*, 287–298.

Thibaut, T., Meinesz, A., Amade, P., Charrier, S., De Angelis, K., Ierardi, S., Mangialajo L, Melnick J., Vidal, V. (2001). *Elysia subornata* (Mollusca) a potential control agent of the alga *Caulerpa taxifolia* (Chlorophyta) in the Mediterranean Sea. *Journal of the Marine Biological Association of the United Kingdom*, 81(3), 497–504.

Williams, R.J., Griffiths, F.B., Van der Wal, E.J., & Kelly, J. (1988). Cargo vessel ballast water as a vector for the transport of non-indigenous marine species. *Estuarine, Coastal and Shelf Science*, 26(4), 409–420.

6 Policy and pollution

Eventually man [...] found his way back to the sea...
 And yet he has returned to his mother sea only on her own terms.
 He cannot control or change the ocean as, in his brief tenancy of earth,
 he has subdued and plundered the continents.

Rachel Carson, 1951, *The Sea around Us*

6.1 The How and Why of pollution: The Tragedy of the Commons

Why can't we take more care about our oceans? Why are we dumping our wastes in the seas without looking back? Why is there so much trash that ends up in the plastic soup of the garbage patches? Why are we catching every last fish in the oceans, leaving us, if the predictions are right, with not a single viable fish stock left by the latter half of the 21st century? Why is still only one per cent of the total ocean protected as a natural reserve? It's not as if we own them...or do we?

Grant Thornton—^{REALLY} a great place to work.

We're proud to have been recognized as one of Canada's Best Workplaces by the Great Place to Work Institute™ for the last four years. In 2011 Grant Thornton LLP was ranked as the fifth Best Workplace in Canada, for companies with more than 1,000 employees. We are also very proud to be recognized as one of Canada's top 25 Best Workplaces for Women and as one of Canada's Top Campus Employers.



Priyanka Sawant
Manager



Audit • Tax • Advisory
www.GrantThornton.ca/Careers



Grant Thornton
 An instinct for growth™

© Grant Thornton LLP. A Canadian Member of Grant Thornton International Ltd



One possible answer lies in what the ecologist Garrett Hardin called, back in 1968, the “Tragedy of the Commons”. A commons used to be a piece of land that belonged to the community. The land was available for every member of that community, and was meant to be used and managed together. Hence the problem. The land belonged to no one in particular, and it was therefore open for misuses. Because if every user starts to use a common resource like this piece of land as how it would be best for himself and his own interests, then the resource is quickly overused. To cite an example from 1833 – suppose you and your neighbours use the commons to feed your cows, and that there are just enough cows on the commons to provide for. If you decide to add one more cow to your herd, it will benefit you quite a lot (one extra cow to sell and to profit from). The cost will be a small extra burden for the community (all users of the commons). If every other farmer follows your example, soon the commons will be full of cows and devoid of grass. What once was a great common resource, is now plundered. Everyone loses.

On the other hand there are examples where a little action of everyone could solve a problem, but where many people are not eager to play their little part. Climate change is such an example. What we can do ourselves seems so insignificant on a world scale (and so substantial for our own life) that we fall into the trap of doing nothing. With tragic consequences in the long run. But that is another story. To cite the conservative philosopher Edmund Burke: “Nobody made a greater mistake than he who did nothing because he could do only a little.”

Our oceans are like those commons. Overused by everyone, and no one cares for the final price the earth will have to pay. And that is the Tragedy of the Commons all out.

If you want to know more about the concept of the commons, check out <http://www.iasc-commons.org>

6.2 The Oceans as Commons

Is this idea of the Commons purely an abstract idea, invented for the sake of a theoretical argument? Certainly not. Particularly in the maritime world, the concept of the Commons plays an important role in all kinds of international regulations and legislation, by clearly stating who owns (which parts of) the oceans: the 1982 United Nations Convention on the Law of the Sea (UNCLOS). UNCLOS came into force on November 16, 1994. It is probably the most important international treaty which provides a regulatory framework for the use of the world’s seas and oceans, in order to ensure that:

“the area of the seabed and ocean floor and the subsoil thereof, beyond the limits of national jurisdiction, as well as its resources, are the common heritage of mankind, the exploration and exploitation of which shall be carried out for the benefit of mankind as a whole” (Preamble of the UNCLOS Convention)

UNCLOS also deals with matters of sovereignty and rights of usage in maritime zones. As of 7 August 2013, 166 States had already ratified UNCLOS (Niger being the most recent one)¹¹. The USA has not ratified the Convention.

6.2.1 Mare Liberum

As such, the UNCLOS Convention is merely the modern expression of the legal expression of property rights over sea territory. Its first description dates back to the 17th century, to the publication of *Mare Liberum* by the Dutch jurist Hugo Grotius. He advocates that the use of the high sea for seafaring and trade is free for everyone:

“The air belongs to this class of things for two reasons. First, it is not susceptible of occupation; and second its common use is destined for all men. For the same reasons the sea is common to all, because it is so limitless that it cannot become a possession of any one, and because it is adapted for the use of all, whether we consider it from the point of view of navigation or of fisheries.”

Of course, this proposal paralleled the Dutch' effort to establish a powerful trade fleet for themselves. Competitor England opposed this idea with a number of publications of their own, for example in the legal document *An Abridgement of All Sea-Lawes* (1613) by the Scottish jurist William Welwood, or in the 1635 thesis *Mare Clausum* by John Selden. These works defended the position that certain bodies of water may be claimed as under the exclusive jurisdiction of a particular nation, in case, the British Empire. That they themselves thereby broke the Treaty of Tordesillas¹² between Portugal and Spain, was appropriately forgotten.

It was another Dutch jurist, Cornelius Bynkershoek, who found a suitable compromise in his essay “*De dominio maris*” (Dominion of the sea) in 1702. There, he argued that a coastal nation could claim dominion over so much of the sea as it could effectively control and protect (quite literally: as far as a cannon could protect it, hence the name of this compromise: the cannon-shot or three mile rule). This became universally accepted.



Figure 6-1. Three documents dealing with the ownership of the oceans.
 From left to right: the Treaty of Tordesillas – Mare Liberum – Mare Clausum.

6.2.2 UNCLOS

Appended by the three-mile rule, the *Mare liberum* principle remained the bedrock for all international trade at sea. Even in 1918, U.S. President Woodrow Wilson sought to reaffirm the absolute freedom of the seas outside territorial waters, after the First World War. However, the international community wanted to shift those existing borders. A first attempt in 1930 to find a compromise failed, leading to unilateral actions of several countries to expand their territorial waters. In 1967, only 25 countries still upheld the original three mile limit. Sixty-six countries had chosen for a twelve mile limit, and eight countries even defended a 200 mile border.

Under the influence of the United Nations, a new attempt was made to establish an international compromise: the **United Nations Convention on the Law of the Sea (UNCLOS)**. UNCLOS I (held between 1956 and 1958) indeed adopted four conventions, commonly known as the 1958 Geneva Conventions:

- The Convention on the Territorial Sea and Contiguous Zone;
- The Convention on the High Seas;
- The Convention on Fishing and Conservation of the Living Resources of the High Seas;
- The Convention on the Continental Shelf.

More details can be found at <http://untreaty.un.org/cod/avl/ha/gclos/gclos.html> and http://untreaty.un.org/ilc/texts/8_1.htm.

In spite of this huge step forward for the creation of an international frame for ownership of the oceans, the conventions ultimately failed to establish a maximum breadth of the territorial sea. UNCLOS II, held in 1960, did not succeed either.

A third attempt was finally successful. UNCLOS III, an effort which ran from 1973 to 1982, led to an internationally accepted text, which was subsequently ratified. It entered into force one year after the sixtieth country had ratified it – on 16 November 1994. These first sixty ratifications were almost all developing states.

A major breakthrough in the UNCLOS convention included the definition of maritime zones (Figure 6-2 and Table 6-1): the territorial sea, the contiguous zone, the exclusive economic zone, the high sea, and archipelagic waters. The convention also made provision for the passage of ships, protection of the marine environment, freedom of scientific research, and exploitation of resources.

The limit of the territorial waters is now, due to UNCLOS, set at 12 miles (approximately 22 kilometers) from the coast. Within this territory, the coastal state is free to set laws, regulate use, and use any resource. Other vessels are allowed the right of innocent passage: defined by the convention as passing through waters in an expeditious and continuous manner, which is not “prejudicial to the peace, good order or the security” of the coastal state. Fishing, polluting, weapons practice, and spying are not “innocent”, and submarines and other underwater vehicles are required to navigate on the surface and to show their flag.

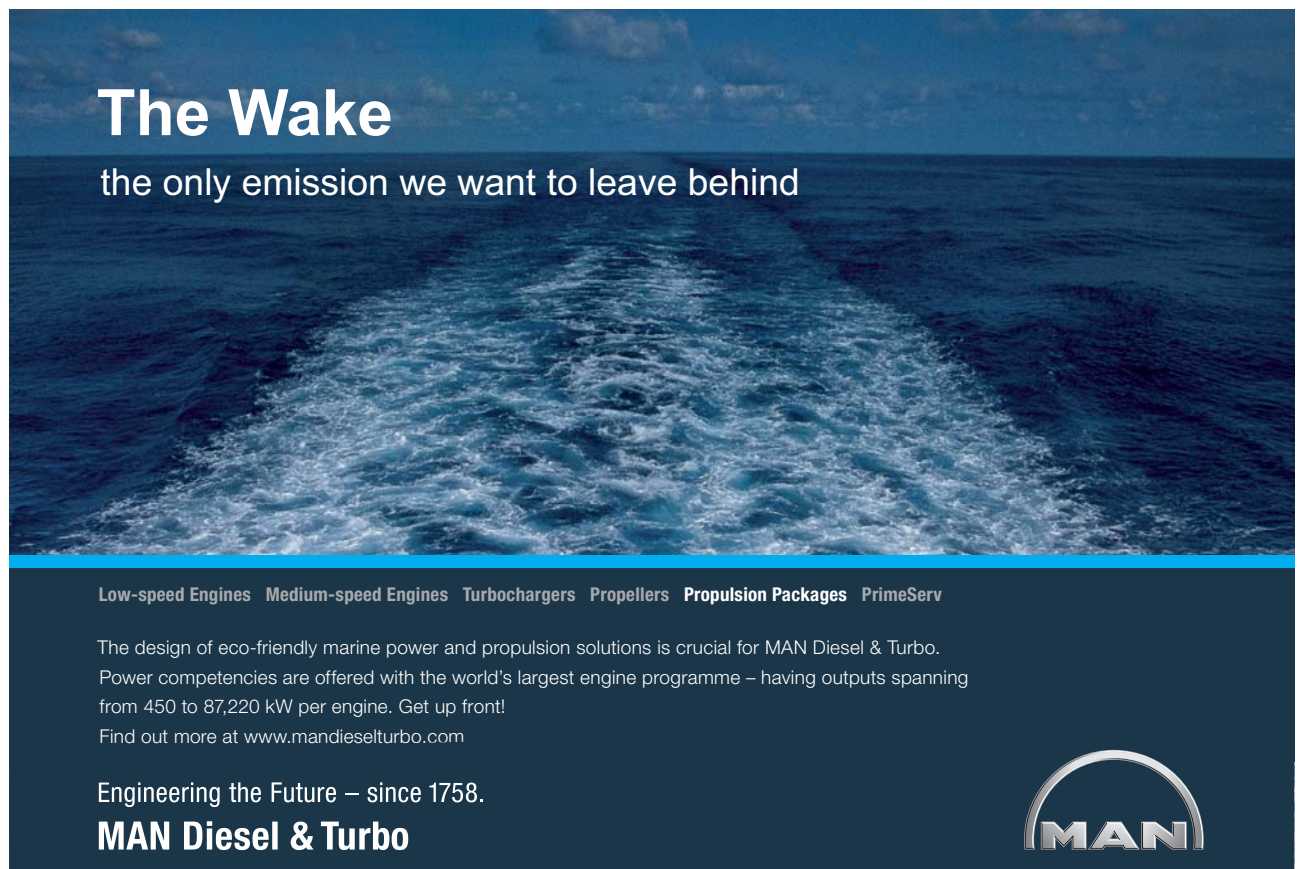

The Wake
the only emission we want to leave behind

Low-speed Engines Medium-speed Engines Turbochargers Propellers Propulsion Packages PrimeServ

The design of eco-friendly marine power and propulsion solutions is crucial for MAN Diesel & Turbo. Power competencies are offered with the world's largest engine programme – having outputs spanning from 450 to 87,220 kW per engine. Get up front! Find out more at www.mandieselturbo.com

Engineering the Future – since 1758.
MAN Diesel & Turbo



Click on the ad to read more

Moreover, UNCLOS defines a number of freedoms for everyone outside of these territorial waters (Art 87). These high seas are open to all states, whether coastal or land-locked. More in detail, the freedom of the high seas comprises:

- Freedom of navigation
- Freedom of overflight
- Freedom to lay submarine cables and pipelines
- Freedom to construct artificial islands and other installations
- Freedom of fishing
- Freedom of scientific research

The full text of the Convention can be found at:
http://www.un.org/depts/los/convention_agreements/texts/unclos/unclos_e.pdf

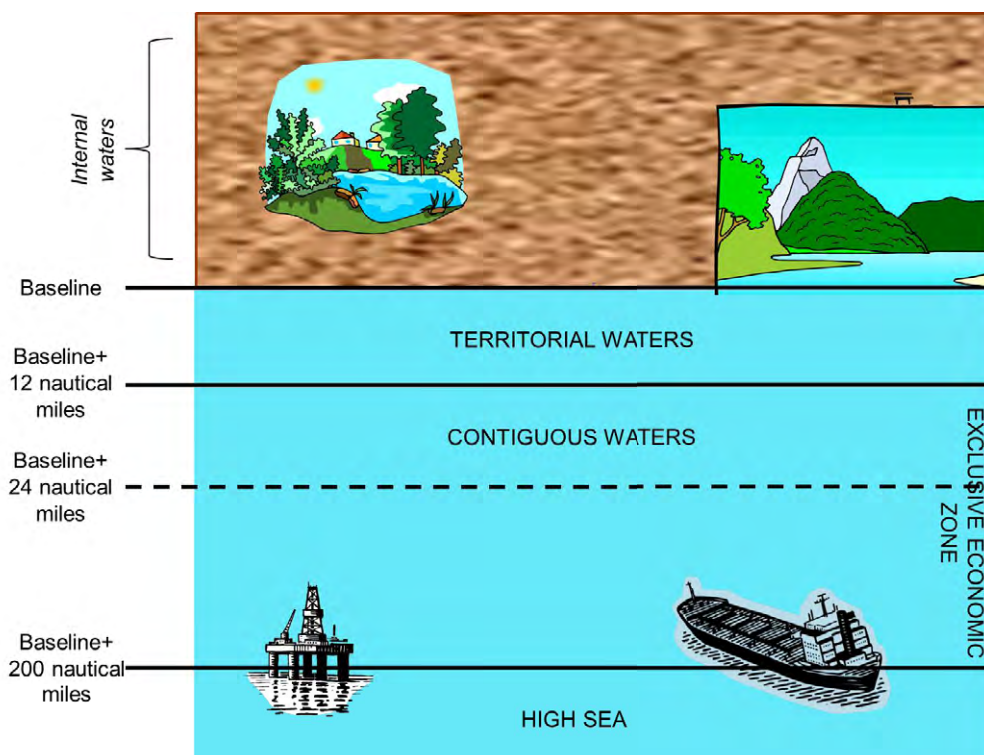

Figure 6-2. Borders and zones at sea according to UNCLOS.

Zone	Definition	Rights of Coastal State ^b	Rights of foreign vessel
Internal waters	all water and waterways on the landside of the baseline ^a	All rights awarded: to set laws, to regulate use, and to use all resources	
Territorial waters	12 nautical miles (22 km) from the baseline ^a	All rights awarded: to set laws, to regulate use, and to use all resources	Innocent passage
Archipelagic waters	12 nautical miles (22 km) from the outermost points of the outer islands	All rights awarded: to set laws, to regulate use, and to use all resources	Innocent passage
Contiguous zone	12 nautical miles (22 km) beyond the territorial waters	to set laws on customs, taxation, immigration and pollution	
Exclusive economic zones (EEZs)	200 nautical miles (370 km) beyond the baseline (188 nautical miles from territorial waters)	sole exploitation rights over all natural resources	Freedom of navigation and overflight. Foreign states may also lay submarine pipes and cables
High seas	Beyond the EEZs	Open to all states	

Table 6-1. Borders at sea

^aThis baseline is normally the low-water line, unless the coastline is deeply indented, has fringing islands or is highly unstable.

^bLandlocked states are given a right of access to and from the sea, without taxation of traffic through transit states.

6.3 International Convention for the Prevention of Pollution from Ships (MARPOL)

6.3.1 Before MARPOL

When a resource belongs to a community instead of a person, a good set of rules and agreements is needed to manage this resource. When it comes to the oceans, this task falls under the authority of the UN and its maritime wing, the International Maritime Organisation (IMO), which has come into existence in 1948 in Geneva with the IMO Convention and which finally established its physical presence in 1959, under the motto “Safe, Secure and Efficient Shipping on Clean Oceans”. The IMO deals firstly with aspects of safety at sea (through the ongoing work on the *Safety of Life at Sea Convention* (SOLAS)) and secondly with requirements on training for seafarers (through the *International Convention on Standards of Training, Certification and Watchkeeping for Seafarers* (STCW)). Besides this, the organisation provides regulations on how the international community should deal with the marine environment are brought together in the *International Convention for the Prevention of Pollution from Ships* (MARPOL). It is the main international convention dealing with prevention of pollution of the marine environment by ships from operational or accidental causes.

The first international treaty that tried to find a world consensus on an environmental maritime issue was the Oil Pollution Convention (OILPOL) of 1954. Its aim was to diminish marine pollution by oil tankers by prohibiting tankers to discharge oil, or any oil-containing mixture (containing more than 100 ppm of oil), closer than 50 miles from the nearest land. The choice for oil was only natural: as the demand for oil skyrocketed after the Second World War, so did the visibility of the accidents with oil tankers, as well as the quantities of oil that were spilt during normal tanker operations. The Convention entered into force on 26 July 1958 (Roman 2008).

Upon the founding of the IMO, the OILPOL convention was taken up into this organisation, and amended further in 1962, 1969 and 1971. In 1971, for instance, the Convention was amended to impose new standards on the construction of oil tankers. Later, the 1973/78 MARPOL Convention subsumed the 1954 Convention (as Annex I) and rendered the original obsolete.

The RBS Group logo, featuring a stylized sunburst icon to the left of the text "RBS Group".

CAREER KICKSTART

An app to keep you in the know

Whether you're a graduate, school leaver or student, it's a difficult time to start your career. So here at RBS, we're providing a helping hand with our new Facebook app. Bringing together the most relevant and useful careers information, we've created a one-stop shop designed to help you get on the career ladder – whatever your level of education, degree subject or work experience.

And it's not just finance-focused either. That's because it's not about us. It's about you. So download the app and you'll get everything you need to know to kickstart your career.

So what are you waiting for?

Click [here](#) to get started.



6.3 MARPOL 73/78: it all started with oil pollution measures...

The incident that was directly responsible for spawning new talks for an improved convention was the accident of the tanker *Torrey Canyon* in 1967. The ship spilled its entire cargo (120 000 tons of crude oil) in the English Channel, causing the biggest oil pollution incident ever recorded up to then. Evidently, a number of questions were asked as to the efficacy of the regulations that were operational at that time. It was decided to organise a new international conference in 1973 to present suitable answers to these questions, to renew the international agreements and to improve the restraints on merchant ships. In the meanwhile, the OILPOL Convention was amended further to deal with a number of direct consequences: the Great Barrier Reef of Australia was allowed extra protection, and the size of the tanks on oil tankers was limited, which minimised the amount of oil which could escape in the case of an accident.

The MARPOL Convention was adopted on 2 November 1973 at IMO. Its main objective is the global prevention of pollution of the marine environment, by severely diminishing the operational discharge of many kinds of pollutants, and by minimising the chance of an accidental discharge of such substances. Even more so, the Conference concluded that the former was a much bigger problem than the latter. Hence, a first set of rules, focused on oil discharges, was bundled in Annex I. Other Annexes, dealing with harmful substances, sewage and garbage, were also already envisioned by the Conference, and the 1973 Convention already presented two separate Protocols on *Reports on Incidents involving Harmful Substances* and *Arbitration*.

Nevertheless, the outcome was simply disappointing. While the 1973 Convention required a ratification by 15 states, representing at least 50% of the world merchant fleet (expressed in gross tonnage), only three countries (for less than one per cent of the fleet) actually ratified the document. It seemed like another lost effort.

In 1978, however, the IMO held another conference, in response to a series of tanker accidents: the *Argo Merchant* in 1976, the *Ekofisk* in 1977 and the *Amoco Cadiz* in 1978. The *Amoco Cadiz* accident produced the largest oil spill ever.

Several technical measures were taken in order to avoid similar catastrophes in the future. Firstly, there was the obligation to provide *completely segregated ballast tanks* on board of tankers larger than 20 000 DWT¹³. This avoids any mix between crude oil (from the cargo) and ballast water, which can therefore be discharged again without taking along some of the oil. Moreover, these ballast tanks had to be located protectively: in such a way that these (water) tanks would help to protect the cargo tanks in case the ship suffered a collision or ran aground. Furthermore, measures were taken to ensure a stricter enforcement of the regulations for survey and certification of the ships.

Also, novel regulations were put into place to ensure a more ecological way of cleaning the cargo tanks. This used to be done with *seawater jets* – water that was afterwards pumped overboard again leading to a significant quantity of oil to be discharged with the cleaning water. Therefore, during the 1960s, ships started to use a slop tank: a separate tank in which the heavier water and the lighter crude oil could unmix and the water could then be discharged with lower amounts of oil.

These discharges from seawater washing were still considered a problem and during the 1960s the so-called load on top approach was adopted. The mixture of cleaning water and residue was pumped into a *cargo tank* and allowed to separate into oil and water during the journey. The water portion was then discharged, leaving the crude oil in the cargo tank. The new cargo was then loaded on top of it, recovering as much as 800 tons of oil which was formerly discarded. Finally, during the 1970s, the water was replaced by crude oil itself, in an innovative step called *crude oil washing*.

The measures that were taken in the wake of these events, were incorporated in a revised version of the 1973 MARPOL text. The combined text – the **International Convention for the Prevention of Marine Pollution from Ships, 1973 as modified by the Protocol of 1978 relating thereto (MARPOL 73/78)** – finally entered into force on 2 October 1983 and on 6 April 1987 (respectively for Annexes I and II). Further updates and expansion of the original MARPOL Convention has been done through a series of six Annexes¹⁴ and a series of amendments over the years.

For example, all the measures and regulations regarding oil pollution are listed in Annex I, covering all forms of pollution by oil from operational measures as well as from accidental discharges. The most important amendment to this Annex probably came about in 1992, when it became mandatory for new oil tankers to have double hulls, and for existing tankers to follow a schedule to be phased out in favour of new models equipped with double hulls.



Figure 6-3. The Exxon Valdez.
Source: NOAA.

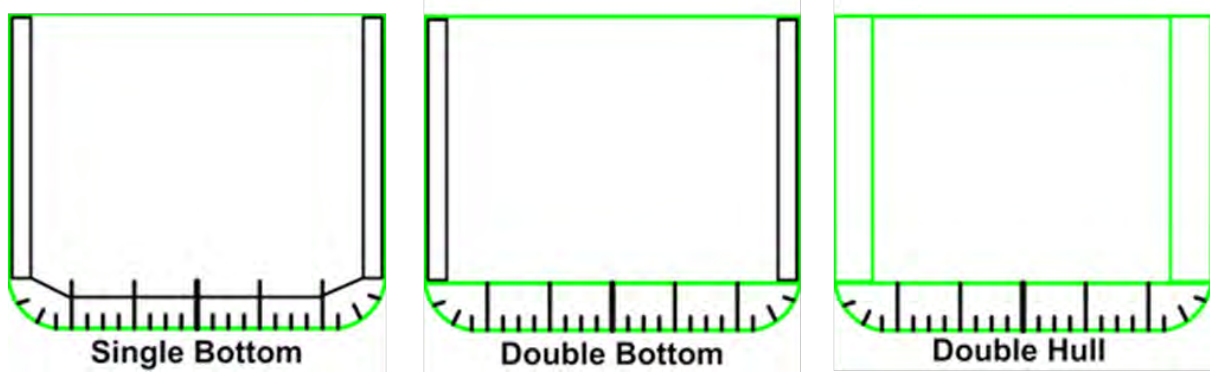

Figure 6-4. The double hull configuration.

The double hull is a ship hull design where the bottom and sides of the ship consist of two complete layers of watertight surface (in green): one outer layer forming the normal hull of the ship, and a second inner hull, in contact with the cargo holds and tanks. This inner layer forms a redundant barrier to seawater in case the outer hull is damaged and leaks. Black lines indicate surfaces which are not watertight and contain, e.g. manholes. The space between the two hulls usually serves as ballast tank (though not necessarily so).

Source: Georgewilliamherbert , Wikipedia.

ORACLE®

Be BRAVE

enough to reach for the sky

Oracle's business is information - how to manage it, use it, share it, protect it. Oracle is the name behind most of today's most innovative and successful organisations.

Oracle continuously offers international opportunities to top-level graduates, mainly in our Sales, Consulting and Support teams.

If you want to join a company that will invest in your future, Oracle is the company for you to drive your career!

<https://campus.oracle.com>



ORACLE®

ORACLE IS THE INFORMATION COMPANY



Click on the ad to read more

Again, it took a disaster before these steps were taken. On 24 March 1989, shortly after midnight, the oil tanker *Exxon Valdez* (Figure 6-3) struck Bligh Reef in Prince William Sound, Alaska, spilling 37 000 tonnes of crude oil. The spill was the largest in U.S. history (though only the 35th worldwide, see Table 4-4), but the vulnerability¹⁵ of the surrounding region ensured a quick and decisive response from the US government: they formulated the Oil Pollution Act (1990), which imposed a new ship design for all tankers carrying oil in US territorial waters, called the double hull (Figure 6-4). IMO followed a few years later and the double hull design became obligatory by the MARPOL convention in 1993 for newly built ships. In contrast with the USA legislation, MARPOL provided the possibility to introduce alternative designs if an equivalent protection was guaranteed by these designs.

Hydrocarbons originating from the engines could only be discharged at concentrations lower than 15 ppm (meaning, as soon as the oil is visible at the surface of the water, the concentration was too high!). In addition, for hydrocarbons originating from cargo (aboard oil tankers), the Annex gave birth to the concept of special areas (listed in Table 6-5). In specifically designated zones of the oceans, hydrocarbons originating from the cargo could no longer be discharged.

6.4 The MARPOL Annexes: beyond oil pollution

A thorough description of the detailed measures that each Annex provides in order to enhance the ecologically responsible character of shipping as a major transport mode, would lead us too far and would become too technical. This would better be treated in a volume on green shipping technology.

The first non-oil related was Annex II which details all measures which control the pollution by noxious liquid substances transported in bulk (see for a related list the GESAMP regulations listed in Table 2-3).

6.4.1 Annex III: Prevention of Pollution by Harmful Substances in Packaged Form

Annex III (which entered into force 1 July 1992) deals with packaged pollutants. These are chemicals with a high potential to bioaccumulate in seafood or with a high toxicity to aquatic life. They are usually identified as marine pollutants in the International Maritime Dangerous Goods Code (IMDG Code) or otherwise meet the criteria in the Appendix of Annex III. Mixtures and solutions of 10% (1% for severe marine pollutants) also fall under the regulations of Annex III (Table 6-2).

The Annex furthermore lists the general requirements for the issuing of detailed standards on packing, marking, labelling (Figure 6-5), documentation, stowage, quantity limitations, exceptions and notifications.

Category: Acute 1		
96 h LC ₅₀ (for fish)		≤ 1 mg L ⁻¹ and/or
48 h EC ₅₀ (for crustacea)		≤ 1 mg L ⁻¹ and/or
72 or 96 h EC ₅₀ (for algae or other aquatic plants)		≤ 1 mg L ⁻¹
Category: Chronic 1		
96 h LC ₅₀ (for fish)		≤ 1 mg L ⁻¹ and/or
48 h EC ₅₀ (for crustacea)		≤ 1 mg L ⁻¹ and/or
72 or 96 h EC ₅₀ (for algae or other aquatic plants)		≤ 1 mg L ⁻¹
<i>and the substance is not rapidly degradable and/or the log Kow ≥ 4 (unless the experimentally determine BCF < 500)</i>		
Category: Chronic 1		
96 h LC ₅₀ (for fish)		>1 to ≤ 10 mg L ⁻¹ and/or
48 h EC ₅₀ (for crustacea)		>1 to ≤ 10 mg L ⁻¹ and/or
72 or 96 h EC ₅₀ (for algae or other aquatic plants)		>1 to ≤ 10 mg L ⁻¹
<i>and the substance is not rapidly degradable and/or the log Kow ≥ 4 (unless the experimentally determine BCF < 500), unless the chronic toxicity NOECs are > 1 mg L⁻¹</i>		

Table 6 -2. Appendix to Annex III

Criteria for the identification of harmful substances in packaged form.

**Figure 6-5.** Labels to identify marine pollutants.

6.4.2 Annex IV: Prevention of Pollution by Sewage from Ships

As discussed in 3.1, organic nutrients are the main cause of eutrophication of lakes, seas and oceans. The main sources of human-produced sewage are land-based – such as municipal sewers or treatment plants. Nevertheless, ships do produce significant volumes of sewage water as well: for example, a cruise ship with 3,000 passengers and crew can produce nearly 1 million L of wastewater and around 120 000 L of sewage per day. For a good understanding – MARPOL Annex IV only deals with sewage of black water: wastewater containing fecal matter and urine, originating from, toilets, urinals and WC scuppers, medical premises, spaces with living animals or water that is mixed with one of these sources. For the time being, there is no IMO regulations dealing with grey water (coming from the galley, showers, washing machines,...)

Since 27 September 2003, Annex IV regulates the pollution of the sea by sewage, for ships larger than 400 gross tonnage or with more than 15 persons on board. These ships are allowed to discharge their sewage water only outside the territorial waters (more than 12 nautical miles from the nearest land). When the ship uses a comminuting and disinfecting system it is allowed to discharge its wastewater more than three nautical miles from the nearest land. When the ship operates an approved sewage treatment plant, there are no such limits. Nevertheless, there should be no production of visible solids in, or discoloration of the surrounding water. In all other cases, the wastewater has to be collected and transferred to a specific reception facility on land.

Amendments introduced in July 2011 (and in force since 1 January 2013) designate the Baltic Sea as a special area¹⁶ (see Table 6-5) and add new discharge requirements for passenger ships while in such an area.

6.4.3 Annex V Prevention of Pollution by Garbage from Ships

For the MARPOL Convention, garbage consists of domestic garbage, food waste, waste linked to ship operations, plastic, cargo residues, cooking oil, fishing gear, animal carcasses and so on. The measures in Annex V determine how this garbage should be disposed of.

The original Annex entered into force 31 December 1988; in July 2011, extensive amendments were introduced, which have since then entered into force (on 1 January 2013). The revised Annex V prohibits the discharge of all garbage into the sea, except as provided otherwise, under specific circumstances (Table 6-3).

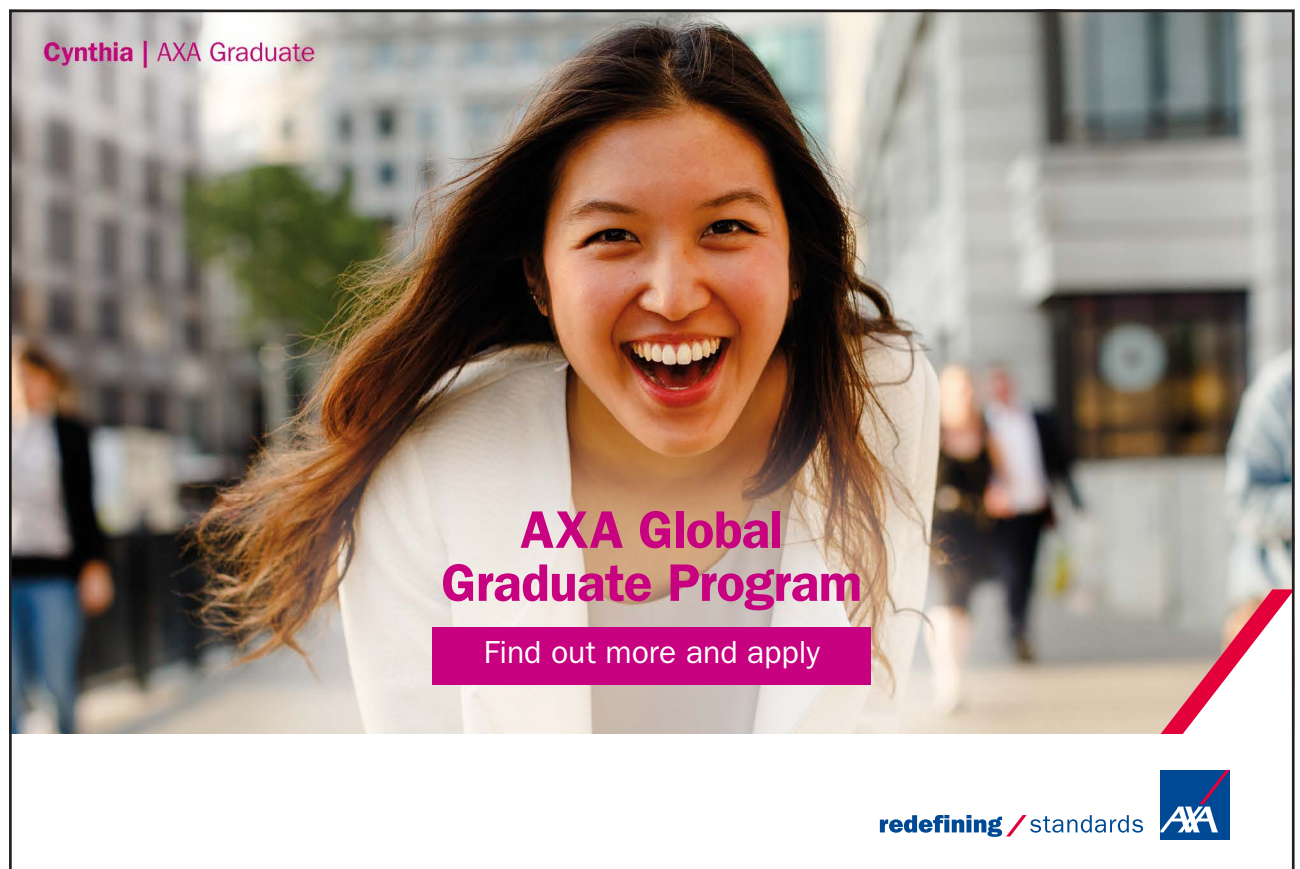

Cynthia | AXA Graduate

AXA Global Graduate Program

Find out more and apply

redefining / standards AXA

Type of garbage	Ships outside special areas	Ships within special areas	Offshore platforms (more than 12 nautical miles from land) and all ships within 500 m of such platforms
Food waste, comminuted or ground	Discharge permitted (more than 3 miles from the nearest land, en route and as far as practicable)	Discharge permitted (more than 12 miles from the nearest land, en route and as far as practicable)	Discharge permitted
Food waste, not comminuted or ground	Discharge permitted (more than 12 miles from the nearest land, en route and as far as practicable)	Discharge prohibited	Discharge prohibited
Cargo residues ¹ not contained in wash water	Discharge permitted (more than 12 miles from the nearest land, en route and as far as practicable)	Discharge prohibited	Discharge prohibited
Cargo residues ¹ contained in wash water		Discharge permitted (more than 12 miles from the nearest land, en route, as far as practicable, and subject to additional conditions ²)	Discharge prohibited
Cleaning agents and additives ¹ contained in cargo hold wash water	Discharge permitted	Discharge permitted (more than 12 miles from the nearest land, en route, as far as practicable, and subject to additional conditions ²)	Discharge prohibited
Cleaning agents and additives ¹ in deck and external surfaces			Discharge permitted
Carcasses of animals carried on board as cargo, which died during the voyage	Discharge permitted (as far from the nearest land as possible and en route)	Discharge prohibited	Discharge prohibited
All other garbage (incl. plastics, synthetic ropes, fishing gear, plastic garbage bags, incinerator ashes, clinkers, cooking oil, floating dunnage, lining and packing materials, paper, rags, glass, metal, bottles, crockery, and similar refuse)	Discharge prohibited	Discharge prohibited	Discharge prohibited
Mixed garbage	When garbage is mixed with or contaminated by other substances prohibd from discharge or having different discharge requirements, the more stringent requirements shall apply		

Table 6-3. MARPOL garbage disposal criteria (from 2013 onwards).

1. Substances not harmful to the environment, ex from bulk carriers, not other annex
2. Only when loading, discharging port and complete transit passage in special area

6.4.4 Annex VI: Prevention of Air Pollution from Ships

MARPOL Annex VI deals with gaseous emissions of ship engines and installations: the Convention regulates sulfur oxide, nitrogen oxide and particulate matter emissions from ship exhausts and prohibits deliberate emissions of ozone depleting substances. It also contains provisions allowing for the creation of special Emission Control Areas (ECAs) with even more stringent controls on air pollutant emissions. The original version entered into force 19 May 2005; in 2008 however, some fundamentally new measures were introduced meant to reduce the amount of greenhouse gas emissions from ships. The world adopted the revised MARPOL Annex VI and the associated NO_x Technical Code 2008, which entered into force on 1 July 2010.

Sulfur in the ship's fuel will have to be diminished as follow:

- since 1 January 2012, fuels with more than 3.5% of S are not allowed anymore;
- from 1 January 2020, the upper limit will be 0.50%;
- in SECAS, S content cannot be higher than 1.00% (since 1 July 2010) and this limit will be reduced to 0.10%, from 1 January 2015 onwards.

which will evidently also lower general SO_x emissions by the maritime sector.

NO_x emission limits depend upon maximum performance (expressed in crankshaft revolutions per minute, n) of a ship's engine, as shown in Table 6-4. Several levels exist in this case, the so-called Tiers. Tier I and Tier II are global limits, while the Tier III standards will apply only in NO_x ECAs. Tier I gives the maximal emission level for ships constructed before 1/1/2011; Tier II gives the maximal emission level for ships constructed from 1/1/2011 onwards. Tier III levels are imposed on ships that will be constructed from 1/1/2016 onwards, for ships that are meant to sail in ECAs.

Tier	Date	NO _x Limit (g/kWh)		
		n < 130	130 ≤ n < 2000	n ≥ 2000
I	2000	17.0	45·n ^{-0.2}	9.8
II	2011	14.4	44·n ^{-0.23}	7.7
III	2016	3.4	9·n ^{-0.2}	1.96

Table 6-4. NO_x limits in function of engine performance

Annex VI also forbids any (deliberate) emission of an ozone depleting substance, such as halons and chlorofluorocarbons (CFCs), as well as any new installation of equipment using these gases.

Lastly, there are also the greenhouse gases (and then especially CO₂). To come to an efficient use of energy (and therefore, fossil fuels) and to limit CO₂ emissions, two instruments were created. Firstly there is the Energy Efficiency Design Index (EEDI), for new ships. This (complex!) parameter is a measure for the CO₂ efficiency of a vessel at a certain DWT and speed, and is obligatory for all new ships. A variant, the Energy Efficiency Operational Index (EEOI), is facultative, for existing ships. Secondly, all ships need to have a Ship Energy Efficiency Management Plan (SEEMP), to guide them to improve their overall energy efficiency in a cost-effective manner.

Adoption, entry into force & date of taking effect of Special Areas	
Special Areas	Adopted
Annex I: Oil	
Mediterranean Sea	2 Nov 1973
Baltic Sea	2 Nov 1973
Black Sea	2 Nov 1973
Red Sea	2 Nov 1973
“Gulfs” area	2 Nov 1973
Gulf of Aden	1 Dec 1987
Antarctic area	16 Nov 1990
North West European Waters	25 Sept 1997
Oman area of the Arabian Sea	15 Oct 2004
Southern South African waters	13 Oct 2006
Annex II: Noxious Liquid Substances	
Antarctic area	30 Oct 1992
Annex IV: Sewage	
Baltic Sea	15 Jul 2011
Annex V: Garbage	
Mediterranean Sea	2 Nov 1973
Baltic Sea	2 Nov 1973
Black Sea	2 Nov 1973
Red Sea	2 Nov 1973
“Gulfs” area	2 Nov 1973
North Sea	17 Oct 1989
Antarctic area (south of latitude 60 degrees south)	16 Nov 1990
Wider Caribbean region including the Gulf of Mexico and the Caribbean Sea	4 Jul 1991
Annex VI: Prevention of air pollution by ships (Emission Control Areas)	
Baltic Sea (SOx)	26 Sept 1997
North Sea (SOx)	22 Jul 2005
North American (SOx, and NOx and PM)	26 Mar 2010
United States Caribbean Sea ECA (SOx, NOx and PM)	26 Jul 2011

Table 6-5. Special areas according to the different MARPOL Annexes.

Source: <http://www.imo.org/OurWork/Environment/PollutionPrevention/SpecialAreasUnderMARPOL/Pages/Default.aspx>

6.5 Read more?

Roman, A. (2008). Oil Pollution (OILPOL) Convention of 1954, United States. Retrieved from <http://www.eoearth.org/view/article/155005>

For those who want to explore the maritime world further:
(all links checked in August 2013)

<http://www.imo.org>

<http://www.imo.org/KnowledgeCentre/Pages/Default.aspx>

<http://www.prosea.info>

<http://www.intertanko.com>

<http://www.intertanko.com/Topics/Environment/>

<http://www.uscg.org>

<http://www.ics-shipping.org/>

<http://globallast.imo.org>

<http://www.imarest.org>

<http://www.un.org/depts/los/index.htm>

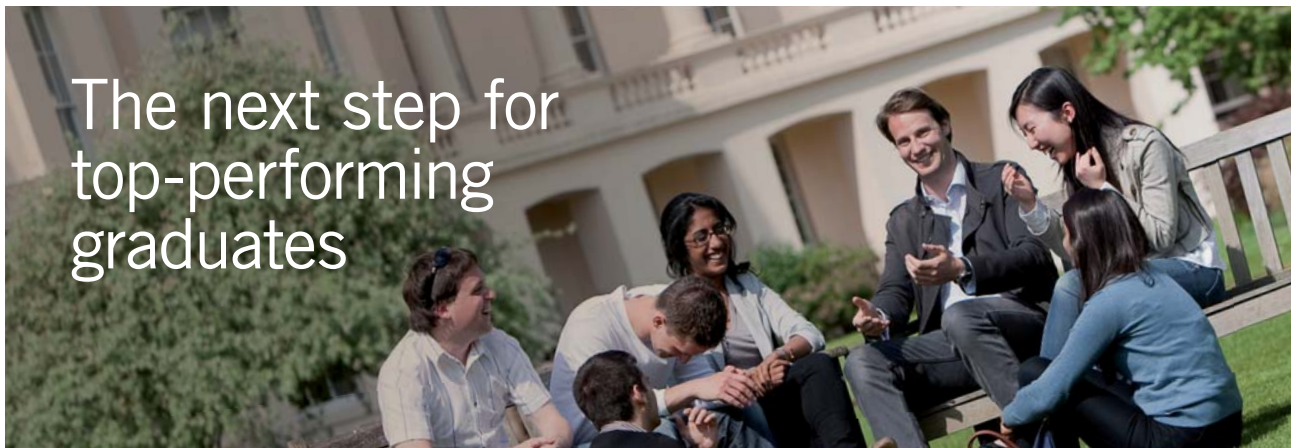

Masters in Management



Designed for high-achieving graduates across all disciplines, London Business School's Masters in Management provides specific and tangible foundations for a successful career in business.

This 12-month, full-time programme is a business qualification with impact. In 2010, our MiM employment rate was 95% within 3 months of graduation*; the majority of graduates choosing to work in consulting or financial services.

As well as a renowned qualification from a world-class business school, you also gain access to the School's network of more than 34,000 global alumni – a community that offers support and opportunities throughout your career.

For more information visit www.london.edu/mm, email mim@london.edu or give us a call on +44 (0)20 7000 7573.

* Figures taken from London Business School's Masters in Management 2010 employment report



7 Envoi

We are a rock revolving
Around a golden sun
We are a billion children rolled into one
So when I hear about the hole in the sky
Saltwater wells in my eyes

We climb the highest mountains
We'll make the desert bloom
We're so ingenious we can walk on the moon
But when I hear 'bout how the forests have died
Saltwater wells in my eyes

I have lived for love, but now that's not enough
For the world I love is dying, and now I'm crying
Time is not a friend, 'cause friends we're out of time
And it's slowly passing by
Right before our eyes

Saltwater – Julian Lennon

8 Endnotes

1. The title refers to a possible future spring season in which all bird songs would have silenced because of an overload of pesticides in the food chain.
2. Nevertheless, see 3.2 Carbon dioxide and ocean acidification.
3. Sometimes also denoted Pow, e.g. by GESAMP (**Error! Reference source not found.**).
4. Antifouling agents are added to paints covering the outside or maritime structures to avoid (excessive) growth of organisms on them. Such a colonisation would facilitate the onset of corrosion and increase the drag on ship's hulls.
5. Due to an inhibition of nitrification by oxygen, the process usually does not occur in the euphotic (upper) layers of the ocean, but only much deeper.
6. Environmental law of conservation of misery: the idea that an environmental burden can never be resolved, only transferred from system to system. Cleaning a soil requires an enormous input of water (which will then be polluted); getting rid of waste plastic either requires a landfill (soil pollution) or the more drastic combustion of the material (producing CO₂, hence adding to global warming). Cradle to cradle thinking (McDonough and Braungart 2002) turns waste material into a resource; however, this requires energy.
7. A full analysis lies outside the scope of this tekst. The interested reader can find a critical analysis of these claims on http://penelope.uchicago.edu/~grout/encyclopaedia_romana/wine/leadpoisoning.html and on <http://www.epa.gov/history/topics/perspect/lead.html>.
8. around 1000 million liter, as 1 barrel ≈ 119 liter.
9. around 775 million liter as 1 gallon ≈ 3.79 liter.
10. He tells his story on: http://www.ted.com/talks/lang/eng/capt_charles_moore_on_the_seas_of_plastic.html
11. See http://www.un.org/depts/los/reference_files/chronological_lists_of_ratifications.htm
12. This Treaty (dating from 1494) divided the world and the trading and colonizing rights linked to this ownership along the meridian 370 leagues west of the Cape Verde islands into a part for Portugal and a part for Spain.
13. Deadweight tonnage, a measure of how much weight a ship can safely carry.
14. Originally five, until air pollution was deemed so important as to warrant a separate annex (VI).
15. Nevertheless, the area seems to have been sufficiently resilient and has sustained the damage rather well, given the circumstances.
16. When a sea region requires extra protection due to its oceanographic or ecological constitution, MARPOL has the option to introduce this region as a special area. See also <http://www.imo.org/OurWork/Environment/PollutionPrevention/SpecialAreasUnderMARPOL/Pages/Default.aspx>.